

# FX-36

18-Channel Digital Proportional R/C System



S.BUS 2™



## INSTRUCTION MANUAL

**Futaba**®

1M23Z05501

*Digital Proportional R/C System*



# TABLE OF CONTENTS

<hr/>	
INTRODUCTION.....	4
●Declaration of Conformity (for EU).....	4
●Definitions of Symbols.....	5
●Safety Precautions (do not operate without reading) .....	5
<hr/>	
BEFORE USE .....	9
●Contents and technical specifications .....	9
●Self neutral stick .....	9
●Accessories.....	10
●Transmitter controls.....	11
●Transmitter's antenna .....	12
●Switch (SA-SH).....	13
●Volume .....	14
●Liner Slider .....	14
●Rotary Trims (T1-T6).....	15
●Installing/removing the battery .....	16
●Transmitter battery .....	17
●How to turn transmitter power ON/OFF .....	18
●Touch Panel.....	19
●H/E (Home/Exit) and U/M (User menu/Servo monitor).....	19
●Panel lock .....	20
●RF off mode .....	20
●Monitor LED display.....	21
●Stick control .....	21
Stick control (Airplane Example).....	22
Stick control (Helicopter Example) .....	23
Stick control (Multicopter Example).....	24
●Stick Adjustment .....	25
●Through hollow stick lever .....	26
●Adjustment of Throttle Stick (Ratchet).....	27
●Connector/Plug .....	29
●SD card .....	30
●Receiver nomenclature.....	31
●Receiver's antenna installation.....	33
●Safety precautions when installing servos...	34
●S.BUS/S.BUS2 Installation .....	35
●S.BUS Wiring example.....	36
●S.BUS2 System .....	37
●S.BUS/S.BUS2 device setting .....	38
<hr/>	
BASIC OPERATION .....	39
●Home screen .....	39
●Link procedure .....	40
●After setting.....	41
●If the receiver's voltage does not display on the transmitter .....	42
●Range testing your R/C system.....	43
<hr/>	
Model Basic Setting Procedure.....	44
Airplane.....	44
Helicopter.....	46
Servos connection by model type.....	49
<hr/>	
SYSTEM MENU .....	55
Display.....	56
Sound volume .....	57
Date and Time.....	57
H/W setting .....	58
Battery.....	59
Range check .....	59(→43)
S.Bus servo .....	60
Information .....	63
<hr/>	
LINKAGE MENU .....	64
Servo monitor .....	65
Model select .....	66
Model type .....	69
Servo reverse.....	71
End point.....	72
Servo speed .....	73
Sub-trim .....	73
Function .....	74
Fail safe .....	76
System type .....	77
Trim setting (T1-T6) .....	79
Throttle cut .....	80

## TABLE OF CONTENTS

Idle down.....	81	Elevator → Camber .....	134
Swash ring (Heli only).....	82	Camber mixing .....	135
Swash (Heli only, except H-1).....	83	Airbrake → ELE .....	137
Stick alarm.....	85	Camber flap → ELE.....	138
Timer .....	86	Rudder → Aileron .....	139
Function name .....	88	Rudder → Elevator .....	140
Telemetry system .....	89	Butterfly .....	141
Sensor .....	91	Trim mix 1/2.....	144
Telemetry.....	94	Snap roll (Airplane only).....	145
Telemetry:Receiver [Battery].....	95	Air brake (Airplane only).....	146
Telemetry:Receiver [Ext-batt].....	96	Gyro .....	147
Telemetry:Temperature .....	97	Ailevator.....	149
Telemetry:RPM sensor .....	98	Acceleration .....	150
Telemetry:Altitude .....	99	Motor .....	151
Telemetry:Altitude [Variometer] .....	100	V-tail .....	152
Telemetry:Voltage [Battery].....	103	Winglet .....	153
Telemetry:Voltage [Ext-batt].....	104		
Telemetry:GPS [Distance] .....	105	<b>MODEL MENU (Helicopter)</b>	
Telemetry:GPS [Speed].....	107	Pitch curve .....	155
Telemetry:GPS [Altitude, Variometer, Position]	108	Throttle curve.....	158
Telemetry:Servo sensor [Current] .....	109	Acceleration .....	160
Telemetry:Servo sensor [Temperature, Angle]	110	Throttle hold .....	161
Telemetry:Current sensor [Current].....	111	Swash mixing.....	162
Tele. setting (Telemetry setting) .....	112	Throttle mixing.....	163
Trainer.....	114	Pitch → Needle.....	164
Warning setting .....	117	Pitch → Rudder (Revolution mixing).....	165
User menu setting.....	118	Gyro (Helicopter) .....	166
Data reset .....	119	Governor .....	168
<b>MODEL MENU (Common functions)</b> .....	120		
Condition select .....	121	<b>Common Operations used in function setup</b>	
AFR .....	123	screen.....	170
Dual rate.....	124	●Operations value setting.....	170
Program, mixes.....	125	●Operations related to flight conditions .....	170
		●Operations related to fine tuning VR.....	171
		●Operations related to servo speed .....	172
<b>MODEL MENU (Airplane/Glider/Multicopter)</b>		●Curve setting operation.....	173
Aileron differential.....	129	●Switch selection method .....	177
Flap setting.....	130	●Updating .....	181
AIL → Camber flap.....	131	●Model data conversion .....	183
AIL → Brake flap .....	132		
Aileron → Rudder .....	133		

# INTRODUCTION

Thank you for purchasing a Futaba® FASSTest-2.4GHz\* FX-36 series digital proportional R/C system. This system is extremely versatile and may be used by beginners and pros alike. In order for you to make the best use of your system and to fly safely, please read this manual carefully. If you have any difficulties while using your system, please consult the manual, our online Frequently Asked Questions (on the web pages referenced below), your hobby dealer, or the Futaba Service Center.

\*FASSTest: Futaba Advanced Spread Spectrum Technology extend system telemetry

Due to unforeseen changes in production procedures, the information contained in this manual is subject to change without notice.

**Support and Service:** It is recommended to have your Futaba equipment serviced annually during your hobby's "off season" to ensure safe operation.

## Declaration of Conformity (for EU)

Hereby, Futaba Corporation declares that the radio equipment type is in compliance with Directive 2014/53/EU. The full text of the EU declaration of conformity is available at the following internet address:

**<http://www.rc.futaba.co.jp/english/dl/declarations.html>**



## Precautions

### Application, Export, and Modification Precautions.

1. This product is only designed for use with radio control models. Use of the product described in this instruction manual is limited to radio control models.
2. Export precautions:
  - a) When this product is exported, it cannot be used where prohibited by the laws governing radio waves of the destination country.
  - b) Use of this product with other than models may be restricted by Export and Trade Control Regulations.
3. Modification, adjustment, and parts replacement:

Futaba is not responsible for unauthorized modification, adjustment, or replacement of parts on this product.

  - No part of this manual may be reproduced in any form without prior permission.
  - The contents of this manual are subject to change without prior notice.
  - The contents of this manual should be complete, but if there are any unclear or missing parts please contact a Futaba Service Center.
  - Futaba is not responsible for the use of this product by the customer.
  - Company and product names in this manual are trademarks or registered trademarks of the respective company.

### For safe use

Please observe the following precautions to ensure safe use of this product at all times.

Meaning of Special Markings:

The parts of this manual indicated by the following marks require special attention from the standpoint of safety.

- ⚠ DANGER** - Procedures which may lead to dangerous conditions and cause death/serious injury if not carried out properly.
- ⚠ WARNING** - Procedures which may lead to a dangerous condition or cause death or serious injury to the user if not carried out properly, or procedures where the probability of superficial injury or physical damage is high.
- ⚠ CAUTION** - Procedures where the possibility of serious injury to the user is small, but there is a danger of injury, or physical damage, if not carried out properly.

⊘ = Prohibited    ⓘ = Mandatory

**WARNING:** Always keep electrical components away from small children.

## Flying Precautions

### ⚠ WARNING

⊘ **Never grasp the transmitter antenna while flying.**

- The transmitter output may drop drastically.

ⓘ **Always make sure that all transmitter stick movements operate all servos properly in the model prior to flight. Also, make sure that all switches, etc. function properly as well. If there are any difficulties, do not use the system until all inputs are functioning properly.**

⊘ **Never fly in range check mode.**

- In the dedicated range test range check mode, the transmitter output range is reduced and may cause a crash.

⊘ **While operating, never touch the transmitter with, or bring the transmitter near, another transmitter, a cellphone, or other wireless devices.**

- Doing so may cause erroneous operation.

⊘ **Do not point the antenna directly toward the aircraft during flight.**

- The antenna is directional and the transmitter output is weakest. (The strength of the radio waves is greatest from the sides of the antenna.)

⊘ **Never fly on a rainy day, when the wind is strong, or at night.**

- Water could lead to failure or improper functionality and poor control of the aircraft which could lead to a crash.

⊘ **Never turn the power switch off during flight or while the engine or motor is running.**

- Operation will become impossible and the aircraft will crash. Even if the power switch is turned on, operation will not begin until transmitter and receiver internal processing is complete.

⊘ **Do not start the engine or motor while wearing the neck strap.**

- The neck strap may become entangled with the rotating propeller, rotor, etc. and cause a serious injury.

⊘ **Do not fly when you are physically impaired as it could pose a safety hazard to yourself or others.**

---

### ⊘ Do not fly at the following places:

- Near another radio control flying field.
  - Near or above people.
  - Near homes, schools, hospitals or other places where people congregate.
  - Near high voltage lines, high structures, or communication facilities.
- 

### ⊘ Do not touch the engine, motor, or ESC during and immediately after use.

- These items may become hot during use.
- 

### ⚠ For safety, fly so that the aircraft is visible at all times.

- Flying behind buildings or other large structures will not only cause you to lose sight of the aircraft, but also degrade the RF link performance and cause loss of control.
- 

### ⚠ From the standpoint of safety, always set the fail safe function.

- In particular, normally set the throttle channel to idle. For a helicopter, set the throttle channel to maintain a hover.
- 

### ⚠ When flying, always return the transmitter setup screen to the Home screen.

- Erroneous input during flight is extremely dangerous.
- 

### ⚠ Always check the remaining capacity of the transmitter and receiver batteries before each flying session prior to flight.

- Low battery capacity will cause loss of control and a crash.
- 

### ⚠ Always check operation of each control surface and perform a range test before each flying session. Also, when using the trainer function, check

### the operation of both the teacher and student transmitter.

- Even one incorrect transmitter setting or aircraft abnormality can cause a crash.
- 

### ⚠ Before turning on the transmitter:

1. Always move the transmitter throttle stick position to the minimum (idle) position.

2. Turn on the transmitter first and then the receiver.

---

### ⚠ When turning off the transmitter's power switch after the engine or motor has stopped (state in which it will not rotate again):

1. Turn off the receiver power switch.

2. Then turn off the transmitter power switch.

- If the power switch is turned on/off in the opposite order, the propeller may rotate unexpectedly and cause a serious injury.

- Also always observe the above order when setting the fail safe function.
- 

### ⚠ When adjusting the transmitter, stop the engine except when necessary. In the case of a motor, disconnect the wiring that allows it to continue operation. When doing so, please exercise extreme caution. Ensure that the aircraft is secured and that it will not come into contact with anything or anyone. Ensure that the motor will not rotate prior to making any adjustments.

- Unexpected high speed rotation of the engine may cause a serious injury.
- 

## Battery and Charger Handling Precautions

### ⚠ DANGER

⊘ Do not recharge a battery that is damaged, deteriorated, leaking electrolyte, or wet.

⊘ Do not use the charger in applications other than as intended.

⊘ Do not allow the charger or battery to become wet.

- Do not use the charger when it or your hands are wet. Do not use the charger in humid places.
- 

⊘ Do not short circuit the battery.

⊘ Do not solder, repair, deform, modify, or disassemble the battery and/or battery charger.

⊘ Do not drop the battery into a fire or bring it near a fire.

⊘ Do not charge and store the battery in direct sunlight or other hot places.

⊘ Do not charge the battery if it is covered with any object as it may become very hot.

⊘ Do not use the battery in a combustible environment.

- The combustibles may could ignite ignite and cause an explosion or fire.
- 

⚠ Always charge the battery before each flying session.

- If the battery goes dead during flight, the aircraft will crash.
- 

⚠ Charge the battery with the dedicated charger supplied with the set.

- Charging the battery past the specified value may cause a fire, combustion, rupture, or liquid leakage. When quick charging, do not charge the battery above 1C.
- Do not charge the battery while riding in a vehicle. Vibration will prevent normal charging.

**⚠ Insert the power cord plug firmly into the receptacle up to its base.**

**⚠ Always use the charger with the specified power supply voltage.**

- Use the special charger by connecting it to a proper power outlet.

#### **⚠ WARNING**

**⊘ Do not touch the charger and battery for any length of time during charging.**

- Doing so may result in burns.

**⊘ Do not use a charger or battery that has been damaged.**

**⊘ Do not touch any of the internal components of the charger.**

- Doing so may cause electric shock or a burn.

**⊘ If any abnormalities such as smoke or discoloration are noted with either the charger or the battery, remove the battery from the transmitter or charger and disconnect the power cord plug and do not use the charger.**

- Continued use may cause fire, combustion, generation of heat, or rupture.

**⊘ Do not subject the batteries to impact.**

- Doing so may cause fire, combustion, generation of heat, rupture, or liquid leakage.

#### **⚠ CAUTION**

**⊘ Do not use the battery with devices other than the corresponding transmitter.**

**⊘ Do not place heavy objects on top of the battery or charger. Also, do not place the battery or charger in any location where it may fall.**

- Doing so may cause damage or injury.

**⊘ Do not store or use the battery and charger where it is dusty or humid.**

- Insert the power cord plug into the receptacle only after eliminating the dust.

**⊘ After the transmitter has been used for a long time, the battery may become hot. Immediately remove it from the transmitter.**

**⚠ If the battery liquid should get in your eyes, do not rub your eyes, but immediately wash them with tap water or other clean water and get treated by a doctor.**

- The liquid can cause blindness.

**⚠ Use and store the battery and battery charger in a secure location away from children.**

- Not doing so may cause electric shock or injury.

**⚠ If the battery leaks liquid or generates an abnormal odor, immediately move it to a safe place for disposal.**

- Not doing so may cause combustion.

**⚠ If the battery liquid gets on your skin or clothing, immediately flush the area with tap water or other clean water.**

- Consult a doctor. The liquid can cause skin damage.

**⚠ After the specified charging time has elapsed, end charging and disconnect the charger from the receptacle.**

**⚠ When recycling or disposing of the battery, isolate the terminals by covering them with tape.**

- Short circuit of the terminals may cause combustion, generation of heat or rupture.

- Not doing so may cause a burn.

**⊘ Do not charge the battery in extreme temperatures.**

- Doing so will degrade the battery performance. An ambient temperature of 10°C to 30°C (50 °F to 86 °F) is ideal for charging.

**⊘ Unplug the charger when not in use.**

**⊘ Do not bend or pull the cord unreasonably and do not place heavy objects on the cord.**

- The power cord may be damaged and cause combustion, generation of heat, or electric shock.

## SD Card (Commercial Product) Handling Precautions

\*Read the instruction manual supplied with the SD card for details.

### ⚠ WARNING

- ⊘ Never disassemble or modify the SD card.
- ⊘ Do not bend, drop, scratch or place heavy objects on the SD card.
- ⊘ If smoke or an abnormal odor emanates from the card, immediately turn off the transmitter power.

### ⚠ CAUTION

❗ Since the SD card is an electronic device, be careful of static electricity.

■ Static electricity may cause erroneous operation or other trouble.

⊘ Do not use the SD card near radio and television sets, audio equipment, motors and other equipment that generates noise.

■ Doing so may cause erroneous operation.

⊘ Do not store the SD card in the following places:

- Where the humidity is high
- Where the temperature difference is severe
- Where it is very dusty
- Where the card will be exposed to shock and vibration
- Near speakers and other magnetic devices

⊘ Do not use the SD card where it may be exposed to water, chemicals, oil, or other fluids.

■ Doing so may cause a fire or electric shock by short circuiting.

⊘ Do not insert foreign matter into the transmitter card slot.

■ Doing so may cause erroneous operation.

⊘ Do not expose the card to shock and vibration and do not remove the card from the card slot while data is being written or read.

■ The data may be damaged or lost.

#### ● Recorded data

The data recorded on the SD card cannot be compensated regardless of the contents or cause of the trouble or obstruction. Futaba does not perform data restoration or recovery work.

## Storage and Disposal Precautions

### ⚠ WARNING

⊘ Keep wireless equipment, batteries, aircraft, etc. away from children.

### ⚠ CAUTION

⊘ Do not store wireless devices in the following places:

- Where it is extremely hot (40°C [104 °F] or higher) or cold (-10°C [14 °F] or lower)
- Where the equipment will be exposed to direct sunlight
- Where the humidity is high
- Where vibration is prevalent
- Where it is very dusty
- Where the device may be exposed to steam and heat

❗ When the device will not be used for a long time, remove the batteries from the transmitter and aircraft and store them in a dry place where the temperature is between 0°C and 30°C [32 °F and 86 °F].

■ Leaving batteries inside your model and radio when they are not being used for long periods will result in battery deterioration, liquid leakage and other damage.

## Other Precautions

### ⚠ CAUTION

⊘ Do not directly expose plastic parts to fuel, oil, exhaust gas, etc.

■ If left in such an environment, the plastic may be damaged.

■ Since the metal parts of the case may corrode, always keep them clean.

❗ Always use genuine Futaba products such as transmitter, receiver, servo, ESC, battery, etc.

■ Futaba is not responsible for damage sustained by combination with parts other than Futaba Genuine Parts. Use the parts specified in the instruction manual and catalog.

# Contents and Technical Specifications

(Specifications and ratings are subject to change without notice.)

Your FX-36 includes the following components:

- FX-36 transmitter
- R7008SB Receiver
- 6.0V NiMH battery 2500mAh and charging lead
- Switch harness
- 2 stick extensions M4 for use in tray
- Aluminium case
- Mini driver
- Swing arm stopper and set screw

\*The set contents depend on the type of set.

## Transmitter FX-36

(2-stick, 18-channel, FASSTest-2.4GHz system)

Transmitting frequency: 2.4GHz band

System: FASSTest18CH, FASSTest12CH, FASST MULT, FASST 7CH, T-FHSS, S-FHSS, switchable

Power requirement: 6.0V-7.4V battery

Frequency band: 2.4GHz

RF power output : 100mW EIRP

## Receiver R7008SB

(FASSTest-2.4GHz system, Dual Antenna Diversity, S.BUS/S.BUS2 system)

Power requirement: 3.7V-7.4V battery or regulated output from ESC, etc. (\*1)

Size: 0.98 x 1.86 x 0.56 in. (24.9 x 47.3 x 14.3 mm)

Weight: 0.38 oz. (10.9g)

Frequency band: 2.4GHz

RF power output: 25mW EIRP

(\*1) When using ESCs make sure that the regulated output capacity meets your usage application.

**Note: The battery in the FX-36 transmitter does not arrive already attached to the battery connector. Please connect the battery connector before use.**

## Self neutral stick

### Throttle stick warning

**Ratchet type**  
(General transmitter)

The throttle stick doesn't return neutrally.

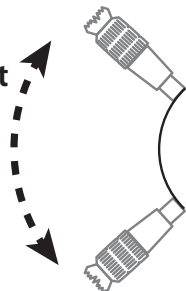

**Self neutral type**  
(FX-36)

The throttle stick returns neutrally by a spring.

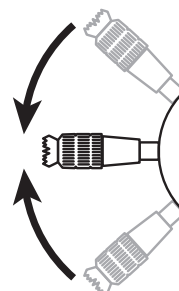

### **WARNING**

You cannot use the self-neutral throttle stick for R/C airplanes, helicopters, and certain multi-copters. Allowing the engine/motor to reach middle speed via automatic throttle stick return is very dangerous. If using the FX-36 for R/C airplanes and helicopters, you must change the throttle stick to the ratchet type.

---

## Accessories



**The following additional accessories are available from your dealer. Refer to a Futaba catalog for more information:**

- For longer flight time, there are 2SLiFe or 2S LiPo batteries available. Pay attention, to charge them with the correct charging method and adjust the low voltage alert according to the battery type.
- Trainer cord - the optional training cord may be used to help a beginning pilot learn to fly easily by placing the instructor on a separate transmitter. Note that the FX-36 transmitter may be connected to another FX-36 system, as well as to any other models of Futaba transmitters. The FX-36 transmitter uses one of the three cord plug types according to the transmitter connected.
- Servos - there are various kinds of servos. Please choose the Futaba servos that best suit your model and purpose. If you utilize an S.BUS system, you should choose an S.BUS servo. An analog servo cannot be used if "FASSTest12CH mode" is used.
- Telemetry sensor - please purchase an optional sensor, in order to utilize bidirectional communication system and to acquire the information from a model high up in the sky.  
[Temperature sensor : SBS-01T/TE] [Altitude sensor : SBS-01/02A] [RPM sensor magnet type : SBS-01RM] [RPM sensor optical type : SBS-01RO] [RPM sensor brushless motor type : SBS-01RB] [GPS sensor : SBS-01/02G] [Voltage sensor : SBS-01V] [S.BUS servo sensor : SBS-01S] [Current sensor : SBS-01C]
- Y-harnesses, servo extensions, hub,etc - Genuine Futaba extensions and Y-harnesses, including a heavy-duty version with heavier wire, are available to aid in your larger model and other installations.
- Gyros - a variety of genuine Futaba gyros is available for your aircraft or helicopter needs.
- Governor - for helicopter use. Automatically adjusts throttle servo position to maintain a constant head speed regardless of blade pitch, load, weather, etc.
- Receivers - various models of Futaba receivers may be purchased for use in other models. (Receivers for FASSTest and FASST, T-FHSS, S-FHSS types are available.)
- SBD-2, S.BUS decoder -The SBD-2 is a converter for using conventional servos (other than an S.BUS servo) with the S.BUS/S.BUS2 system. The SBD-2 connects to the receiver output of an S.BUS/S.BUS2 system and eight servos can be used. SBD-2 can change the output CH by selecting from 9 groups using a rotary switch. SBD-2 can use EXT battery (for servos).
- Transmitter tray P-TT01 and neck strap P-TT01/NSF
- Different switches
- 2 stick switches: momentary, 2-position or 3- position

# FX-36

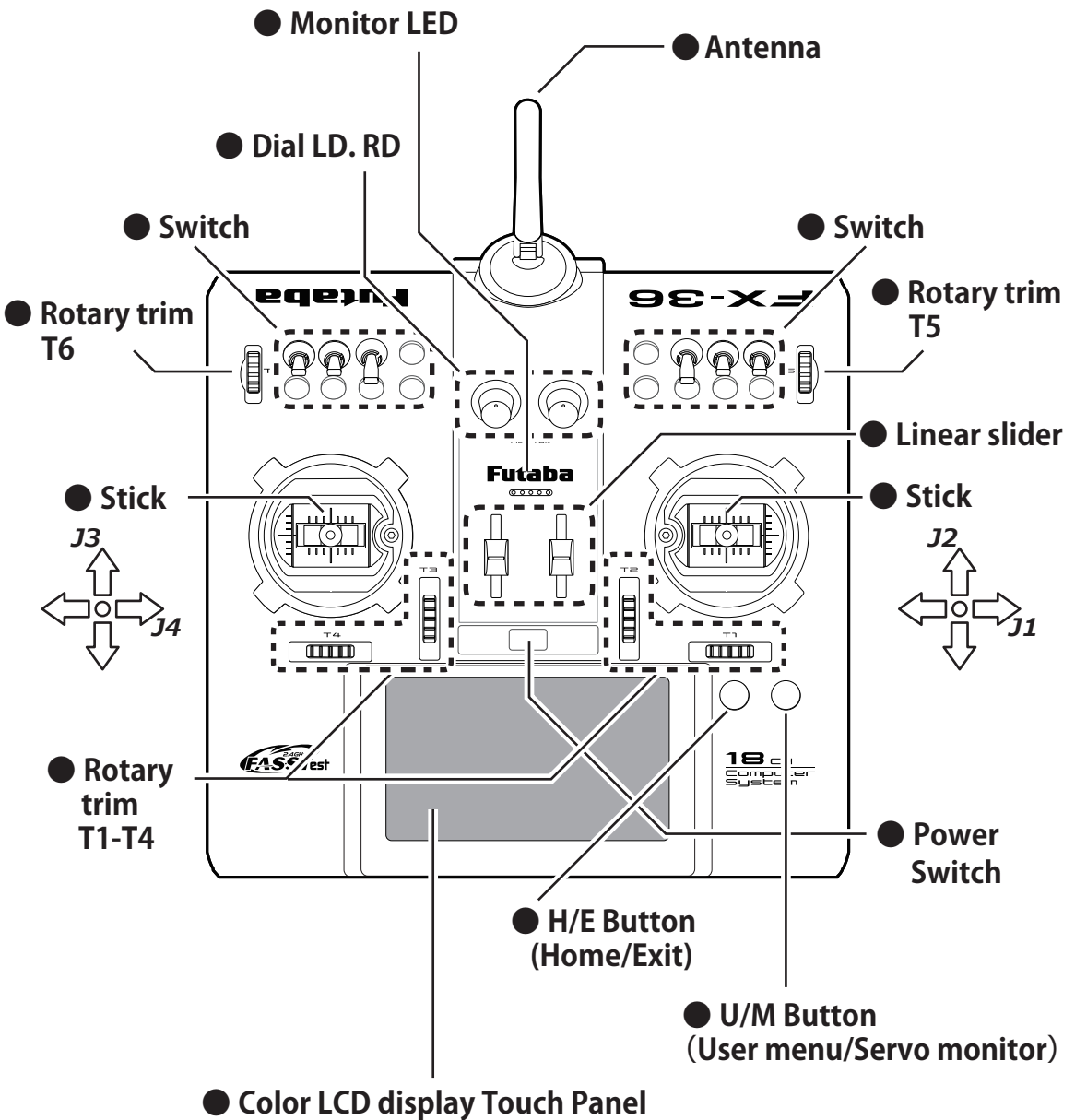

The panel displays shown in this manual may vary from your own, depending upon your model type. Panel displays may also vary as a result of version upgrades or other changes.

## Transmitter's antenna

As with all radio frequency transmissions, the strongest area of signal transmission is from the sides of the transmitter's antenna. As such, the antenna should not be pointed directly at the model. If your flying style creates this situation, easily move the antenna to correct this situation.

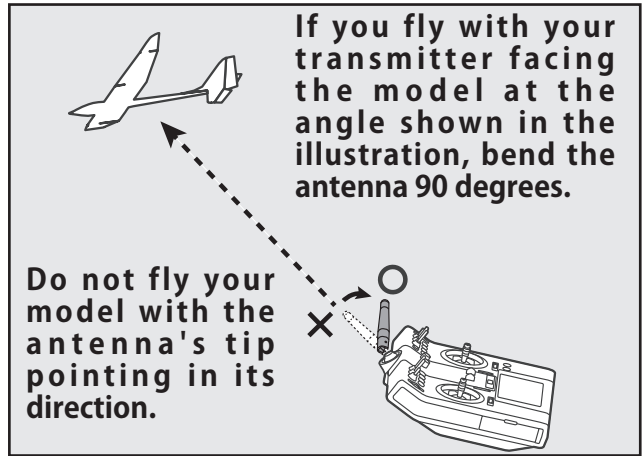
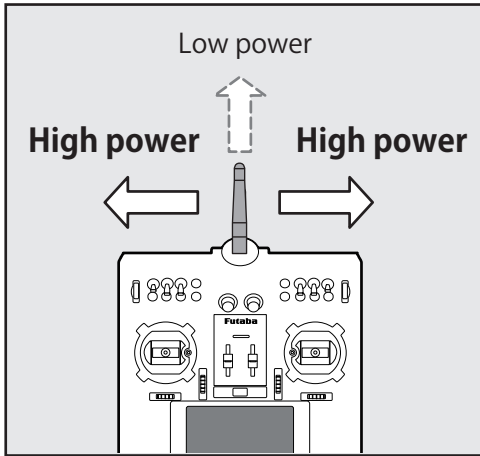

## Rotating antenna

The antenna can be rotated 90 degrees and angles 90 degrees. Forcing the antenna further than this can damage it. The antenna is not removable.

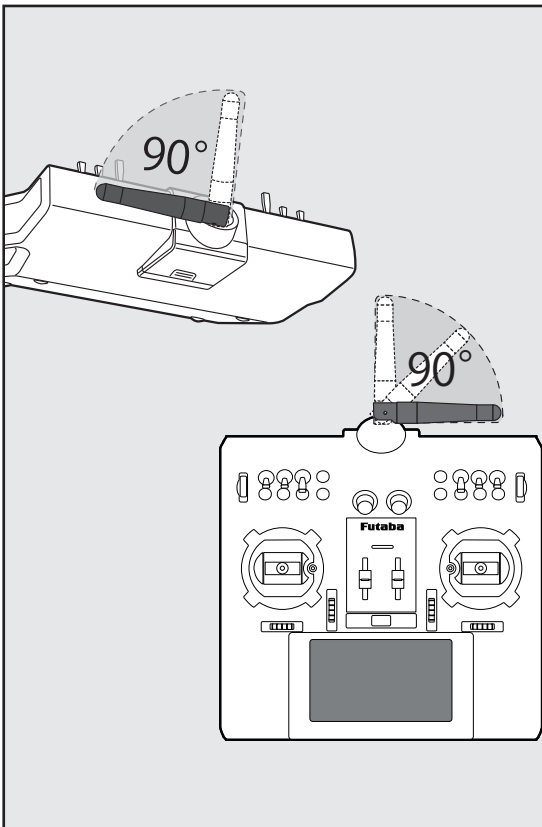

### ⚠ CAUTION

❗ Please do not grasp the transmitter's antenna during flight.

■ Doing so may degrade the quality of the RF transmission to the model.

⊘ Do not carry the transmitter by the antenna.

■ The antenna wire may break, making operation impossible.

⊘ Do not pull the antenna forcefully.

■ The antenna wire may break, making operation impossible.

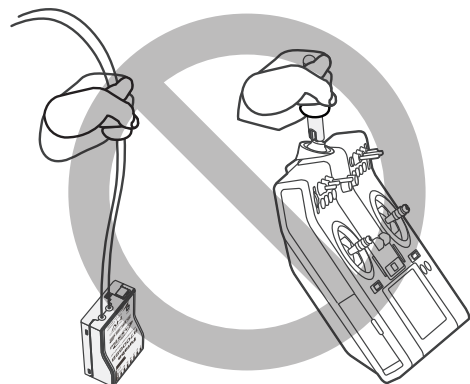



# Switch (SA-SH)

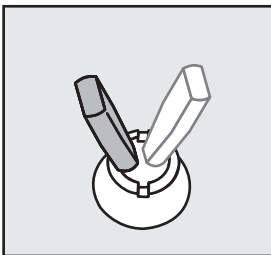
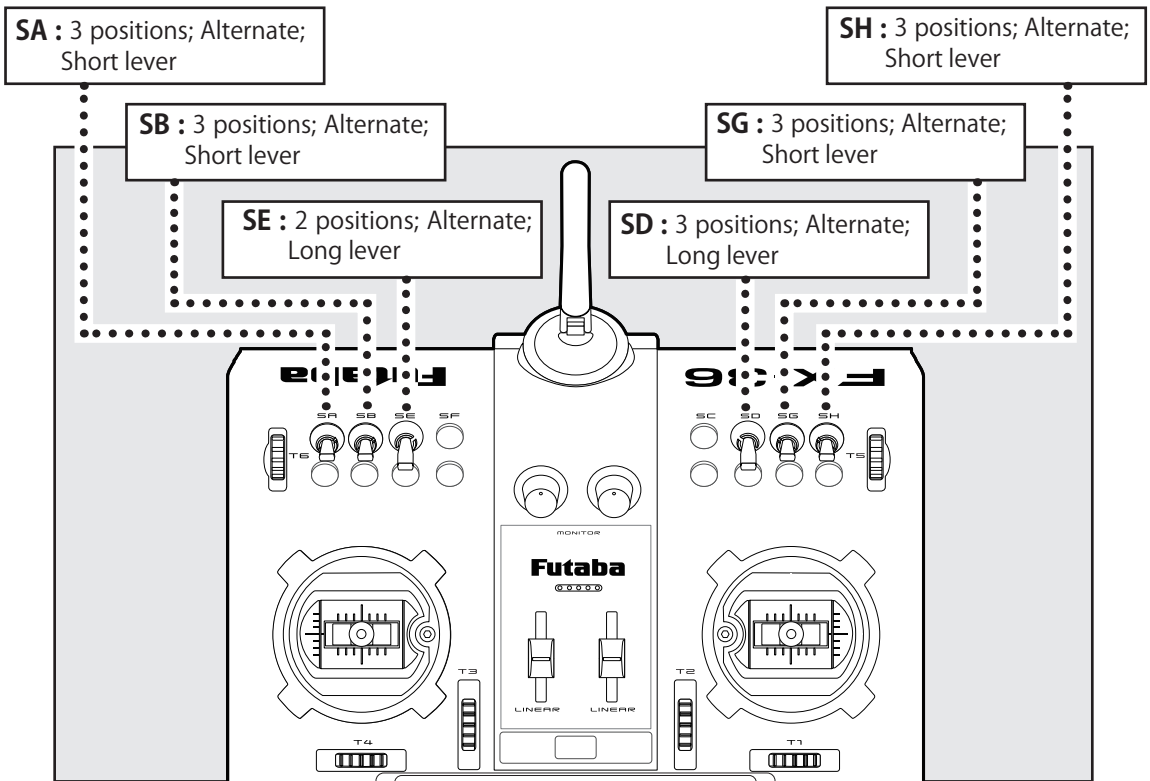

2 positions

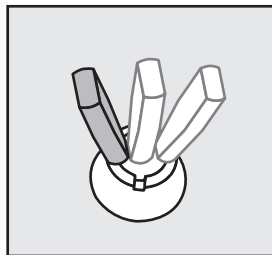

3 positions

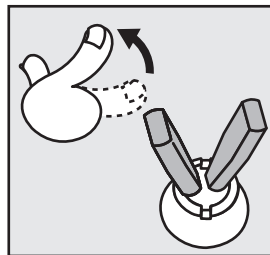

Alternate

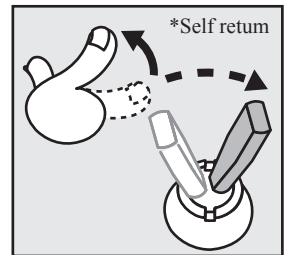

Momentary  
(Optional)

## Volume

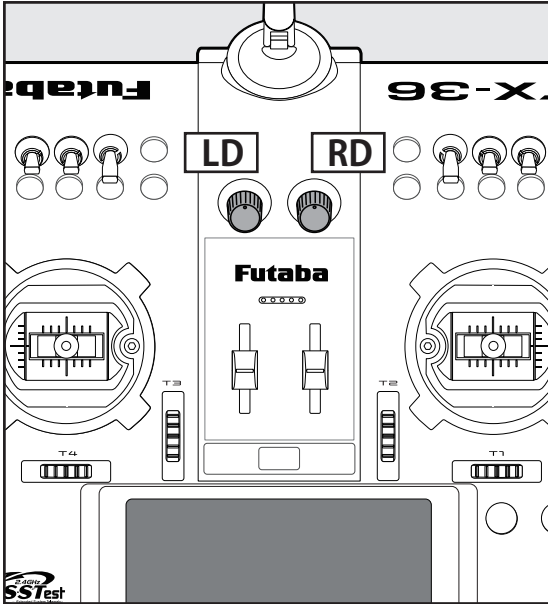

### LD (Left), RD (Right):

The volume LD and RD knobs allow analog input.

\*The FX-36 transmitter beeps when the volume knob reaches the center position.

\*You can use each setting screen of the mixing functions to select volumes and define the direction of movement.

## Liner Slider

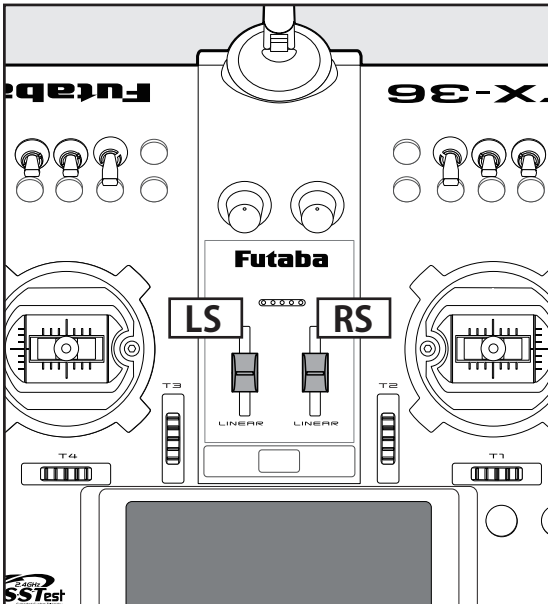

### LS (Left), RS (Right):

The Linear Slider LS and RS offer analog input.

\*The FX-36 transmitter beeps when the lever comes to the center.

\*You can select a slide lever and set the movement direction on the setting screen of mixing functions.

## Rotary Trims T1-T6

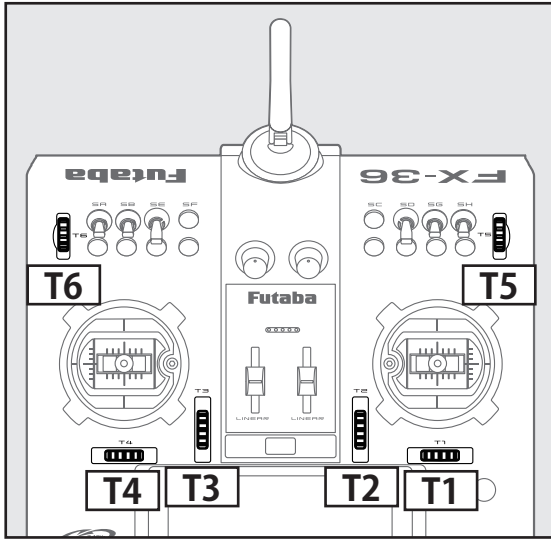

This transmitter is equipped with 6 rotary trims. In addition, when the trim position returns to the center, the tone will change. You can always monitor trim positions by referencing the LCD screen.

\*You can select the trim step amount and the display unit on the home screen on the T1-T6 setting screen within the linkage menu.

Note: The trim positions you have set will be stored in the non-volatile memory and will remain there.

The upper rotary trimmers T5 and T6 offer analog input.

\*You can select a slide lever and set the movement direction on the setting screen of mixing functions.

## Rotary trim operational example

\*Example Stick Mode2

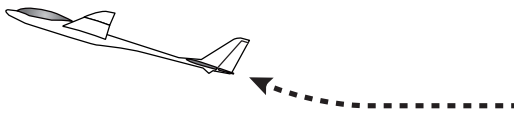

◆When the airplane goes up while the elevator stick is neutral.

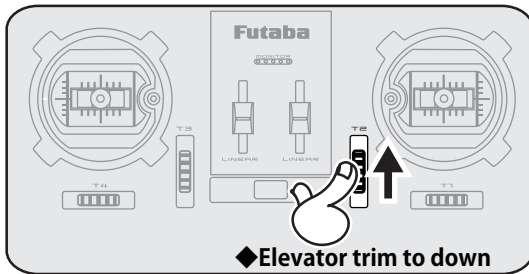

Elevator Neutral  
↓  
Elevator Down

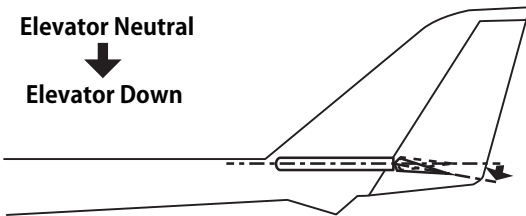

◆When the airplane dives while the elevator stick is neutral.

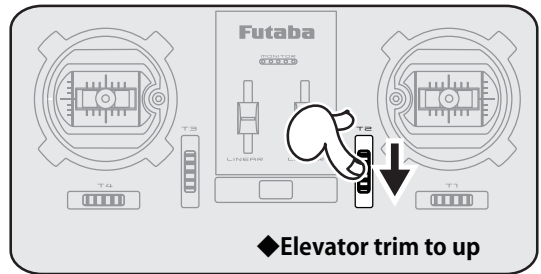

Elevator Neutral  
↓  
Elevator Up

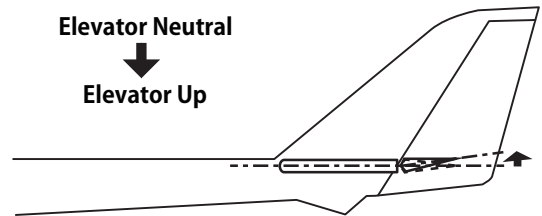

◆Adjust so that the airplane flies level.

# Installing/removing the battery

## Installing/removing the Rear case

① "OPEN" of a slider is pushed.

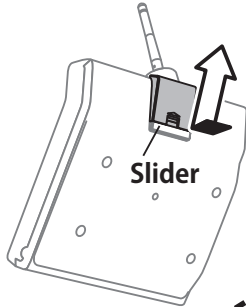

② It slides in the direction of an arrow.

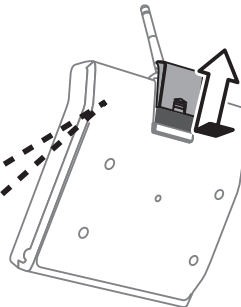

\*When a slider is raised, it is the structure which an internal stopper releases

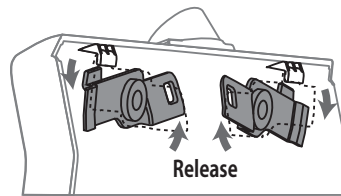
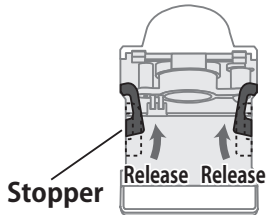

\* When shutting a case, a slider is lowered and a stopper is locked.

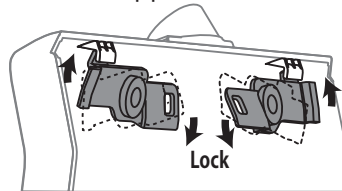
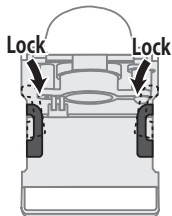

③ A rear case is removed in the direction of an arrow.

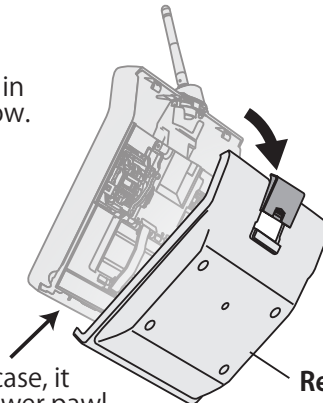

\* When shutting a case, it attaches from a lower pawl.

# Transmitter Battery

## Installing/removing the Battery

### Installation and removal of the transmitter battery

#### Attachment of the battery

1. Open the rear case.

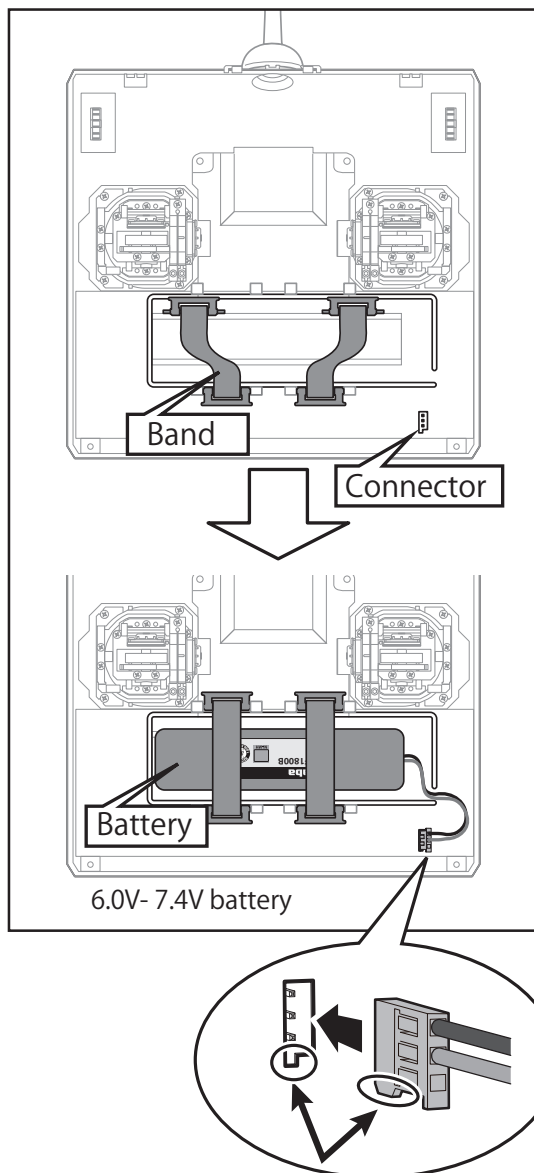

2. A battery is fixed using two bands.
3. Connect the battery connector.
4. Close the rear case completely.

#### Battery removal

**Note: If you remove the battery while the power is on, the data you have set will not be saved.**

1. Open the rear case.
2. Disconnect the battery connector.
3. Two bands are removed and the remove the battery.
4. Close the rear case completely.

#### **⚠ WARNING**

**⚠ Be careful not to drop the battery.**

**⚠ Never disconnect the battery connector from the FX-36 transmitter after turning off the power until the screen is completely blank and the transmitter has shut down completely.**

- \* Internal devices such as memories may be damaged.
- \* If there is any problem, the message "Backup Error" will be shown the next time when you turn on the power of the transmitter. Do not use the transmitter as it is. Send it to the Futaba service center.

#### **Charging the included battery:**

Charge the transmitter battery before using it for the first time. To do this, insert the transmitter charging lead into the charging socket of a NiMH charger correctly then connect the other end of the charging lead to the charging jack on the left side of FX-36 (see page 29). Start charging, as described in the manual of your charger. The transmitter must be switched off during charging.

#### **Note:**

**The charger must be able to charge 5-cell NiMH rechargeable batteries. The charging current must be limited to 1.5 A. Please refer to the user manual of the charger.**

## How to turn transmitter power ON/OFF

When turning on the power, the FX-36 transmitter will begin emitting RF automatically after it confirms the surrounding RF conditions. The status of the transmitter is displayed by LED at the upper part of the front of a FX-36.

\*If THR stick is high, a WARNING screen will appear. Another warning will appear if a power supply is attached. (In Multicopter mode, the THR position alarm will not appear.)

### Power ON

Throttle Stick Low

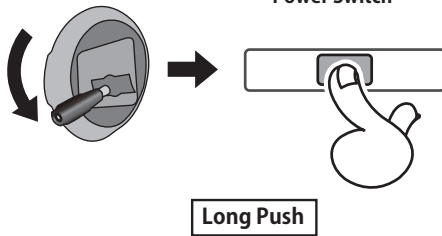

### Power OFF

Power Switch

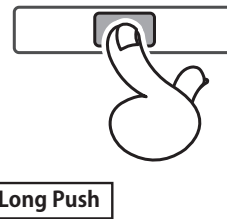

### If the "Thr position" alarm displays

\*If the throttle stick is in the high position when the power is turned ON

When the alarm activates, lower the throttle stick before turning the receiver power ON.

\*If the power is turned ON when the idle-up, air brake, etc., switches are ON, the above warning will display. Ensure the relevant switches are turned OFF.



If the power switches are turned off in the opposite order the model may unexpectedly run out of control and cause a very dangerous situation.

#### Turning on the power switches

1. Turn on the transmitter power switch.
2. Turn on the receiver or speed control power switch.

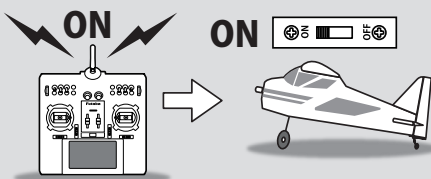

#### Turning off the power switches

- Always be sure the motor/engine is stopped.
- 1. Turn off the receiver or speed control power switch.
- 2. Then turn off the transmitter power switch.

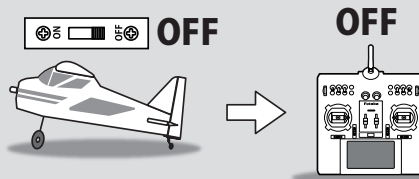

# Touch Panel

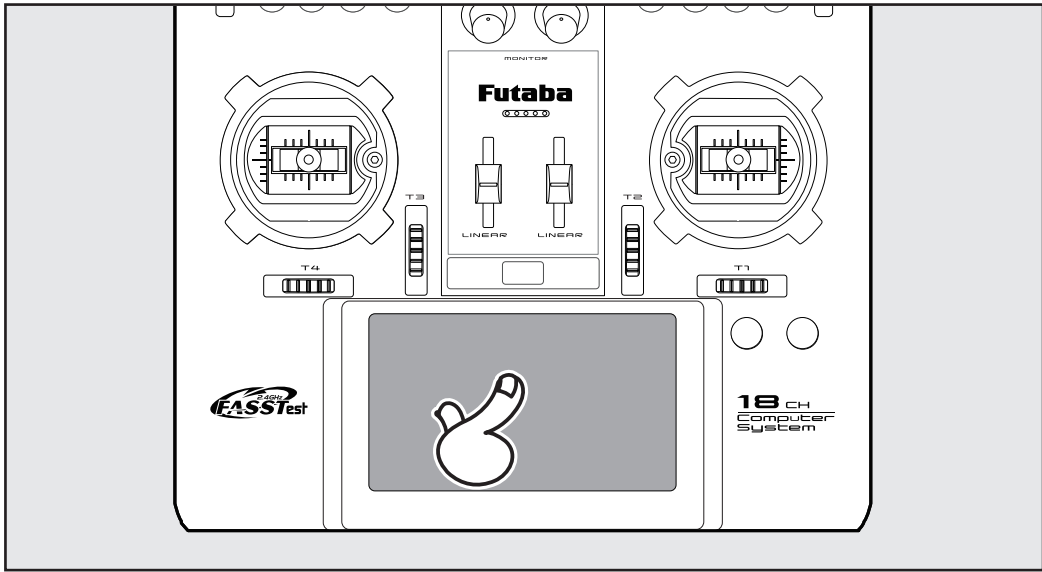

Tap the panel with your finger to enter data.

\*Plastic film is attached to the Touch Panel. Please be careful so that you don't scratch the Touch Panel with anything hard such as a metal object. Don't push the Touch Panel with excessive force or drop anything on the panel.

\*Although you may find some air bubbles under the plastic panel due to environmental changes such as temperature, it is not a defect and will cause no problems.

\*Color LED is made from many pixels. Some pixels hold lighting. Moreover, some pixels go out. And a screen may flicker. Such condition is the characteristics of color LED. It is not failure.

**EXP B**  
-100.0

Tapping the settings buttons for each value on the settings screen will cause value input buttons to appear at the top of the panel.

Pressing and holding a value will return it to its default setting.

Value input buttons display at the top of the panel.

Large change in value    Small change in value    Large change in value

## H/E (Home/Exit) and U/M (User menu/Servo monitor)

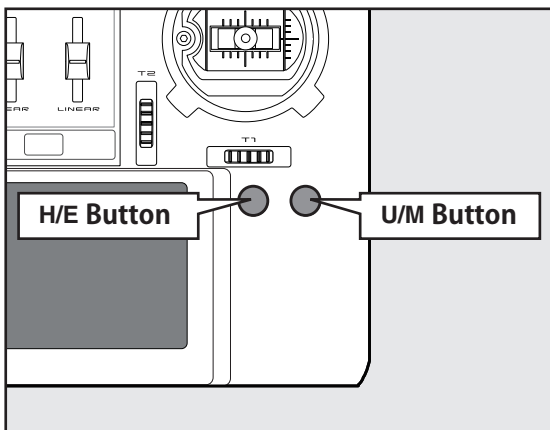

H/E	
Press	Return to the previous screen
Press and hold	Return to the home screen
Press from HOME screen.	To Telemetry display
Press and hold from HOME screen.	Panel lock / Lock release

U/M	
Press	To user menu display
Press and hold	To servo monitor display

## Panel lock

Temporarily activating this function makes it impossible to change data by mistakenly touching keys during flight.

### How to lock

1. The home screen is displayed.
2. Press the H/E button for about 1 second. "Key mark" is displayed and the keys disabled.

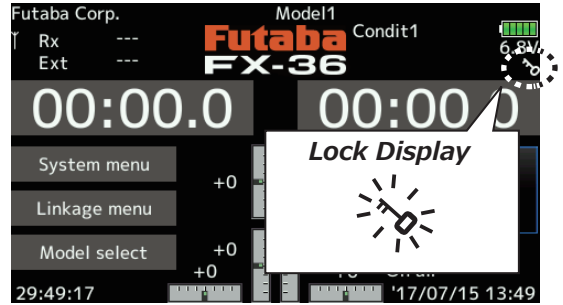
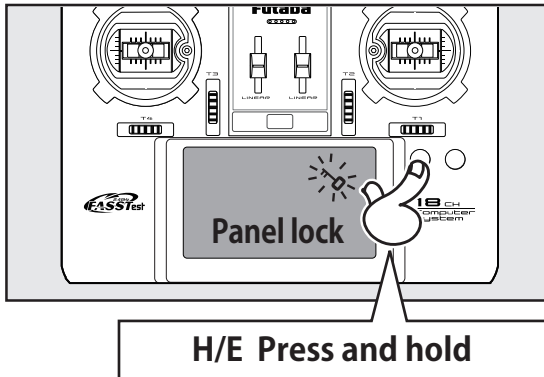

### How to unlock

1. Press the H/E button for about 1 second, and the panel will then become unlocked.

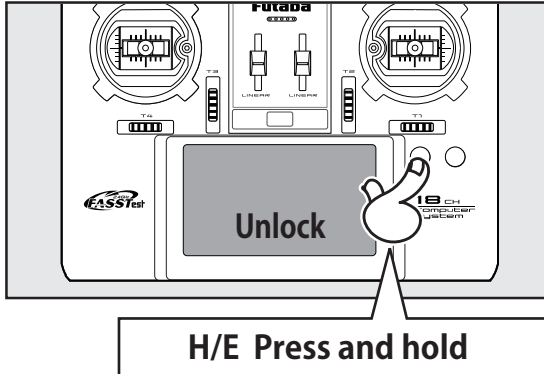

### CAUTION

- ! The FX-36's touch screen is very sensitive. To avoid accidentally activating it during a flight, it is suggested that it be locked. Due to the touch screen's sensitivity, allowing it to be touched during flight by a neck strap hook, servo extension, or even your hand could be dangerous. Please use the Touch Panel lock for added safety during flight.

## RF off mode

Model operation is not possible, but panel operation without RF signal transmission is allowed. (Reduces battery power consumption during set-up.)

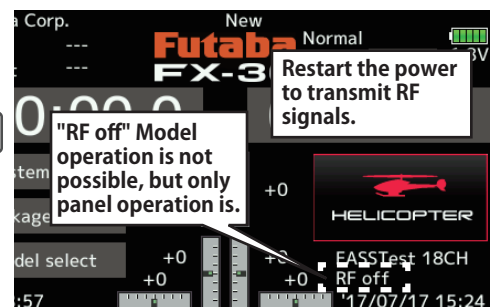
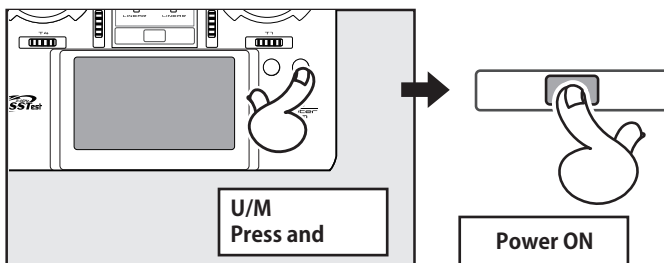



## Monitor LED display

The status of the transmitter is displayed by LED at the upper part of the front of a FX-36.

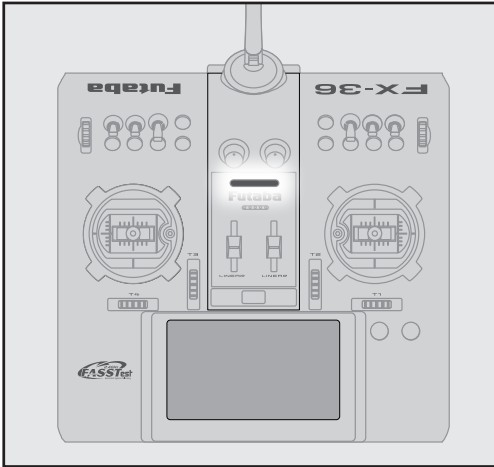

- ✧ FASSTest mode → Light Blue light
- ✧ FASST mode → Green light
- ✧ T-FHSS/S-FHSS mode → Yellow-green light
- ✧ RF-OFF → Violet light
- ✧ Starting → Red light
- ✧ Trainer Student → Blue light
- ✧ Range check mode → Slow blinking
- ✧ Receiver link mode → Fast blinking

## Stick control

\*Example Stick Mode2

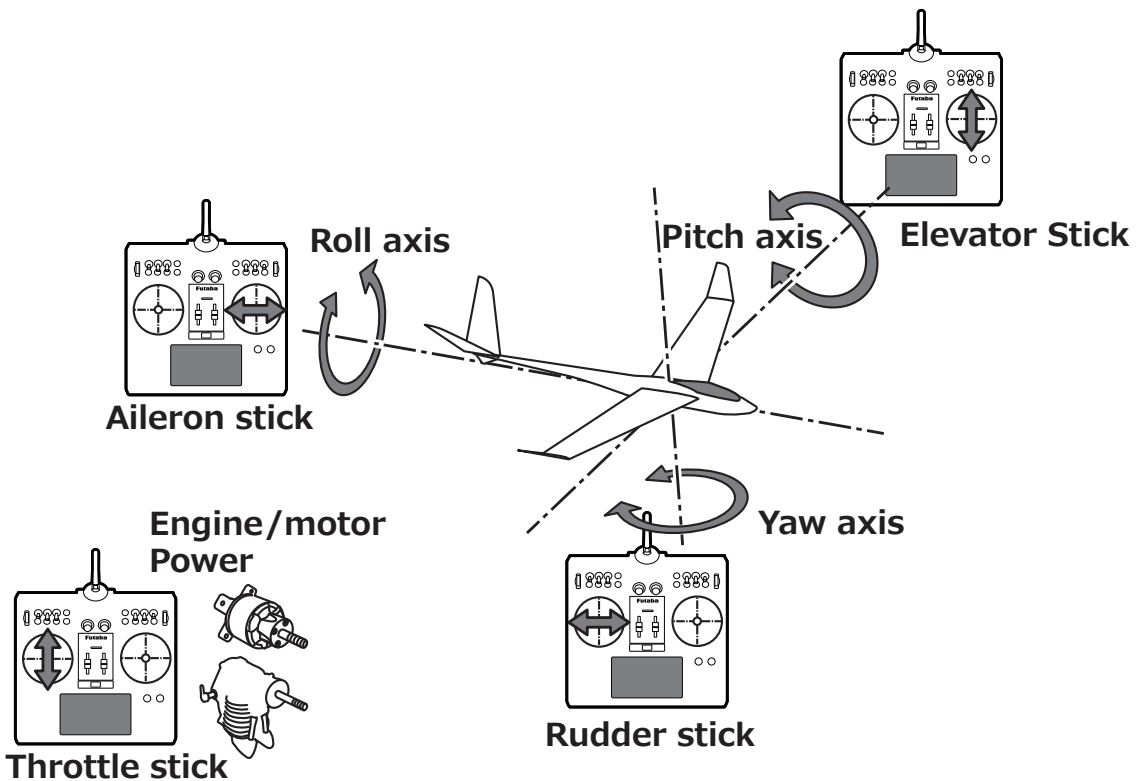

# Stick control : Airplane (Glider) Example

\*Example Stick Mode2

A general model example. (There is also a different operational model.)

### Roll Axis Control

**Right roll**  
The right aileron is up.  
The left aileron is down.

**Aileron stick**  
↓  
**To the right**

**Level flight**

**Neutral**

**Left roll**  
The left aileron is up.  
The right aileron is down.

**Aileron stick**  
↓  
**To the left**

### Pitch Axis Control

**Nose Up**

**Elevator stick**  
↓  
**UP**  
(moved to the bottom)

**Level flight**

**Neutral**

**Nose Down**

**Elevator stick**  
↓  
**DOWN**  
(moved to the top)

### Yaw Axis Control

**Nose Right**

**Rudder stick**  
↓  
**To the right**

**Neutral**

**Strait**

**Neutral**

**Nose Left**

**Rudder stick**  
↓  
**To the left**

### Throttle Control

**High throttle**

**Throttle stick**  
↓  
**HIGHT**  
(moved to the top)

**Middle**

**Throttle stick**  
↓  
**MIDDLE**  
(neutral)

**Low throttle**

**Throttle stick**  
↓  
**LOW**  
(moved to the bottom)

# Stick control : Helicopter Example

\*Example Stick Mode2

A general model example. (There is also a different operational model.)

### Roll Axis Control

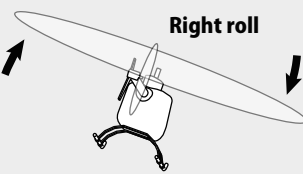
**Right roll**  
  
**Aileron stick**  
**To the right**

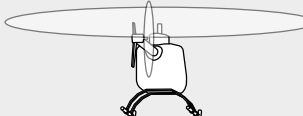
**Level flight**  
  
**Neutral**

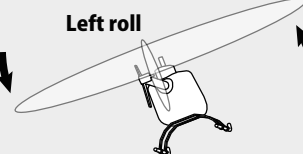
**Left roll**  
  
**Aileron stick**  
**To the left**

### Pitch Axis Control

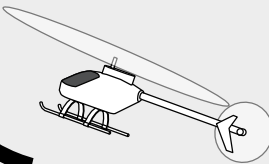
**Nose Up**  
  
**Elevator stick**  
**UP**  
 (moved to the bottom)

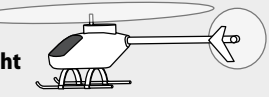
**Level flight**  
  
**Neutral**

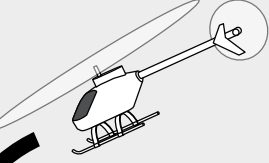
**Nose Down**  
  
**Elevator stick**  
**DOWN**  
 (moved to the top)

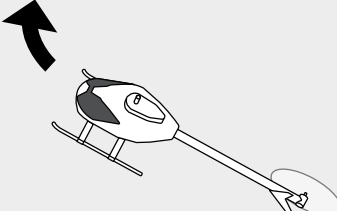

### Yaw Axis Control

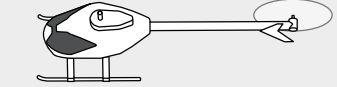
**Nose Right**  
  
**Rudder stick**  
**To the right**

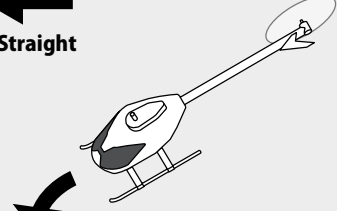

**Straight**  
  
**Neutral**

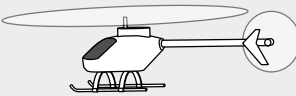
**Nose Left**  
  
**Rudder stick**  
**To the left**

### Throttle /Pitch Control

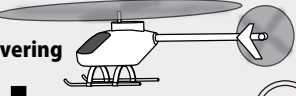
**Rise**  
  
**Pitch Up**  **High**  
**Throttle stick**  
**HIGHT**  
 (moved to the top)

**Hovering**  
  
**Throttle stick**  
**MIDDLE**  
 (neutral)

**Descent**  
  
**Pitch Down**  **Middle**  
**Throttle stick**  
**SLOW**  
 (moved to the bottom)

# Stick control : Multicopter Example

\*Example Stick Mode2

A general model example. (There is also a different operational model.)

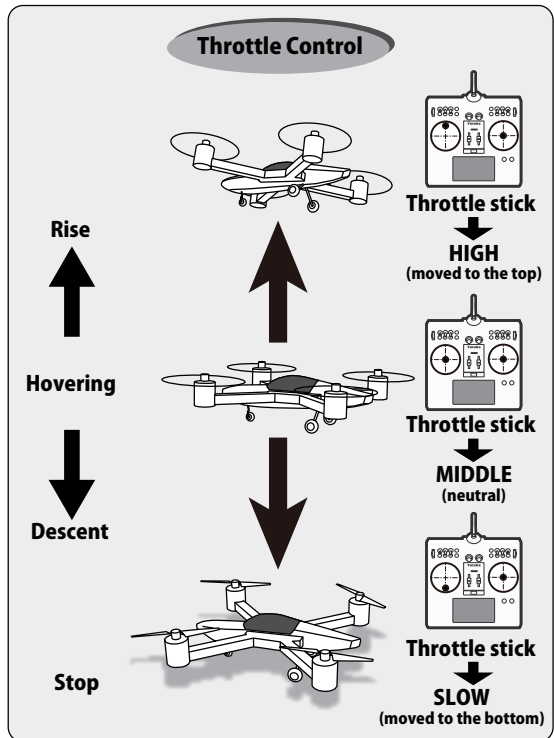
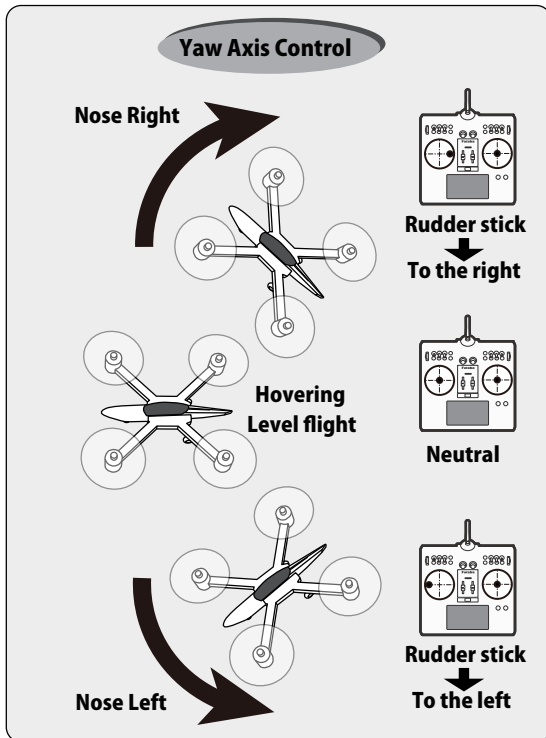
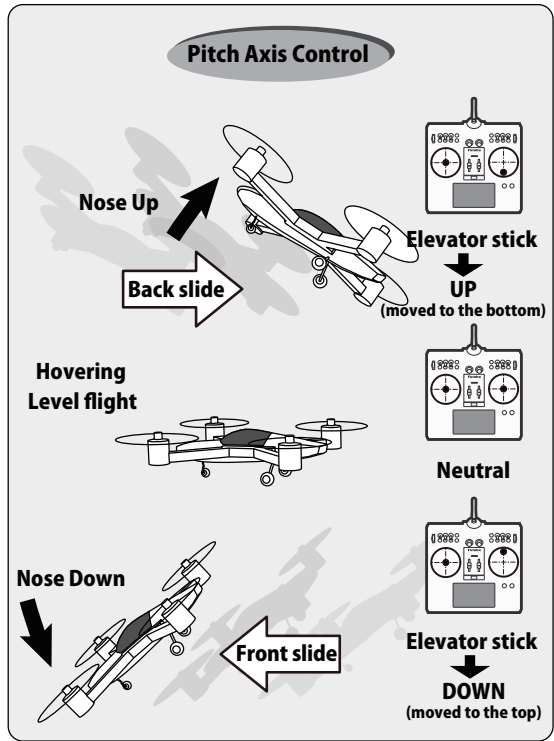
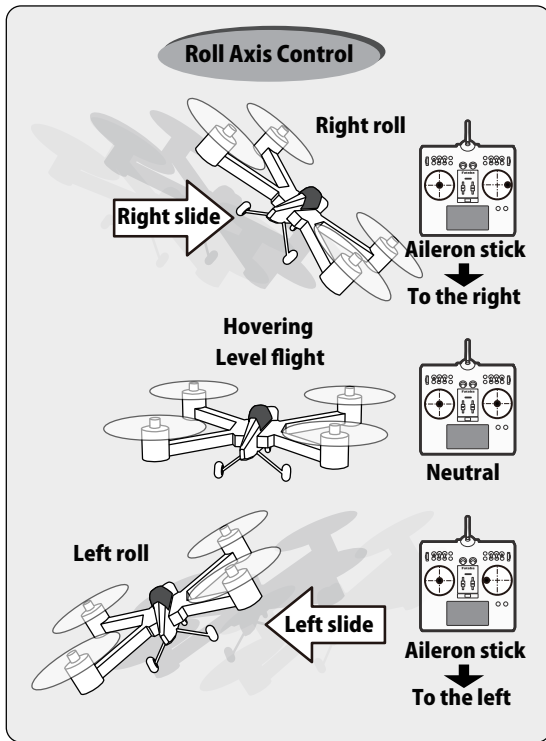

# Stick Adjustment

## Adjustment of the stick lever length

You can adjust the length of stick levers as you like. It is recommended to adjust the length of the sticks in line with your hand size.

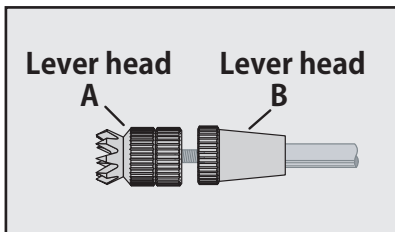

1. Hold the lever head "B" and turn the lever head "A" counter-clockwise. The lock will be released.
2. Turn the lever-head "A" clockwise as you hold the lever-head "B" after placing it as you like.

## Adjustment of stick lever tension

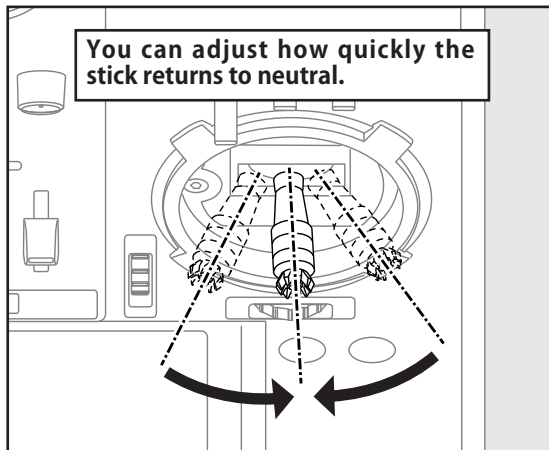

The tension of the self-return type stick lever can be adjusted.

1. First, remove the rear case on the bottom of the transmitter. Next, unplug the battery wire and remove the battery from the transmitter.
2. Use a 1.5mm hexagonal wrench to adjust the spring strength as you prefer by turning the adjusting screw of the stick you want to adjust.

\*Turning the screw clockwise increases the tension.

CAUTION: Loosening the screw too much can interfere with the internal stick operation.

- ◆ For better ergonomics in trays, the set contains 2 stick extensions, which can be used instead of Lever heads A.

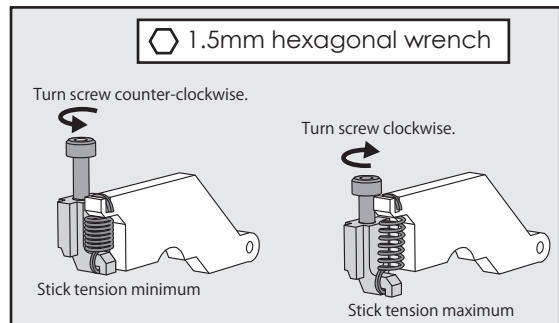
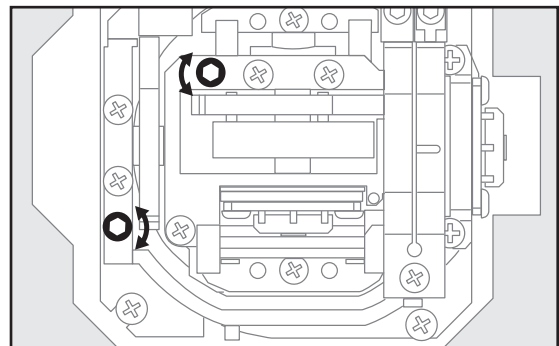
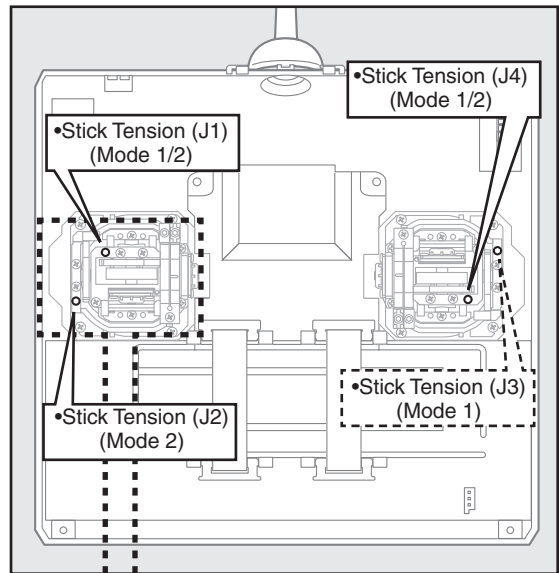

3. At the end of adjustment, re-install the battery and rear case.

## Adjustment of the stick lever angle

You can make fine adjustments to the angle of a stick lever either inwards or outwards from the center stick position.

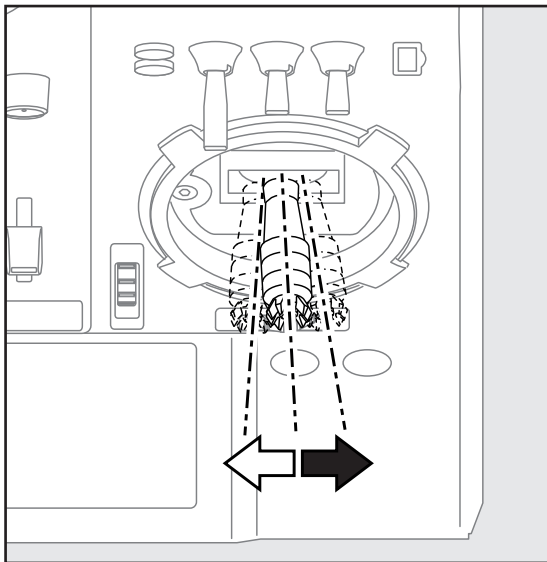
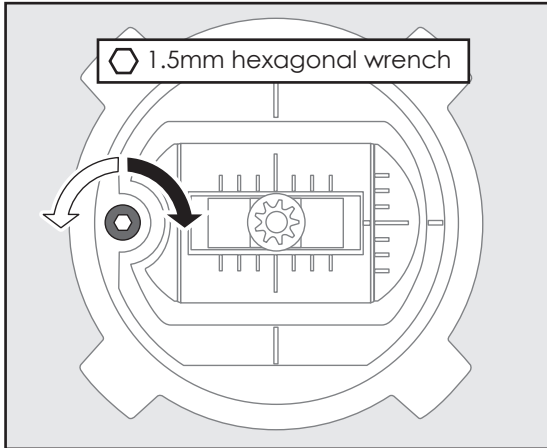

Use the attached 1.5mm hexagonal wrench to turn the screw clockwise to adjust the stick outwards, or counter-clockwise to tilt it inward.

Note: Be careful not to turn the screw too far counterclockwise as it could fall out.

## Through hollow stick lever

When the optional stick switch is connected to the inside accessories connector (SI - SJ), the switch SI - SJ becomes usable.

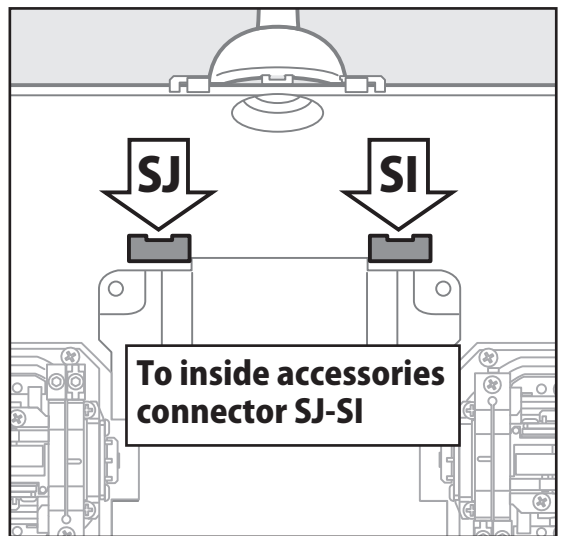
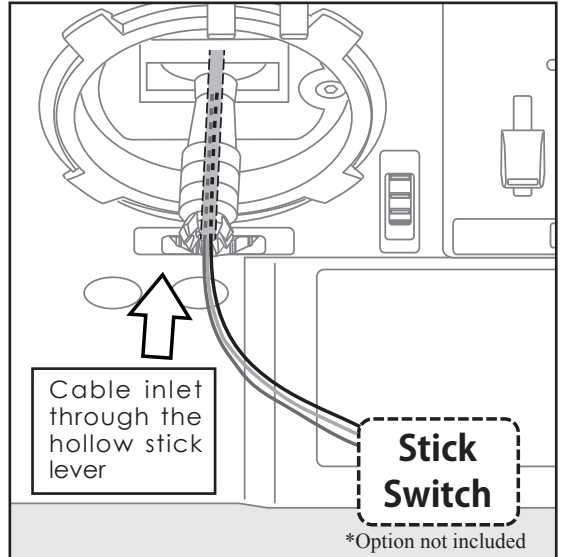

Hardware select of each function

Hardware select		Model1 Condit.1		6.9V	
ON/OFF	--	J1	SA	SG	T1
Set		J2	SB	SH	T2
		J3	SC	SI	T3
		J4	SD	SJ	T4
		RD	SE	RS	T5
		LD	SF	LS	T6

## Adjustment of Throttle Stick (Ratchet System)

You can choose either airplane ratchet system or helicopter-touch.

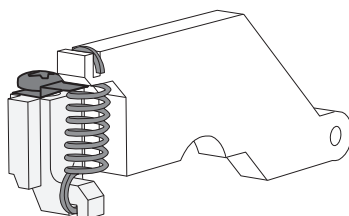
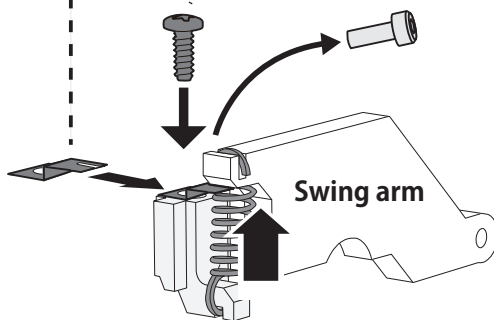
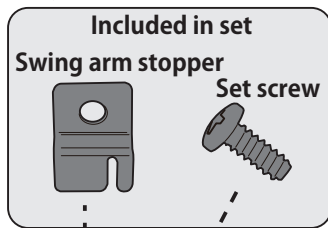
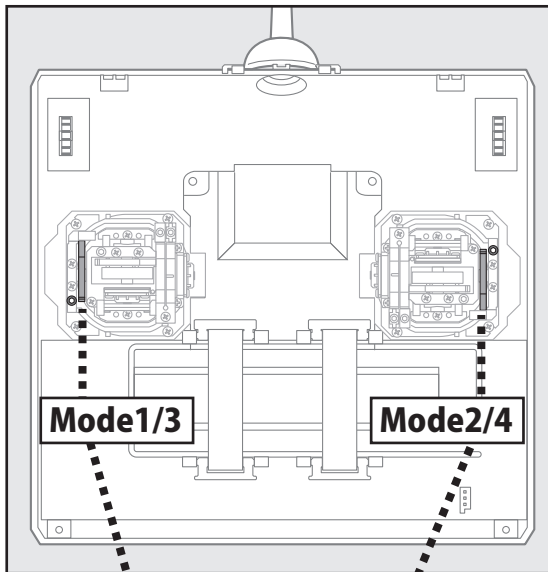

### Modification to ratchet system

When modifying the throttle stick from self-neutral system (factory installation) to ratchet system, use the accessory parts to change the corresponding switch to the mode (Mode 1 or Mode 2) used.

### [Modification]

1. Turn off the power to the transmitter.
2. Open the rear case and remove the battery. (See [Installing/removing the Rear case].)
3. Use the accessory 1.5mm hexagonal wrench to remove the tension adjusting screw.

\*This screw is used only when returning to the self-neutral system. (Save it.)

4. Fasten the accessory swing arm stopper with the set screw as shown in the side diagram. This frees the throttle stick.

\*Lock the stick at the low side or high side by some method so that the stick swing arm does not rise when installing the stopper.

\*Insert the stopper so that the swing arm is not returned by the spring. Align the notch of the stopper to the spring.

Next, adjust it to the tension you prefer.

## Adjustment of Throttle Stick (Ratchet System)

You can choose either airplane ratchet system or helicopter-touch.

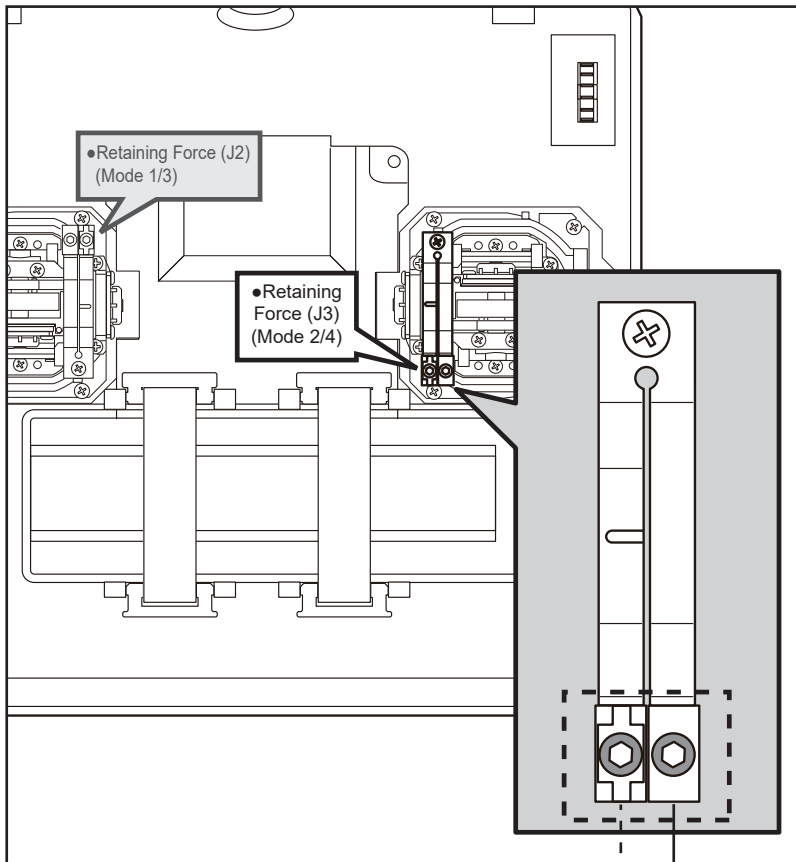

\*This transmitter has two ratchet plates, one for airplane and the other one for helicopter. If you tighten both screws, you won't be able to achieve the adjustment that you need because of the overlap of those two adjustments.

\*If you want to change the setting from airplane to helicopter (or from helicopter to airplane), turn the ratchet screw clockwise until the throttle stick moves freely. Then turn the screw for the helicopter until you get the tension you like.

\*In the Mode 1/3, arrangement of a screw is opposite.

### [Adjustment of tension]

1. First, remove the rear case on the bottom of the transmitter. Next, unplug the battery wire and remove the battery from the transmitter.
2. Use the 1.5mm hexagonal wrench to turn the adjustment screw and set it as you prefer. Turning the screw clockwise increases the tension.

For airplanes: Adjust the screw on the left.

For helicopters: Adjust the screw on the right.

In changing the setting from airplane to helicopter (or heli to airplane);

1. Turn the screw counter-clockwise until the throttle stick moves freely, and turn the screw clockwise to adjust it to the tension you prefer.

### Airplane

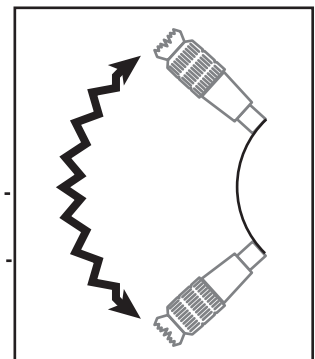

### Helicopter

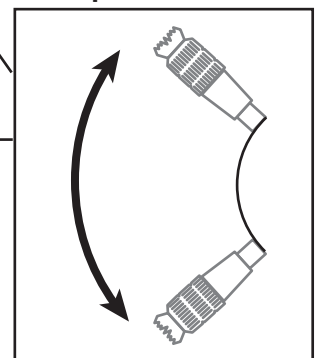



## Connector/Plug

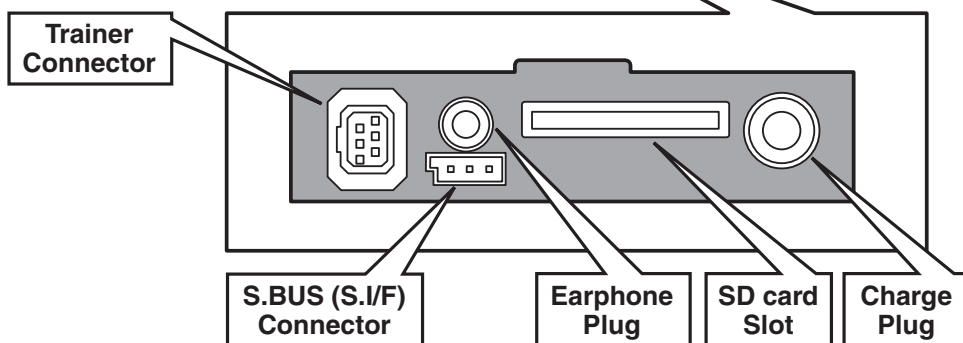
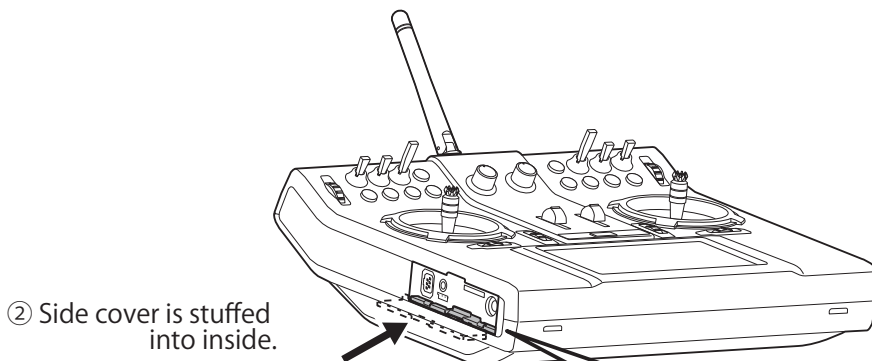
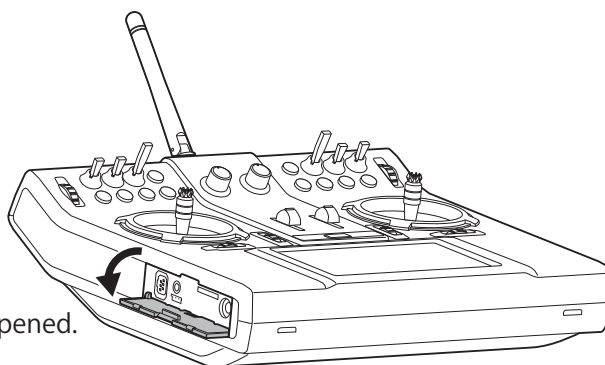

### **Trainer connector**

When you use the trainer function, connect the optional trainer cable between the transmitters for teacher and student.

\*You can set the trainer function on the Trainer Function screen in the System menu.

### **Earphone plug**

Connecting a stereo headphone to this plug, the speech information of telemetry can be heard.

### **⚠ WARNING**

⊘ Do not connect any other chargers except the special charger to this charging connector.

### **S.BUS connector (S.I/F)**

When using an S.BUS servo and telemetry sensor, connect them both here. Voltage supply is included.

### **SD card slot**

The FX-36 transmitter model data can be stored by using any commonly found SD card. When FX-36 transmitter update software is released, the software is updated using an SD card.

### **Connector for battery charger**

For connecting the enclosed charging cable or an optional LiPo charger (only if an optional LiPo battery will be used). Max. charging current 1.5A. Observe the notes on the battery and the battery charger.

## SD Card (secure digital memory card) (not included)

The FX-36 transmitter model data can be stored by using any commonly found SD card. When FX-36 transmitter update software is released, the software is updated using an SD card. The FX-36 is capable of using SD and SDHC cards (SD:32MB-2GB SDHC:4GB-32GB).

### SD card reader/writer

Saving model data and update files (released from Futaba) into the SD card, you can use those files on your FX-36 transmitter. Equipment for reading and writing SD cards is available at most electronics stores.

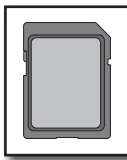

### Stored data

When you have a problem of saving or reading data after a long period of use, please get a new SD card.

\*We are not responsible for, and offer no compensation for, memory card data that fails or is damaged for any reason. Be sure to keep a backup of all important data stored in your SD card.

### Inserting/removing the SD card

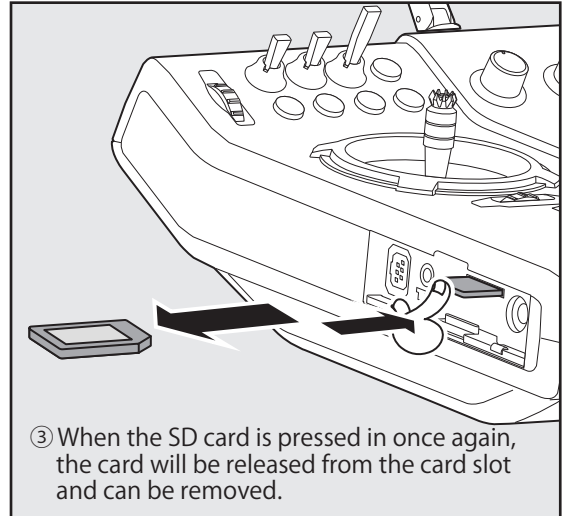
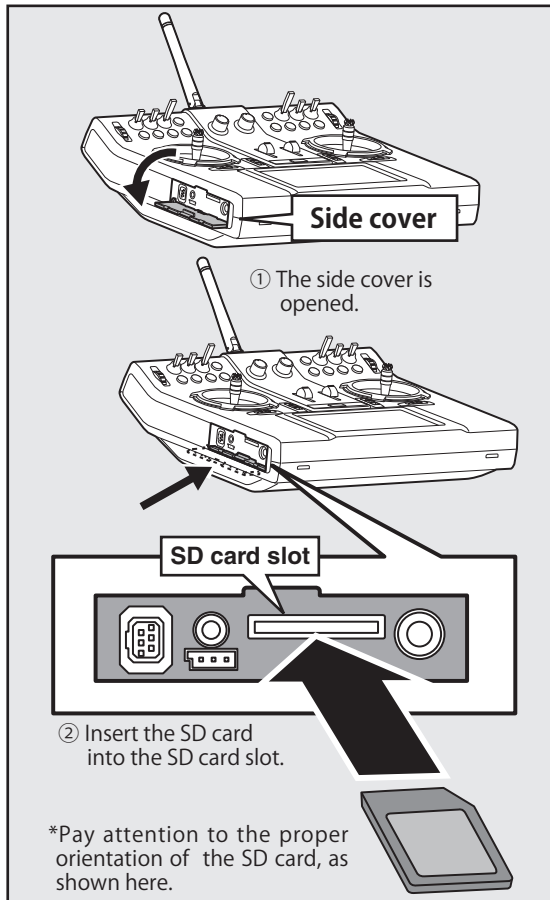

### ⚠ CAUTION

❗ Be sure to turn off the power to the transmitter before inserting or removing the SD card.

⊘ As the SD card is a precision device, do not use excessive force when inserting.

-When an SD card is installed in the FX-36 transmitter, a folder called "Futaba" is created. Folders called "LOG" and "MODEL" are created in this folder. The "MODEL" folder stores the model data and the "LOG" folder stores the telemetry log data.

-The telemetry log data recorded on the SD card can be converted to CSV format by the telemeter log converter released on our home page. When copying or moving a log file, always select both .FLI and .FLD file.



## Receiver nomenclature

Before using the receiver, be sure to read the precautions listed in the following pages.

### Receiver R7008SB

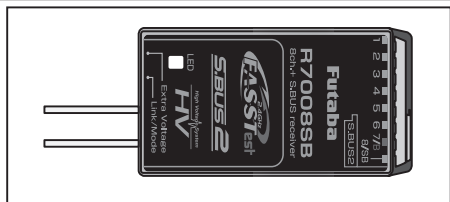

#### Connector

"1 through 6": outputs for the channels 1 through 6

"7/B": outputs of 7 channels and power.

"8/SB": outputs of 8 channels or S.BUS port.

[S.BUS Servo S.BUS Gyro ] →

\*When using 8/SB as S.BUS, you have to set CH MODE of the following page to mode B or mode D.

"S.BUS2": outputs of S.BUS2 port. ←

[S.BUS2 Servo S.BUS2 Gyro Telemetry Sensor ]

\*When using 9 or more channels, use an S.BUS function or use a second R7008SB and link both to your transmitter.

\*CGY750 (S.BUS Gyro) should NOT be connected to the S.BUS2 ports on any receiver.

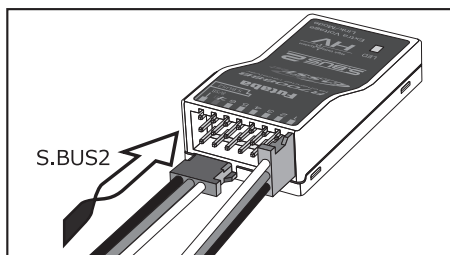

#### Connector insertion

Firmly insert the connector in the direction shown in the figure. Insert the S.BUS2 by turning it 90 degrees.

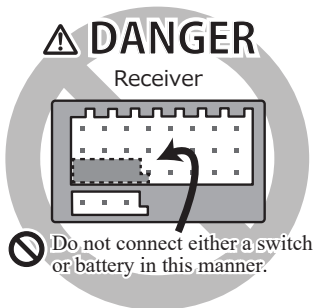

### ⚠ DANGER

⊘ Don't attach a connector as shown in the preceding illustration.

\*It will short-circuit if connected in this way. A short circuit across the battery terminals may cause abnormal heating, fire and burns.

### ⚠ WARNING

S.BUS2 connectors

⊘ Don't connect an S.BUS servo / gyro to S.BUS2 connector.

#### LED Monitor

This monitor is used to check the CH mode of the receiver.

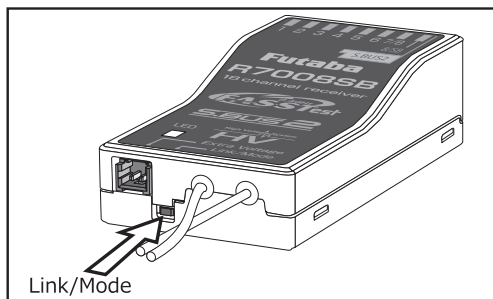

#### Link/Mode Switch

Use the small plastic screw driver that was included with your receiver.

The Link/Mode Switch is also used for the CH mode selection.

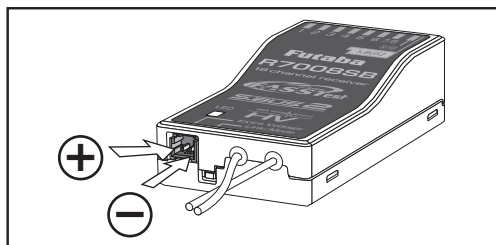

#### Extra Voltage Connector

Use this connector when using a voltage telemetry device to send the battery voltage (DC ~ 70V) from the receiver to the transmitter.

You will need to purchase the optional External Voltage input cable (CA-RVIN-700).

You can then make a cable with an extra connector to the External voltage connector.

## **⚠ DANGER**

### **⊘ Don't touch wiring.**

\* There is a danger of receiving an electric shock.

### **⊘ Do not short-circuit the battery terminals.**

\* A short circuit across the battery terminals may cause abnormal heating, fire and burns.

### **⊘ Please double check your polarity ( + and - ) when hooking up your connectors.**

\* If + and - of wiring are mistaken, it will damage, ignite and explode.

### **⊘ Don't connect to Extra Voltage before turning on a receiver power supply.**

## **R7008SB CH Mode**

The R7008SB receiver is a very versatile unit. It has 8 PWM outputs, S.BUS and S.BUS2 outputs. Additionally the PWM outputs can be changed from channels 1-8 to channels 9-16. If you only desire to use it as an 8 channel receiver (without S.BUS), it can be used without any setting changes.

The FX-36 has the ability to link to two R7008SB receivers. One of them outputting channels 1-8 and the other outputting channels 9-16 gives you 16 PWM channels. Instructions for this configuration and S.BUS operation follow.

[How to change the R7008SB Channel mode.]

1. Press and hold down the Link/Mode button on the R7008SB receiver.
2. Turn the receiver on while holding down the Link/Mode button. When the LED begins to blink green/red the button may be released.
3. The LED should now be blinking red in one of the patterns described by the chart below.
4. Each press of the Mode/Link button advances the receiver to the next mode.
5. When you reach the mode that you wish to operate in, press and hold the Mode/Link button for more than 2 seconds.
6. Once locked into the correct mode the LED will change to a solid color.
7. Please cycle the receiver(s) power off and back on again after changing the Channel Mode.

## **R7008SB CH MODE TABLE**

Receiver connector	Setting channel			
	Mode A 1-8CH	Mode B 1-7CH	Mode C 9-16CH	Mode D 9-15CH
1	1	1	9	9
2	2	2	10	10
3	3	3	11	11
4	4	4	12	12
5	5	5	13	13
6	6	6	14	14
7/B	7	7	15	15
8/SB	8	S.BUS	16	S.BUS
Red LED blink	1 time	2 times	3 times	4 times
	Default			

## Receiver's Antenna Installation

The R7008SB has two antennas. In order to maximize signal reception and promote safe modeling Futaba has adopted a diversity antenna system. This allows the receiver to obtain RF signals on both antennas and fly problem-free.

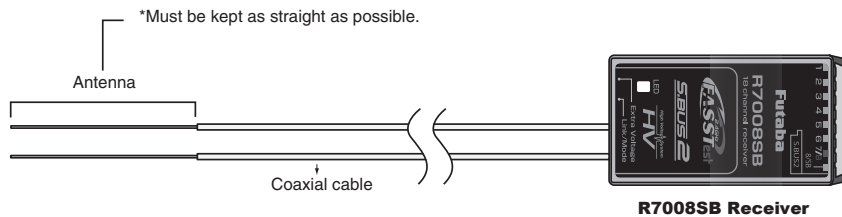

To obtain the best results of the diversity function, please refer to the following instructions:

1. The two antennas must be kept as straight as possible. Otherwise it will reduce the effective range.
2. The two antennas should be placed at 90 degrees to each other.

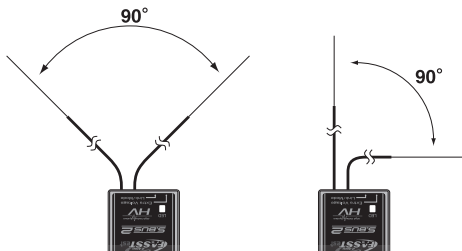

This is not a critical figure, but the most important thing is to keep the antennas away from each other as much as possible.

Larger models can have large metal objects that can weaken the RF signal. In this case the antennas should be placed at both sides of the model. Then the best RF signal condition is obtained at any flying attitude.

3. The antennas must be kept away from conductive materials, such as metal, carbon and fuel tank, by at least half an inch. The coaxial part of the antennas does not need to follow these guidelines, but do not bend it in a tight radius.
4. Keep the antennas away from the motor, ESC, and other noise sources as much as possible.

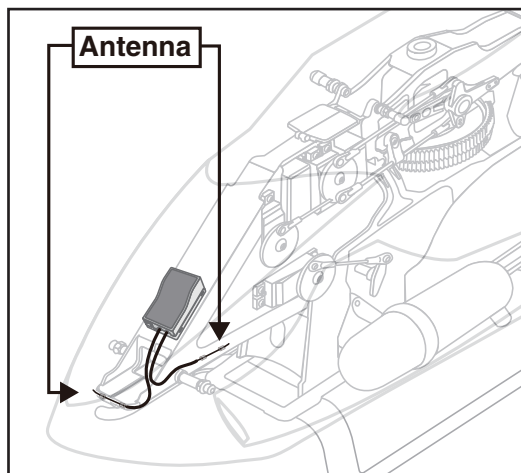
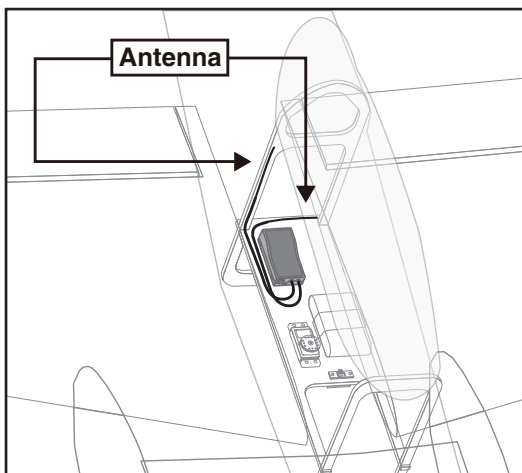

\*The two antennas should be placed at 90 degrees to each other.

\*The illustration demonstrates how the antenna should be placed.

\*Receiver Vibration and Waterproofing: The receiver contains precision electronic parts. Be sure to avoid vibration, shock, and temperature extremes. For protection, wrap the receiver in foam rubber or other vibration-absorbing materials. It is also a good idea to waterproof the receiver by placing it in a plastic bag and securing the open end of the bag with a rubber band before wrapping it with foam rubber. If you accidentally get moisture or fuel inside the receiver, you may experience intermittent operation or a crash. If in doubt, return the receiver to our service center for service.

## Mounting the Servo

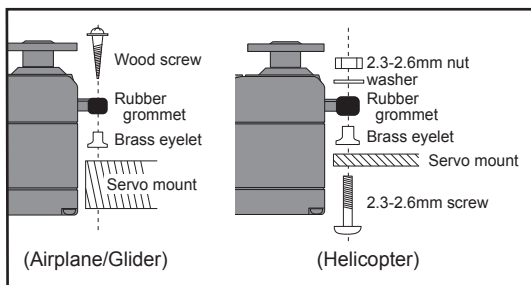

## Servo lead wires

To prevent the servo lead cable from being broken by vibration during flight, provide a little slack in the cable and fasten it at suitable points. Periodically check the cable during daily maintenance.

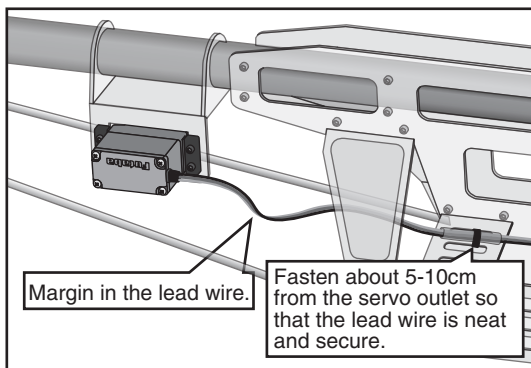

## Mounting the power switch

When mounting a power switch to an airframe, make a rectangular hole that is a little larger than the total stroke of the switch so that you can turn the switch ON/OFF without binding.

Avoid mounting the switch where it can be covered by engine oil and dust. In general, it is recommended to mount the power switch on the side of the fuselage that is opposite the muffler.

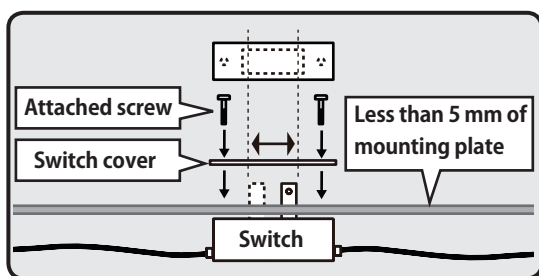

## Safety precautions when you install receiver and servos.

### ⚠ WARNING

#### Connecting connectors

- ❗ Be sure to insert the connector until it stops at the deepest point.

#### How to protect the receiver from vibration and water

- ❗ Wrap the receiver with something soft such as foam rubber to avoid vibration. If there is a chance of getting wet, put the receiver in a waterproof bag or balloon.

#### Receiver's antenna

- ⊘ Never cut the receiver's antenna. Do not bind the receiver's antenna with the cables for servos.
- ❗ Locate the receiver's antenna as far as possible from metals or carbon fiber components such as frames, cables, etc.

\*Cutting or binding the receiver's antenna will reduce the radio reception sensitivity and range, and may cause a crash.

#### Servo throw

- ❗ Adjust your system so that pushrods will not bind or sag when operating the servos to the full extent.

\*If excessive force is continuously applied to a servo, the servo could be damaged due to force on the gear train and/or power consumption causing rapid battery drain.

#### Mounting servos

- ❗ Use a vibration-proof rubber (such as rubber grommet) under a servo when mounting the servo on a servo mount. And be sure that the servo cases do not touch directly to the metal parts such as servo mount.

\*If the servo case contacts the airframe directly, vibration will travel to and possibly damage the servo.

## S.BUS/S.BUS2 Installation

This set uses the S.BUS/S.BUS2 system. The wiring is as simplified and clean mounting as possible, even with models that use a large number of servos. In addition, the wings can be quickly installed to the fuselage without any erroneous wiring by the use of only one simple wire, even when there are a large number of servos used.

- When using S.BUS/S.BUS2, special settings and mixes in your transmitter may be unnecessary.
- The S.BUS/S.BUS2 servos memorize the number of channels themselves. (settable with the FX-36)
- The S.BUS/S.BUS2 system and conventional system (receiver conventional CH used) can be mixed.

S.BUS Glider usage example

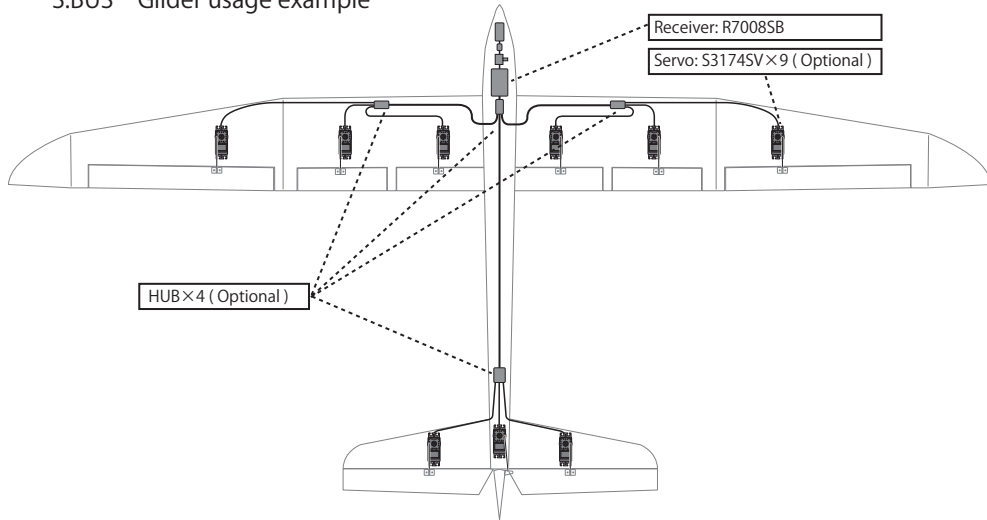

S.BUS Aerobatic plane usage example

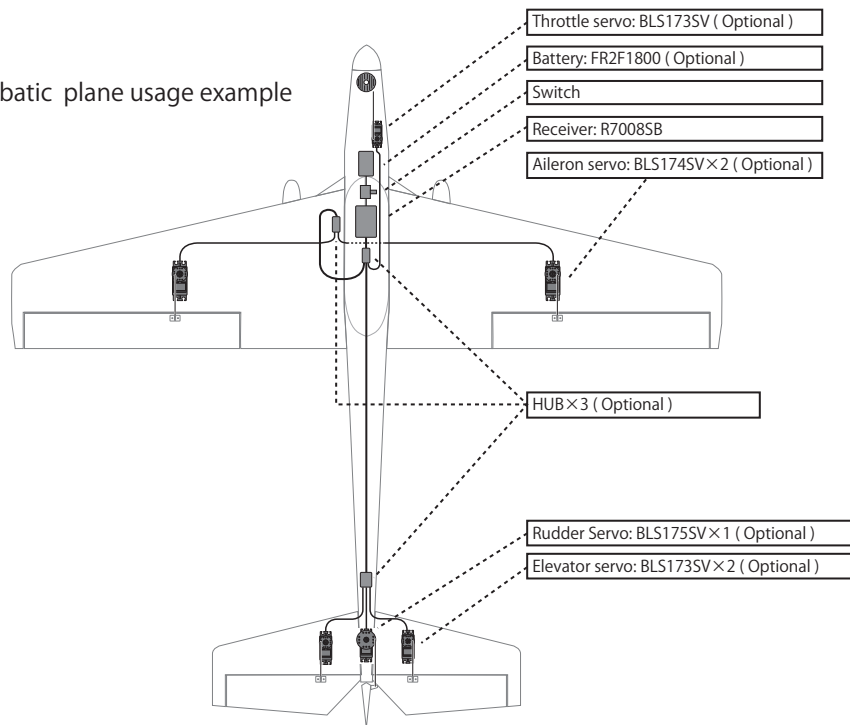



# S.BUS Wiring example

\*When using 8/SB as S.BUS, you must set the receiver to Mode B or Mode D. See R7008SB CH MODE TABLE.

## ● S.BUS Servo

Since the channel number is memorized by the S.BUS itself, any connector can be used. When the SBD-1, SBD-2 (sold separately) is used, ordinary servos can be used with the S.BUS system.  
\*SBD-1 S.BUS Decoders cannot be used by S.BUS2 port.

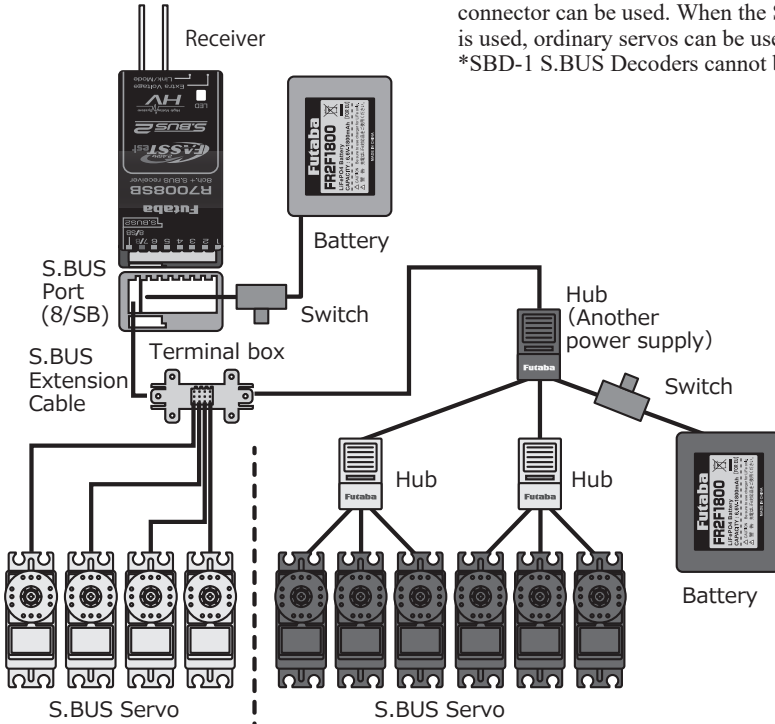

## Optional Parts

### ● 6-Terminal box (TB16PP)

Six connectors can be inserted

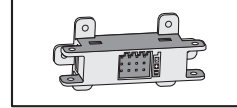

### ● Hub (Another power supply)

Used when using a separate power supply battery.

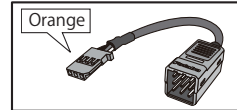

### ● Hub

Three connectors can be inserted.

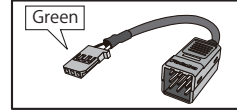

### ● When separate power supply used

When a large number of servos are used or when high current servos are used, the servos can be driven by a separate power supply by using a separate Power Supply 3-way hub with orange connector.

## ⚠ WARNING

### Power supply

❗ Please make sure that you use a battery that can deliver enough capacity for the number and kind of servos used. Alkaline batteries cannot be used.



## S.BUS Gyro CGY750 Connection example

\*When using 8/SB as S.BUS, you must set the receiver to Mode B or Mode D. See R7008SB CH MODE TABLE.

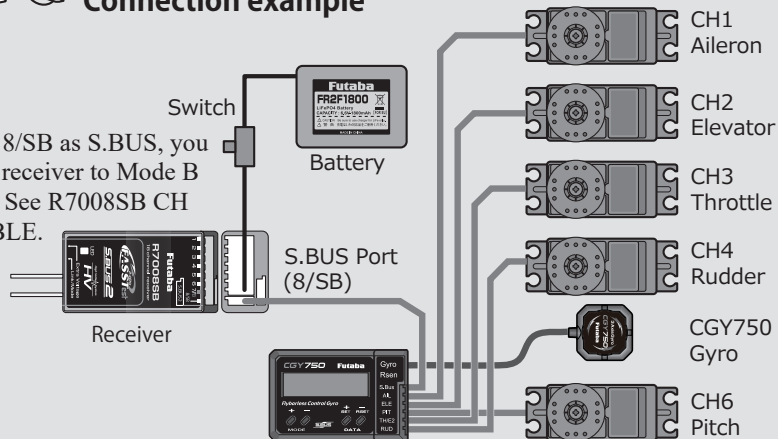



# S.BUS2 System

When using the S.BUS2 port, an impressive array of telemetry sensors may be utilized.

## S.BUS2 TABLE

Receiver port	S.BUS Servo S.BUS Gyro	S.BUS2 Servo S.BUS2 Gyro	Telemetry sensor
S.BUS	○	○	×
<b>S.BUS2</b>	×	○	○

(※) Don't connect S.BUS Servo, S.BUS Gyro to S.BUS2 connector.

**S.BUS servos and gyros and S.BUS2 servos and gyros must be used in the correct receiver ports. Please refer to the instruction manual to make sure you connect to the correct one.**

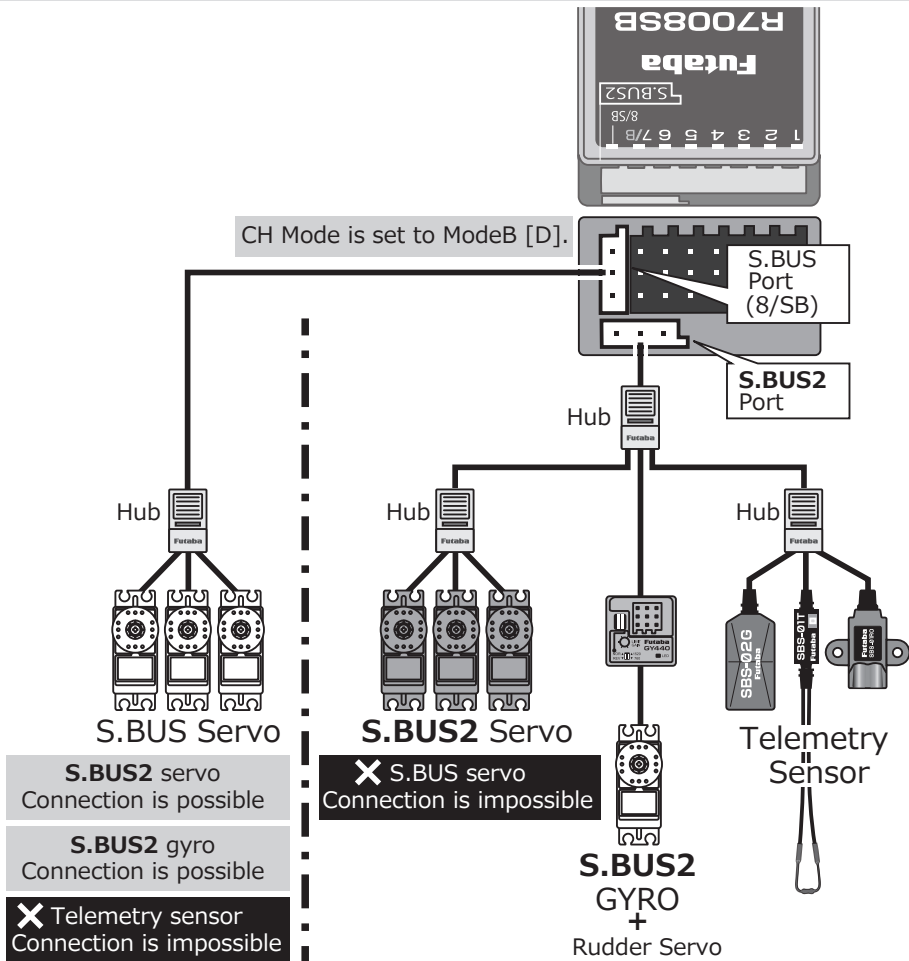

## S.BUS/S.BUS2 device setting

S.BUS/S.BUS2 servos or a telemetry sensor can be connected directly to the FX-36. Channel setting and other data can be entered for the S.BUS/S.BUS2 servos or sensors.

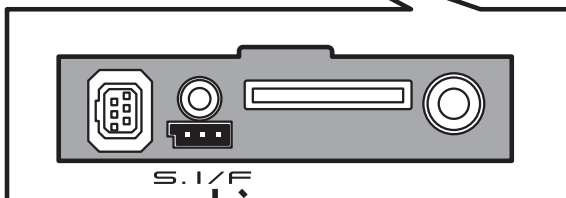
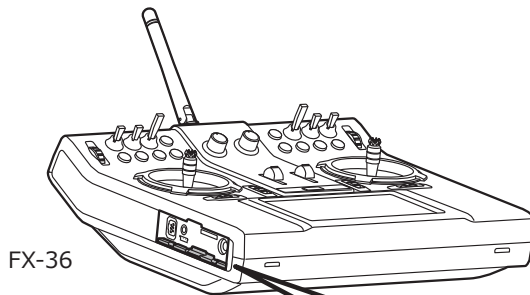

S.BUS/S.BUS2 device  
(S.BUS/S.BUS2 servo)  
(Telemetry sensor)

1. Connect the S.BUS device you want to set with as shown in the figure.
2. Turn on the transmitter power.
3. Call the setup screen.  
Servo: System Menu → S.BUS servo  
Sensor: Linkage Menu → Sensor
4. Perform setting in accordance with each screen.
5. This sets the channel and other data for each S.BUS servo, or telemetry device to be used with the S.BUS device or receiver.

\*It is not necessary to carry out multiple battery connections like a T18MZ/T14SG.

\*When connecting many current-consuming servos, please use an additional power supply hub.

And electric power is supplied to a servo with another power supply.

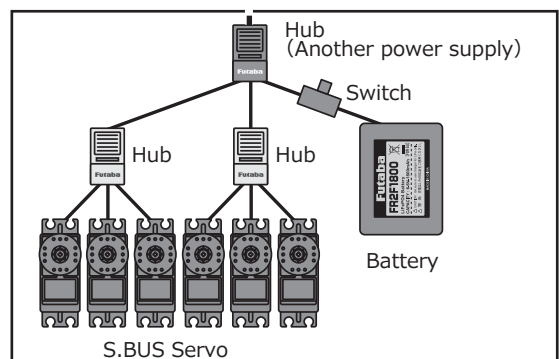

### ● When separate power supply used

When a large number of servos are used or when high current servos are used, the servos can be driven using a separate Power Supply 3-way hub.

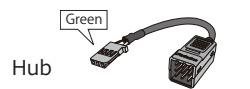

(Another power supply)  
Used when using a separate power supply battery.

### ⚠ WARNING

⊘ Do not disconnect or turn transmitter power OFF while S.BUS servo and telemetry sensor data is being saved.

- S.BUS servo and sensor save data will be lost, resulting in malfunction.

### ⚠ WARNING

⊘ Do not use the S.I/F (S.BUS servo setup) connector with anything other than high-voltage-capable S.BUS servos.

- Transmitter battery voltage (6.6V) is conveyed directly.

Using anything other than high-voltage-capable servos presents the danger that they will break.

# BASIC OPERATION

## Home screen

This is the Home screen and descriptions of its menus. Use your finger to operate the touch screen.

**Battery voltage for receivers**

- In FASSTest/T-FHSS mode, it is displayed. Receiver voltage and Ext voltage display

**Condition name**

- The condition name that is currently used is displayed here.

**Battery Indicator**

- When the battery voltage reaches 5.8V(NiMH), the alarm will beep. Land your aircraft immediately.

**→ (Menu)**

- Model  
Tap the button to call Model Menu screen.

**System mode**

- System(FASSTest18CH etc.) mode is displayed here.

**RF Indicator**

**Date and Time**

**Model Name**

- The model name that is currently used is displayed here.

**User's name**

**Timer1, Timer2**

- Timer is displayed here.  
Tap the time button to start/stop the timer. (When the screen is tapped for 1 second, timer is reset to the initial value.)

**→ (Menu)**

- System
- Linkage
- Model select  
Tap the button to call each Menu screen.

**System timer**

- This shows the accumulated time since the latest reset. (Each model / Total)  
(Hour):(Minute):(Second)

**Rotary trim (T1 to T6)**

- Trim position is displayed here.

### ⚠ WARNING

❗ Be sure to confirm the model name before flying your aircraft.

❗ Check the battery voltage as often as possible and try to charge the battery earlier. If the battery alarm makes a sound, land your aircraft immediately.

\*You can adjust the LCD contrast by the display setting in the system menu.

# Link procedure (FX-36/R7008SB)

Each transmitter has an individually assigned, unique ID code. In order to start operation, the receiver must be linked with the ID code of the transmitter to which it is being paired. Once the link is made, the ID code is stored in the receiver and no further linking is necessary unless the receiver is to be used with another transmitter. When you purchase additional R7008SB receivers, this procedure is necessary; otherwise the receiver will not work.

## Link procedure

1. Place the transmitter and the receiver close to each other within half (0.5m) meter.

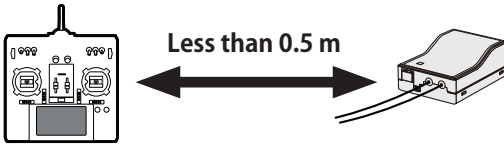

- Turn on the transmitter.
- Select [System type] at the Linkage menu and access the setup screen shown below by tapping the screen.

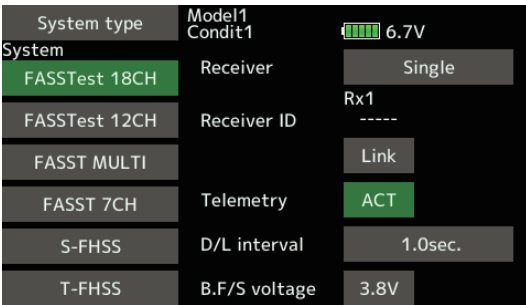

4. When you use two receivers on one model, you must change from [Single] to [Dual].

\*Only two receivers can be used. In "Dual", two setting items come out. Input, respectively.

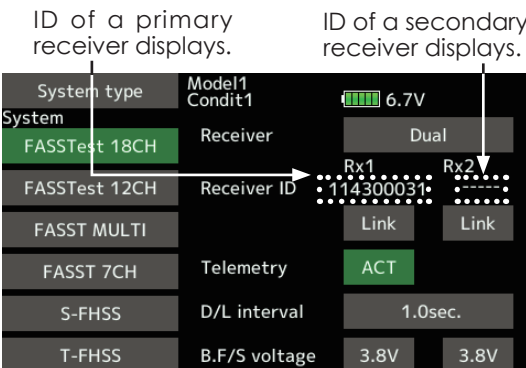

In Dual, a primary receiver (Rx1) is linked first. Next, a secondary (Rx2) receiver is linked.

5. Battery fail-safe voltage can be changed from the initial value of 3.8V here.

\* Only in FASSTest/T-FHSS Mode.

6. [Link] is tapped. The transmitter will emit a chime as it starts the linking process.

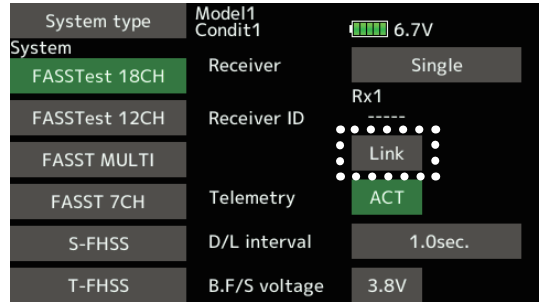

7. When the transmitter starts to chime, power on the receiver. The receiver should link to the transmitter within about 1 second.



### In "Link" Mode



8. If linking fails, an error message is displayed. Bring the transmitter closer to the receiver and repeat the procedure above from Step 2.

9. ACT will be chosen if telemetry is used.  
It is INH when not using it.

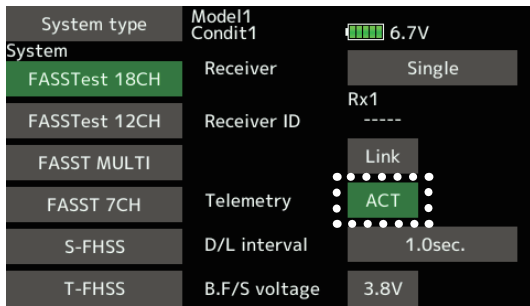

10. When a telemetry function is enabled, the receiving interval (down-link interval) of sensor data can be changed. If a D/L interval is increased, the response of the sensor data display becomes slower, but stick response will improve.

Initial value: 1.0s

Adjustment range: 0.1s~2.0s

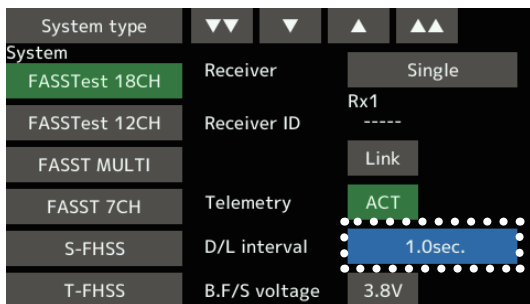

\*If there are many FASSTest (T-FHSS) systems turned on around your receiver, it might not link to your transmitter. In this case, even if the receiver's LED stays solid green, unfortunately the receiver might have established a link to one of other transmitters. This is very dangerous if you do not notice this situation. In order to avoid the problem, we strongly recommend you to double check whether your receiver is really under control by your transmitter by giving the stick input and then checking the servo response.

\*Do not perform the linking operation when the drive motor is connected or the engine is running.

\*When you use two receivers, please be sure to setup a "Rx1" and "Rx2" in the "dual" mode.

\*Telemetry function cannot be used for the 2nd receiver. → FASSTest18CH

\*Telemetry function cannot be used for the dual receiver. → T-FHSS, FASSTest12CH

\*You must link one receiver at a time. If both power supplies to the receivers are switched on simultaneously, data is received incorrectly by the transmitter.

\*You cannot link three receivers.

\*Link is required when a system type is changed.

\*Linking is required whenever a new model is made.

### ⚠ WARNING

❗ After the linking is done, please cycle receiver power and check that the receiver to be linked is really under the control of the transmitter.

⊘ Do not perform the linking procedure with motor's main wire connected or with the engine operating as it may result in serious injury.

### After setting

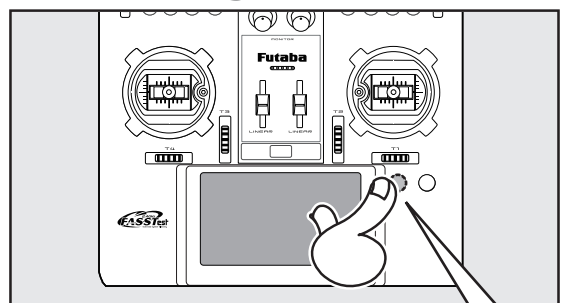

After setting, press a H/E button

## If the receiver's voltage does not display on the transmitter

- ◆ When the receiver has the transmitter's ID in memory, a link is established and normal operation is allowed.
- ◆ When the transmitter has the receiver's ID in memory, a link is established and telemetry functions are usable.

The transmitter stores receiver IDs by model; thus, if it does not have a particular receiver model ID stored in memory or has a different receiver ID stored, telemetry functions will be unusable. However, the device is operable as long as the receiver has the transmitter's ID stored in memory.

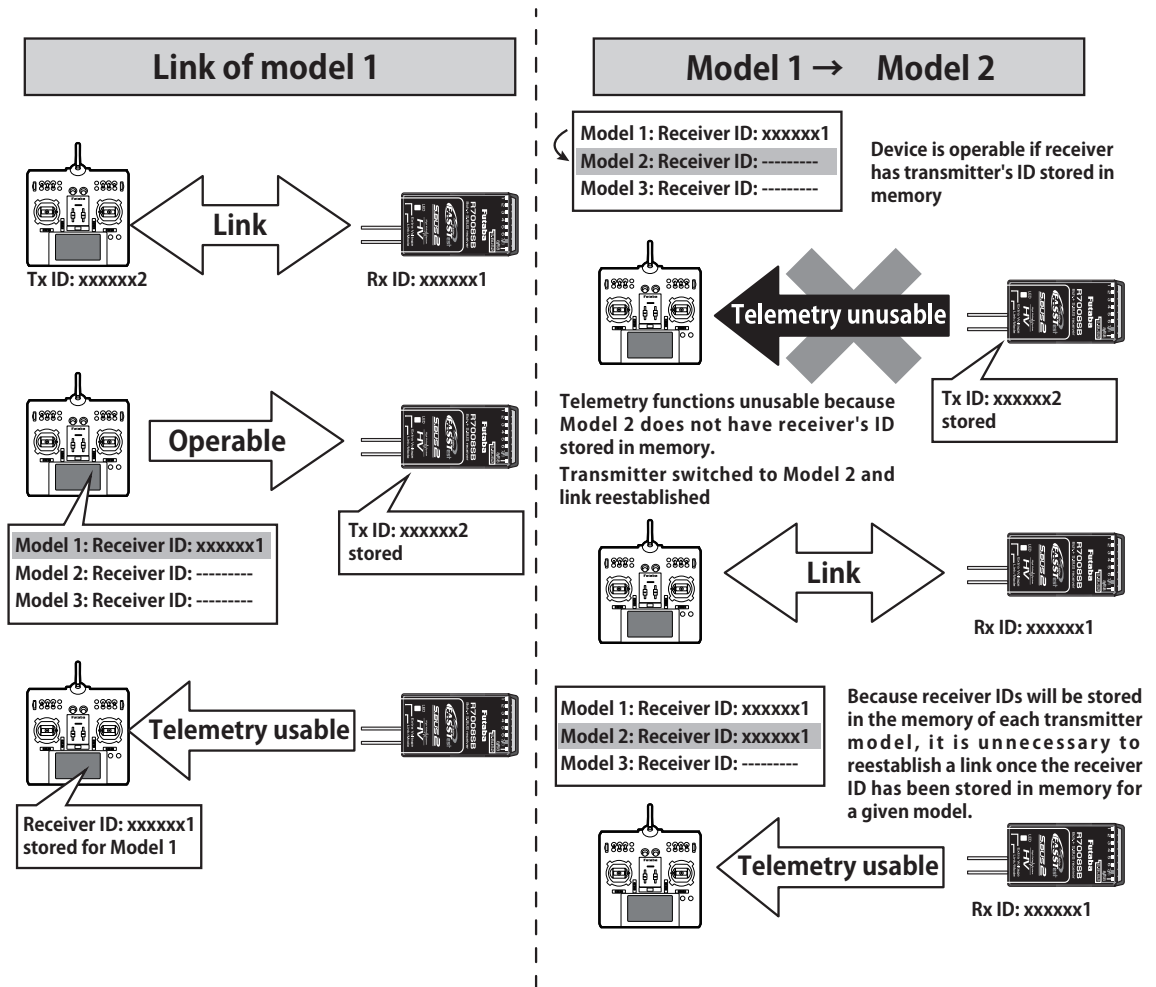

**When setting up a new model, before using it, first establish a link with the receiver that will be used with it.**

# Range Testing Your R/C System

It is extremely important to range check your models prior to each flying session. This enables you to ensure that everything is functioning as it should and to obtain maximum enjoyment from your time flying. The FX-36 transmitter incorporates a system that reduces its power output and allows you to perform such a range check.

## Range check mode

### 1. While pushing "U/M" button.

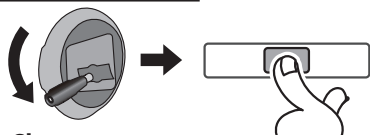
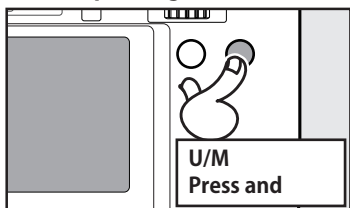

### 2. THR Stick Slow.

### 3. FX-36 Power ON.

### 4. Select "Range check" at the System menu.

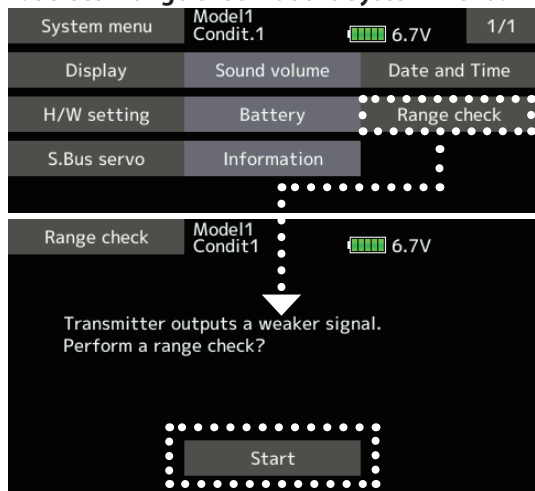

### 5. "Start" tap.



### 6. The H/E button is pressed to end a range check.

During this mode, the RF power output is reduced so the range test can be performed. In addition, when this mode is activated the right LED on the front of the transmitter starts blinking and the transmitter gives users a warning with a beeping sound.

The "Range check mode" continues for 90 seconds and after that the power will return to the normal level. To exit the "Range check mode" before the 90 seconds, press the "H/E" button. NEVER start flying when the "Range check mode" is active.

Should you require additional time to perform a range check, highlight Restart before your time expires and tap the screen one time.

## Range check procedure

1. With the "Range check mode" on, walk away from the model while simultaneously operating the controls. Have an assistant stand by the model to confirm that all controls are completely and correctly operational. You should be able to walk approximately 30-50 paces from the model without losing control.
2. If everything operates correctly, return to the model. Set the transmitter in a safe, yet accessible, location so it will be within reach after starting the engine or motor. Be certain the throttle stick is in the low throttle position, then start the engine or motor. Perform another range check with your assistant holding the aircraft with the engine running at various speeds. If the servos jitter or move inadvertently, there may be a problem. We would strongly suggest you do not fly until the source of the difficulty has been determined. Look for loose servo connections or binding pushrods. Also, be certain that the battery has been fully charged.

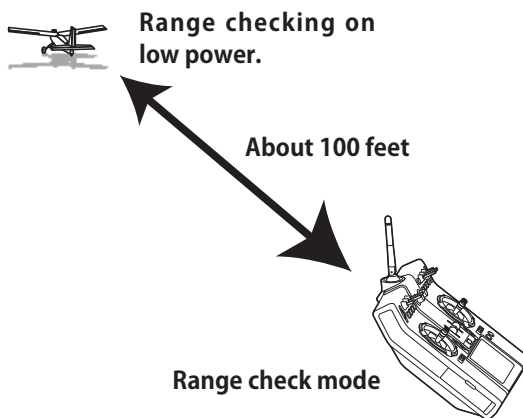

## WARNING

### Do not fly in the range check mode.

\*Since the range of the radio waves is short, if the model is too far from the transmitter, control will be lost and the model will crash.





# MODEL BASIC SETTING PROCEDURE

## Airplane basic setting procedure

### 1. Model addition and call

Initial setting assigns 1 model to the FX-36 transmitter. The Model Select function is used to add models and to select models which are already set.

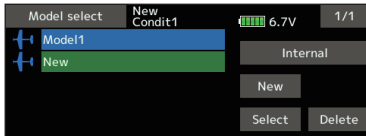

The data for up to 30 models can be saved to the transmitter. Data can also be saved to the optional SD card.

The currently selected model name is displayed at the top of the screen. Before flying and before changing any settings, always confirm the model name.

### 2. Model type selection

Select the model type matched to the aircraft with the Model type select function of the Linkage menu. For an airplane, select the model type from among the 2 types: airplane and glider. After the wing type is selected the tail type select screen is displayed. Select the tail type matched to the aircraft.

There are 13 wing types and 3 tail types for airplane and glider.

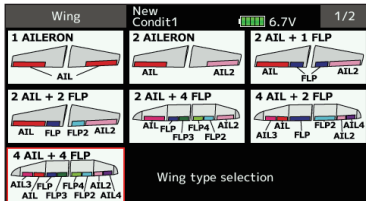

### 3. Fuselage linkage

Connect the ailerons, elevators, throttle, rudder, etc. in accordance with the model's instruction manual. For a description of the connection method, see the "Servos connection by model type".

Note: The channel assignment of the FX-36 is different from that of our existing systems. Note that even for the same "airplane model", when the wing type and tail type are different, the channel assignment may be different. (The channel assigned to each function can be checked at the "Function" of the Linkage menu.)

Ch	Function	New Condit1	Control	6.7V	Trim	1/3
1	Aileron	J1	Gr	Gr	T1	Gr
2	Elevator	J3	Gr	Gr	T3	Gr
3	Throttle	J2	Gr	Gr	T2	Gr
4	Rudder	J4	Gr	Gr	T4	Gr
5	Gear	SG	Gr	Gr	--	Gr
6	Aileron2	--	Gr	Gr	--	Gr

- If the direction of the servo is incorrect, adjust the direction with the Reverse function of the Linkage menu.

Servo reverse	New Condit1	6.7V	1/2
1 Aileron	Normal	7 Aileron2	Normal
2 Elevator	Normal	8 Aileron4	Normal
3 Throttle	Reverse	9 Flap	Normal
4 Rudder	Normal	10 Flap2	Normal
5 Gear	Normal	11 Flap3	Normal
6 Aileron2	Normal	12 Flap4	Normal

- Adjust the neutral position and control surface angle with the linkage, and fine tune them with the Sub trim and End point functions (angle adjustment). To protect the linkage, a limit position can also be set with the End point function. The End point function can adjust the amount of up/down and left/right movement, limit, and servo speed of each channel.

Sub-trim	New Condit1	6.7V	1/2
1 Aileron	+0	7 Aileron2	+0
2 Elevator	+0	8 Aileron4	+0
3 Throttle	+0	9 Flap	+0
4 Rudder	+0	10 Flap2	+0
5 Gear	+0	11 Flap3	+0
6 Aileron2	+0	12 Flap4	+0

End point	New Condit1	Travel	6.7V	Travel	Limit	1/3
1 Aileron	135	100	100	135		
2 Elevator	135	100	100	135		
3 Throttle	135	100	100	135		
4 Rudder	135	100	100	135		
5 Gear	135	100	100	135		

### 4. Throttle cut setting

Throttle cut can be performed with one touch by a switch without changing the throttle trim position.

Set throttle cut with the Throttle cut function of the Linkage menu. After activating the throttle cut function and selecting the switch, adjust the throttle position so that the carburetor becomes fully closed. For safety, the throttle cut function operates the throttle stick in the 1/3 or less (slow side) position.



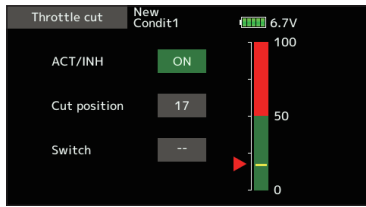

## 5. Idle down setting

The idling speed can be lowered with one touch by a switch without changing the throttle trim position. Perform this setting with the Idle down function of the Linkage menu. After activating the Idle down function and selecting the switch, adjust the idle down speed. For safety, the idle down function acts only when the throttle stick is slow side.

\*While the Throttle cut function is in operation, the Idle down function does not work.

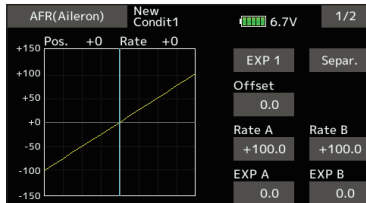

## 6. AFR (D/R)

AFR function is used to adjust the throw and operation curve of the stick, lever, and switch functions for each flight condition. This is normally used after End point has defined the maximum throw directions.

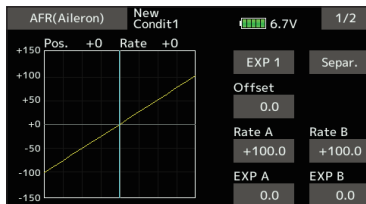

Dual rate	Status	New Condit1	Function	Switch
1 D/R 1	ON	6.7V	Aileron	SD
2 D/R 2	INH		Elevator	SA
3 D/R 3	INH		Rudder	SB
4 D/R 4	INH		Aileron	--
5 D/R 5	INH		Aileron	--
6 D/R 6	INH		Aileron	--

## 7. Airbrake

This function is used when an air brake is necessary when taking off or diving, etc.

The preset elevators and flaps (camber flap, brake flap) offset amount can be activated by a switch.

The offset amount of the aileron, elevator, and flap servos can be adjusted as needed. Also the speed of the aileron, elevator, and flap servos can be adjusted. (In side/Out side) A delay can be set for each condition, and a cut switch which will turn OFF the delay can be chosen. Trim amounts can be fine-tuned by setting a VR. You can also set the auto mode, which will link Airbrake to a stick, switch, or dial. A separate stick switch or dial can also be set as the ON/OFF switch.



## 8. Addition of flight conditions

The Condition select function automatically allocates the Condition 1 for each model. Condition 1 is the default condition and is the only one active when a new model type is defined.

If you want to add flight conditions, please refer to a description of the Condition select function.

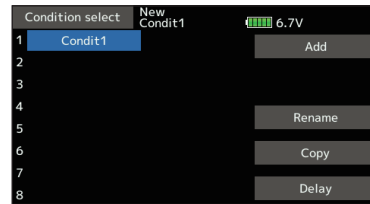

\*The Condition 1 is always on, and remains on until other conditions are activated by switches.

\*When a new condition is added, the model data of the Condition 1 is automatically copied to the new condition.

\*You can set the model data of new condition in the switch ON state. However, if the group mode (Gr) was selected in advance, the same data will be input at all the conditions. Select the single mode (Sngl) and adjust only the condition you want to change. For Group/Single mode switching, refer to the description at the back of this manual.

\*The Condition delay can be programmed for each channel. The Condition delay is used to change the servo throw smoothly when switching conditions.



## Helicopter basic setting procedure

This section outlines examples of use of the helicopter functions of the FX-36. Adjust the actual values, etc. to match the fuselage used.

### 1. Model addition and call

Default setting assigns 1 model to the FX-36. To add new models or to call a model already set, use the Model select function.

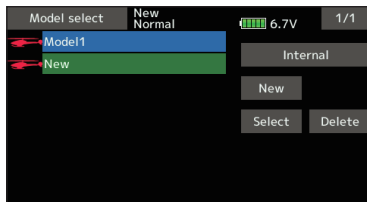

This is convenient when calling a model after registering the model names in advance. (The data of up to 30 models can be saved at the transmitter. Data can also be saved to the optional SD card.)

The currently called model is displayed at the top of the screen. Before flying and before changing any settings, always confirm the model name.

### 2. Model type and swash type selection

If a different model type is already selected, select helicopter with the Model type function of the Linkage menu, and then select the swash type matched to the helicopter.

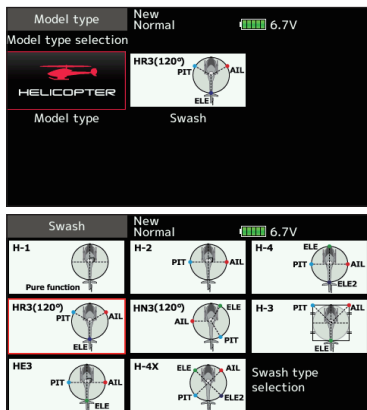

\*The Model type function automatically selects the appropriate output channels, control functions, and mixing functions for the chosen model type. Eight swash types are available for helicopters.

\*For a description of the swash type selection, refer to the Model type function.

### 3. Flight condition addition

The transmitter can install up to eight flight conditions per model.

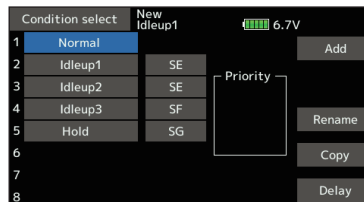

The Condition select function automatically allocates five conditions for helicopter.

(General setting)

- Normal
- Idle up1
- Idle up2
- Idle up3
- Hold

Note: Delete conditions you have not set up and will not use. Otherwise you may accidentally activate them during flight and cause a crash.

\*For a description of the condition deletion, refer to the Condition select function.

The Normal condition is always on, and remains on until other conditions are activated by switches.

The priority is throttle hold/idle up 2/idle up 1/normal. Throttle hold has the highest priority.

Add other conditions, as required.

The Condition delay can be programmed for each channel. The Condition delay is used to change the servo throw smoothly when switching conditions.

#### (General flight condition setting example)

- Normal: (Use initial setting conditions/operate when switch OFF)  
Use from engine starting to hovering.
- Idle up 1: (Operate at SW-E center)  
Use in 540° stall turn, loop, rolling stall turn, and other maneuvers.
- Idle up 2: (Operate at SW-E forward side)  
Use in rolls.
- Throttle hold: (Operate at SW-G forward side)  
Use in auto rotation.



## 4. Fuselage linkage

Connect the throttle rudder, aileron, elevator, pitch, and other servos in accordance with the kit instruction manual. For a description of the connection method, see "Servos connection by model type".

Note: The channel assignment of the FX-36 is different from that of our existing systems. (The channel assigned to each function can be checked at the Function menu of the Linkage menu.)

Function	New	6.7V	1/3
Ch Function	Idleup1	Trim	
1 Aileron	J1	Gr.	T1
2 Elevator	J3	Gr.	T3
3 Throttle	J2	Gr.	T2
4 Rudder	J4	Gr.	T4
5 Gyro	--	Gr.	--
6 Pitch	J2	Gr.	--

- If the direction of operation of the servo is incorrect, use the Reverse function of the Linkage menu. Also use the swash AFR function in other than the H-1 mode.

Servo reverse	New	6.7V	1/2
Ch Function	Idleup1	Ch Function	
1 Aileron	Normal	7 Governor	Normal
2 Elevator	Normal	8 Governor2	Normal
3 Throttle	Reverse	9 Gyro2	Normal
4 Rudder	Normal	10 Gyro3	Normal
5 Gyro	Normal	11 Needle	Normal
6 Pitch	Normal	12 Auxiliary5	Normal

Swash	New	6.7V	1/3
Ch Function	Idleup1	Swash AFR	
Neutral point	Enter	Aileron	+50
		Elevator	+50
		Pitch	+50

- Adjust the direction of operation of the gyro. (Gyro side function)
- Connect the throttle linkage so that the carburetor can fully close at full trim throttle cut.
- Adjust the neutral position at the linkage side and fine tune with the Sub-Trim function and End point function (rudder angle adjustment). To protect the linkage, a limit position can also be set with the End point function.

Sub-trim	New	6.7V	1/2
Ch Function	Condit1	Ch Function	
1 Aileron	+0	7 Aileron2	+0
2 Elevator	+0	8 Aileron4	+0
3 Throttle	+0	9 Flap	+0
4 Rudder	+0	10 Flap2	+0
5 Gear	+0	11 Flap3	+0
6 Aileron2	+0	12 Flap4	+0

End point	New	6.7V	1/3
Ch Function	Condit1	Travel	Travel
1 Aileron	135	100	100 135
2 Elevator	135	100	100 135
3 Throttle	135	100	100 135
4 Rudder	135	100	100 135
5 Gear	135	100	100 135
6 Aileron2	135	100	100 135

- Swash plate correction (Except H-1 mode)  
\*If any interactions are noticed, for a description of the linkage correction function, please refer to the SWASH function.

## 5. Throttle/Pitch curve setting

This function adjusts the throttle or pitch operation curve in relation to the movement of the throttle stick for each condition.

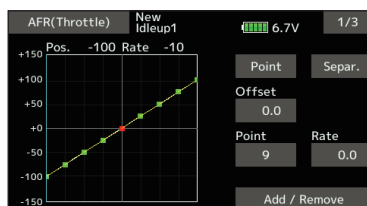

### <Throttle curve setting example>

Call the throttle curve of each condition with the condition select switch.

- Normal curve adjustment  
Normal curve creates a basic throttle curve centered near hovering. This curve is adjusted together with the pitch curve (Normal) so that the engine speed is constant and up/down control is easiest.
- Idle up curve adjustment  
The low side Throttle curve creates a curve matched for aerobatics (loop, roll, 3D, etc.).
- Throttle hold curve adjustment  
The curve is not used when performing auto rotation dives.  
Confirm that the rate of the slowest position (0%) of the stick is 0% (initial setting).

### <Example of pitch curve setting>

Call the pitch curve of each condition with the condition select switch.

- Pitch curve (Normal)  
Make the pitch at hovering approximately +5°~6°. Set the pitch at hovering with the stick position at the 50% point as the standard.  
\*Stability at hovering may be connected to the throttle curve. Adjustment is easy by using the hovering throttle function and hovering pitch function together.
- Pitch curve (Idle up 1)  
The idle up 1 pitch curve function creates a curve



matched to airborne flight.  
Set to  $-7^{\circ}\sim+12^{\circ}$  as standard.

- Pitch curve (Idle up 2)  
The high side pitch setting is less than idle up 1.  
The standard is  $+8^{\circ}$ .
- Pitch curve (Hold)  
At auto rotation, use the maximum pitch at both the high and low sides.  
[Pitch angle setting example]  
Throttle hold:  $-7^{\circ}\sim+12^{\circ}$

## 6. AFR (D/R)

AFR (D/R) function is used to adjust the throw and operation curve of aileron, elevator and rudder for each condition.

\*For throttle and pitch curve settings, refer to the above-mentioned "Throttle/Pitch curve setting"

This is normally used after End point has defined the maximum throw directions.

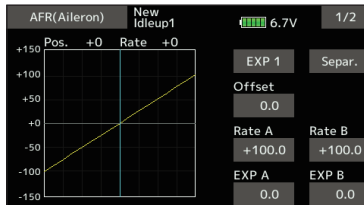

Dual rate	Status	Function	Switch
1 D/R 1	ON	Aileron	SD
2 D/R 2	INH	Elevator	SA
3 D/R 3	INH	Rudder	SB
4 D/R 4	INH	Aileron	--
5 D/R 5	INH	Aileron	--
6 D/R 6	INH	Aileron	--

## 7. Gyro sensitivity and mode switching

The gyro sensitivity and mode switching function is dedicated gyro mixing of the Model menu, and can be set for each condition.

Rate	Gyro(RUD)		Gyro2(AIL)		Gyro3(ELE)	
	AVCS	50	AVCS	50	AVCS	50
Rate 1	ON	50	ON	50	ON	50
Rate 2	AVCS	50	AVCS	50	AVCS	50
	INH	50	INH	50	INH	50
Rate 3	AVCS	50	AVCS	50	AVCS	50
	INH	50	INH	50	INH	50

- Normal condition (hovering): Gyro sensitivity maximum
- Idle up 1/Idle up 2/Throttle hold: Gyro sensitivity minimum
- However, at auto rotation of a tail-driven helicopter, this function may not have any effect at high gyro sensitivity.

## 8. Throttle hold setting

\*If throttle hold is necessary, please refer to the Throttle hold function.

## 9. Throttle cut setting

Throttle cut provides an easy way to stop the engine, by flipping a switch with the throttle stick at idle. The action is not functional at high throttle to avoid accidental dead sticks. The switch's location and direction must be chosen, as it defaults to INH.

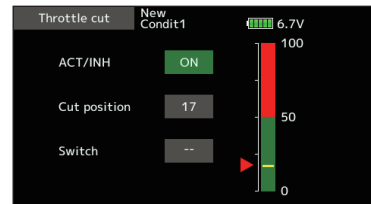

\*With throttle stick at idle, adjust the cut position until the engine consistently shuts off, but throttle linkage is not binding.

## 10. Swash Mix corrects aileron, elevator and pitch interaction

The swash mixing function is used to correct the swash plate in the aileron (Left/Right Cyclic) and elevator (Forward/Aft Cyclic) direction corresponding to each operation of each condition.

Mixing	Status	Switch	Trim
Aileron → Elevator	INH	--	OFF
Elevator → Aileron	INH	--	OFF
Pitch → Aileron	INH	--	OFF
Pitch → Elevator	INH	--	OFF

## 11. Throttle mixing setting

\*If throttle mixing is necessary to compensate for engine slowing caused when the swash plate operates at the same time as ailerons or elevator, please refer to the Throttle mixing function.

## 12. Other special mixings

- Pitch to Needle mixing  
This mixing is used with engines that allow needle control during flight (fuel-air mixture adjustment). A needle curve can be set. The needle servo rise characteristics at throttle stick acceleration/deceleration operation can be adjusted. (Acceleration function)
- Governor mixing  
This mixing is dedicated governor mixing when a governor is used. Up to 3 rates (speeds) can be switched for each condition.



## Servo connection by model type

The FX-36 transmitter channels are automatically assigned for optimal combination according to the type selected with the Model type function of the Linkage menu. The channel assignment (initial setting) for each model type is shown below. Connect the receiver and servos to match the type used.

\*The set channels can be checked at the Function screen of the Linkage menu. The channel assignments can also be changed. For more information, read the description of the Function menu.

### Airplane/glider

#### ●Normal tail and V tail

RX CH	1AIL		2AIL		2AIL+1FLAP		2AIL+2FLAP		2AIL+4FLAP		4AIL+2FLAP		4AIL+4FLAP	
	Airplane	Glider	Airplane	Glider	Airplane	Glider	Airplane	Glider	Airplane	Glider	Airplane	Glider	Airplane	Glider
1	Aileron	Aileron	Aileron	Aileron	Aileron	Aileron	Aileron	Aileron	Aileron	Aileron	Aileron	Aileron	Aileron	Aileron
2	Elevator	Elevator	Elevator	Elevator	Elevator	Elevator	Elevator	Elevator	Elevator	Elevator	Elevator	Elevator	Elevator	Elevator
3	Throttle	Motor	Throttle	Motor	Throttle	Motor	Throttle	Motor	Throttle	Rudder	Throttle	Rudder	Throttle	Rudder
4	Rudder	Rudder	Rudder	Rudder	Rudder	Rudder	Rudder	Rudder	Rudder	Aileron2	Rudder	Aileron2	Rudder	Aileron2
5	Gear	AUX6	Gear	AUX6	Gear	AUX6	Aileron2	Aileron2	Gear	Flap	Gear	Aileron3	Gear	Aileron3
6	Airbrake	Airbrake	Aileron2	Aileron2	Aileron2	Aileron2	Flap	Flap	Aileron2	Flap2	Aileron2	Aileron4	Aileron2	Aileron4
7	AUX5	AUX5	AUX5	AUX5	Flap	Flap	Flap2	Flap2	Flap	Flap3	Aileron3	Flap	Aileron3	Flap
8	AUX4	AUX4	AUX4	AUX4	AUX5	AUX5	Gear	AUX6	Flap2	Flap4	Aileron4	Flap2	Aileron4	Flap2
9	AUX3	AUX3	AUX3	AUX3	AUX4	AUX4	AUX5	AUX5	Flap3	Motor	Flap	Motor	Flap	Flap3
10	AUX2	AUX2	AUX2	AUX2	AUX3	AUX3	AUX4	AUX4	Flap4	AUX6	Flap2	AUX6	Flap2	Flap4
11	AUX1	AUX1	AUX1	AUX1	AUX2	AUX2	AUX3	AUX3	AUX5	AUX5	AUX5	AUX5	Flap3	Motor
12	AUX1	AUX1	AUX1	AUX1	AUX1	AUX1	AUX2	AUX2	AUX4	AUX4	AUX4	AUX4	Flap4	AUX6
13	AUX1	AUX1	AUX1	AUX1	AUX1	AUX1	AUX1	AUX1	AUX3	AUX3	AUX3	AUX3	AUX5	AUX5
14	AUX1	AUX1	AUX1	AUX1	AUX1	AUX1	AUX1	AUX1	AUX2	AUX2	AUX2	AUX2	AUX4	AUX4
15	AUX1	AUX1	AUX1	Butterfly	AUX1	Butterfly	AUX1	Butterfly	AUX1	Butterfly	AUX1	Butterfly	AUX3	Butterfly
16	AUX1	AUX1	Camber	Camber	Camber	Camber	Camber	Camber	Camber	Camber	Camber	Camber	Camber	Camber
DG1	SW	SW	SW	SW	SW	SW	SW	SW	SW	SW	SW	SW	SW	SW
DG2	SW	SW	SW	SW	SW	SW	SW	SW	SW	SW	SW	SW	SW	SW

The output CH of each system  
 FASTest 18CH  
 FASTest 12CH  
 S-FHSS  
 FAST 7CH  
 FAST MULT  
 T-FHSS

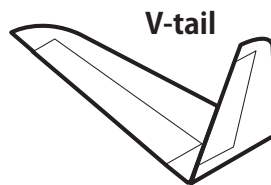
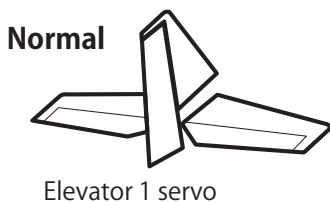



## Airplane/glider

### •Ailevator

RX CH	1AIL		2AIL		2AIL+1FLAP		2AIL+2FLAP		2AIL+4FLAP		4AIL+2FLAP		4AIL+4FLAP	
	Airplane	Glider	Airplane	Glider	Airplane	Glider	Airplane	Glider	Airplane	Glider	Airplane	Glider	Airplane	Glider
1	Aileron	Aileron	Aileron	Aileron	Aileron	Aileron	Aileron	Aileron	Aileron	Aileron	Aileron	Aileron	Aileron	Aileron
2	Elevator	Elevator	Elevator	Elevator	Elevator	Elevator	Elevator	Elevator	Elevator	Elevator	Elevator	Elevator	Elevator	Elevator
3	Throttle	Motor	Throttle	Motor	Throttle	Motor	Throttle	Motor	Throttle	Motor	Throttle	Motor	Throttle	Motor
4	Rudder	Rudder	Rudder	Rudder	Rudder	Rudder	Rudder	Rudder	Rudder	Rudder	Rudder	Rudder	Rudder	Rudder
5	Gear	AUX6	Gear	AUX6	Elevator2	Elevator2	Elevator2	Elevator2	Elevator2	Elevator2	Elevator2	Elevator2	Elevator2	Elevator2
6	Airbrake	Airbrake	Aileron2	Aileron2	Aileron2	Aileron2	Aileron2	Aileron2	Aileron2	Aileron2	Aileron2	Aileron2	Aileron2	Aileron2
7	Elevator2	Elevator2	Elevator2	Elevator2	Flap	Flap	Flap	Flap	Flap	Flap	Aileron3	Aileron3	Aileron3	Aileron3
8	AUX5	AUX5	AUX5	AUX5	Gear	AUX6	Flap2	Flap2	Flap2	Flap2	Aileron4	Aileron4	Aileron4	Aileron4
9	AUX4	AUX4	AUX4	AUX4	AUX5	AUX5	Gear	AUX6	Flap3	Flap3	Flap	Flap	Flap	Flap
10	AUX3	AUX3	AUX3	AUX3	AUX4	AUX4	AUX5	AUX5	Flap4	Flap4	Flap2	Flap2	Flap2	Flap2
11	AUX2	AUX2	AUX2	AUX2	AUX3	AUX3	AUX4	AUX4	Gear	AUX6	Gear	AUX6	Flap3	Flap3
12	AUX1	AUX1	AUX1	AUX1	AUX2	AUX2	AUX3	AUX3	AUX5	AUX5	AUX5	AUX5	Flap4	Flap4
13	AUX1	AUX1	AUX1	AUX1	AUX1	AUX1	AUX2	AUX2	AUX4	AUX4	AUX4	AUX4	Gear	AUX6
14	AUX1	AUX1	AUX1	AUX1	AUX1	AUX1	AUX1	AUX1	AUX3	AUX3	AUX3	AUX3	AUX5	AUX5
15	AUX1	AUX1	AUX1	Butterfly	AUX1	Butterfly	AUX1	Butterfly	AUX2	Butterfly	AUX2	Butterfly	AUX4	Butterfly
16	AUX1	AUX1	Camber	Camber	Camber	Camber	Camber	Camber	Camber	Camber	Camber	Camber	Camber	Camber
DG1	SW	SW	SW	SW	SW	SW	SW	SW	SW	SW	SW	SW	SW	SW
DG2	SW	SW	SW	SW	SW	SW	SW	SW	SW	SW	SW	SW	SW	SW

The output CH of each system  
 FASSTest 18CH  
 FASSTest 12CH  
 S-FHSS  
 FASST 7CH  
 FASST MULT  
 T-FHSS

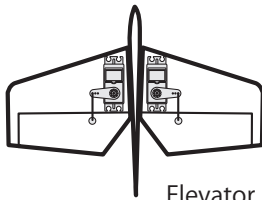

Elevator 2 servo



# Airplane/glider

## •Tailless wing

RX CH	2AIL		2AIL+1FLAP		2AIL+2FLAP		2AIL+4FLAP		4AIL+2FLAP		4AIL+4FLAP	
	Airplane	Glider	Airplane	Glider	Airplane	Glider	Airplane	Glider	Airplane	Glider	Airplane	Glider
1	Aileron	Aileron	Aileron	Aileron	Aileron	Aileron	Aileron	Aileron	Aileron	Aileron	Aileron	Aileron
2	AUX4	AUX4	AUX4	AUX4	AUX4	AUX4	Aileron2	Aileron2	Aileron2	Aileron2	Aileron2	Aileron2
3	Throttle	Motor	Throttle	Motor	Throttle	Motor	Throttle	Motor	Throttle	Motor	Throttle	Motor
4	Rudder	Rudder	Rudder	Rudder	Rudder	Rudder	Rudder	Rudder	Rudder	Rudder	Rudder	Rudder
5	Gear	AUX6	Gear	AUX6	Aileron2	Aileron2	Flap	Flap	Aileron3	Aileron3	Aileron3	Aileron3
6	Aileron2	Aileron2	Aileron2	Aileron2	Flap	Flap	Flap2	Flap2	Aileron4	Aileron4	Aileron4	Aileron4
7	AUX5	AUX5	Flap	Flap	Flap2	Flap2	Flap3	Flap3	Flap	Flap	Flap	Flap
8	AUX3	AUX3	AUX5	AUX5	Gear	AUX6	Flap4	Flap4	Flap2	Flap2	Flap2	Flap2
9	AUX2	AUX2	AUX3	AUX3	AUX5	AUX5	AUX4	AUX4	AUX4	AUX4	Flap3	Flap3
10	AUX1	AUX1	AUX2	AUX2	AUX3	AUX3	Gear	AUX6	Gear	AUX6	Flap4	Flap4
11	AUX1	AUX1	AUX1	AUX1	AUX2	AUX2	AUX5	AUX5	AUX5	AUX5	AUX4	AUX4
12	AUX1	AUX1	AUX1	AUX1	AUX1	AUX1	AUX3	AUX3	AUX3	AUX3	Gear	AUX6
13	AUX1	AUX1	AUX1	AUX1	AUX1	AUX1	AUX2	AUX2	AUX2	AUX2	AUX5	AUX5
14	AUX1	AUX1	AUX1	Butterfly	AUX1	Butterfly	AUX1	Butterfly	AUX1	Butterfly	AUX3	Butterfly
15	Camber	Camber	Camber	Camber	Camber	Camber	Camber	Camber	Camber	Camber	Camber	Camber
16	Elevator	Elevator	Elevator	Elevator	Elevator	Elevator	Elevator	Elevator	Elevator	Elevator	Elevator	Elevator
DG1	SW	SW	SW	SW	SW	SW	SW	SW	SW	SW	SW	SW
DG2	SW	SW	SW	SW	SW	SW	SW	SW	SW	SW	SW	SW

The output CH of each system  
 FASSTest 18CH  
 FASSTest 12CH  
 S-FHSS  
 FASSTest 7CH  
 FASSTest 12CH  
 FASSTest 18CH  
 FASSTest 12CH  
 FASSTest 7CH  
 T-FHSS

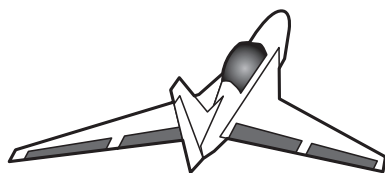

Flying Wing



## Airplane/glider

### •Tailless wing Winglet 2 Rudder

RX CH	2AIL		2AIL+1FLAP		2AIL+2FLAP		2AIL+4FLAP		4AIL+2FLAP		4AIL+4FLAP	
	Airplane	Glider	Airplane	Glider	Airplane	Glider	Airplane	Glider	Airplane	Glider	Airplane	Glider
1	Aileron	Aileron	Aileron	Aileron	Aileron	Aileron	Aileron	Aileron	Aileron	Aileron	Aileron	Aileron
2	Rudder2	Rudder2	Rudder2	Rudder2	Rudder2	Rudder2	Aileron2	Aileron2	Aileron2	Aileron2	Aileron2	Aileron2
3	Throttle	Motor	Throttle	Motor	Throttle	Motor	Throttle	Motor	Throttle	Motor	Throttle	Motor
4	Rudder	Rudder	Rudder	Rudder	Rudder	Rudder	Rudder	Rudder	Rudder	Rudder	Rudder	Rudder
5	Gear	AUX6	Gear	AUX6	Aileron2	Aileron2	Flap	Flap	Aileron3	Aileron3	Aileron3	Aileron3
6	Aileron2	Aileron2	Aileron2	Aileron2	Flap	Flap	Flap2	Flap2	Aileron4	Aileron4	Aileron4	Aileron4
7	AUX5	AUX5	Flap	Flap	Flap2	Flap2	Flap3	Flap3	Flap	Flap	Flap	Flap
8	AUX3	AUX3	AUX5	AUX5	Gear	AUX6	Flap4	Flap4	Flap2	Flap2	Flap2	Flap2
9	AUX2	AUX2	AUX3	AUX3	AUX5	AUX5	Rudder2	Rudder2	Rudder2	Rudder2	Flap3	Flap3
10	AUX1	AUX1	AUX2	AUX2	AUX3	AUX3	Gear	AUX6	Gear	AUX6	Flap4	Flap4
11	AUX1	AUX1	AUX1	AUX1	AUX2	AUX2	AUX5	AUX5	AUX5	AUX5	Rudder2	Rudder2
12	AUX1	AUX1	AUX1	AUX1	AUX1	AUX1	AUX3	AUX3	AUX3	AUX3	Gear	AUX6
13	AUX1	AUX1	AUX1	AUX1	AUX1	AUX1	AUX2	AUX2	AUX2	AUX2	AUX5	AUX5
14	AUX1	AUX1	AUX1	Butterfly	AUX1	Butterfly	AUX1	Butterfly	AUX1	Butterfly	AUX3	Butterfly
15	Camber	Camber	Camber	Camber	Camber	Camber	Camber	Camber	Camber	Camber	Camber	Camber
16	Elevator	Elevator	Elevator	Elevator	Elevator	Elevator	Elevator	Elevator	Elevator	Elevator	Elevator	Elevator
DG1	SW	SW	SW	SW	SW	SW	SW	SW	SW	SW	SW	SW
DG2	SW	SW	SW	SW	SW	SW	SW	SW	SW	SW	SW	SW

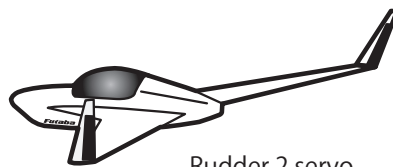

\* Output channels differ by each system of a table. When using a system with few channels, there is a wing type which cannot be used. It cannot be used when there is a function required out of the range of the arrow of a figure.





# Helicopter

● FASSTest 18CH / FASST MULTI / FASST 7CH / S-FHSS

CH	H-4/H-4X Swash	All other
1	Aileron	Aileron
2	Elevator	Elevator
3	Throttle	Throttle
4	Rudder	Rudder
5	Gyro	Gyro
6	Pitch	Pitch
7	Governor	Governor
8	Elevator2	Governor2
9	Gyro2	Gyro2
10	Gyro3	Gyro3
11	Governor2	Needle
12	Needle	AUX5
13	AUX4	
14	AUX3	
15	AUX2	
16	AUX1	
DG1	SW	
DG2	SW	

The output CH of each system  
 FASSTest 18CH    FASST MULTI    T-FHSS  
 S-FHSS  
 FASST 7CH

● FASSTest 12CH

CH	H-4/H-4X Swash	All other
1	Aileron	Aileron
2	Elevator	Elevator
3	Throttle	Throttle
4	Elevator2	Rudder
5	Pitch	Pitch
6	Gyro	Gyro
7	Governor	Governor
8	Rudder	Governor2
9	Gyro2	Gyro2
10	Gyro3	Gyro3
DG1	SW	
DG2	SW	

The output CH of each system  
 FASSTest 12CH



## Multicopter

CH	Multicopter	
1	Aileron	The output CH of each system FASSTest 18CH FASSTest 12CH FASST MULT I-FHSS S-FHSS FASST 7CH
2	Elevator	
3	Throttle	
4	Rudder	
5	Gyro	
6	Gyro2	
7	Gyro3	
8	Camera TILT	
9	Camera PAN	
10	Camera REC	
11	Mode	
12	AUX5	
13	AUX4	
14	AUX3	
15	AUX2	
16	AUX1	
DG1	SW SD	
DG2	SW SA	



## SYSTEM MENU

The System menu sets up functions of the transmitter. This does not set up any model data.

- When the System menu button is tapped, the menu shown below is called up. Tap the function button that you want to enter.

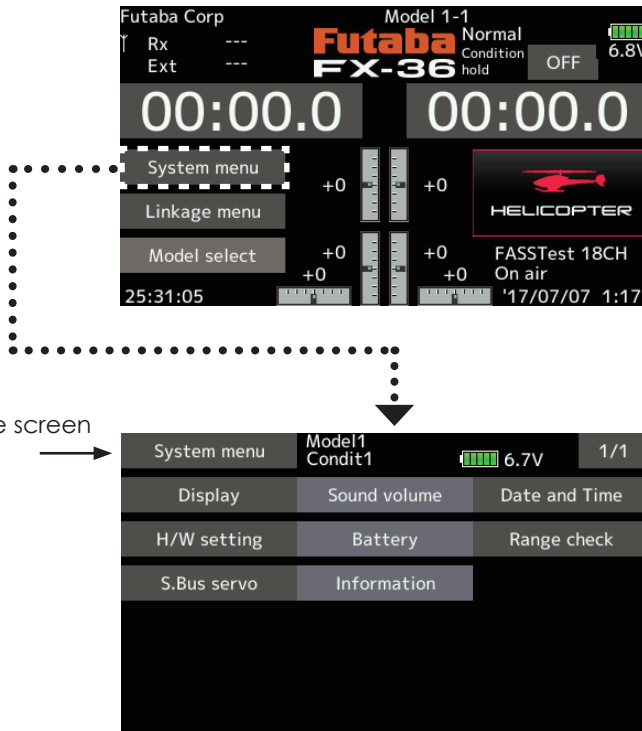

- Return to Home screen

### System menu functions table

[Display]: Display adjustment.

[Sound volume]: Adjust the volume of: Other sound, Warning, Voice

[Date and Time]: Sets the date and time (system clock setting) and resets the system timer.

[H/W setting]: Stick mode selection (Mode 1 - Mode 4 ). J1-J4 sticks correction can be performed.

[Battery]: Battery alarm voltage setting. Auto power off time setting.

**Attention:** When using the 5-cell NiMH battery, the alarm setting is 5NiMH. If you use a 2SLiFe battery, change the setting for the undervoltage warning to 2LiFe, if you use a 2SLiPo battery, change the setting to manual setting 7,0V.

[Battery]: Battery alarm voltage setting. Auto power off time setting.

[Range check]: The output of the transmitter is lowered, for Range checking.

[S.Bus servo]: S.Bus servo setting.

[Information]: Sets the User name, Language, and Unit system. Displays the program version, and SD card information.



# Display

The following LCD screen adjustments:

- Backlighting brightness adjustment
- Backlighting decrease time adjustment
- Touch screen calibration

- Tap the [Display] button in the System menu to call the setup screen shown below.

- Return to System menu



## Backlight max. brightness adjustment

1. Adjust the backlighting brightness with the value input buttons.

\*When the ▲ button is tapped, the backlighting becomes brighter. When the ▼ button is tapped, the backlighting becomes darker.

## Backlight min. brightness adjustment

1. Adjust the backlight decrease brightness with the value input buttons.

\*When the ▲ button is tapped, the backlighting becomes brighter. When the ▼ button is tapped, the backlighting becomes darker.

\*It cannot be made brighter than Backlighting brightness adjustment.

## Backlight decrease time

1. You can set a time period to decrease the LCD backlight. This function counts the period that the Touch Panel has been not operated. This time can be set by ten-second steps. You can also turn off the backlight decrease\* if you like.

\*The backlight consumes a large amount of power. We recommend that you turn off the backlight by setting the backlight power-off time to about one minute.

## Touch calibration

This function adjusts the location of the Touch Panel. Press the "Touch calibration" button. The calibration screen will then pop up. Tap the center of the cross hair cursor on the screen with the soft pen. As soon as the system recognizes the position, the cursor will move on to the next position. Repeat this procedure as long as the cursor moves to next position. You will do this five times. Calibration will be carried out based on the five positions. Disappearance of the cross hair cursor means the calibration has been completed.

\*In ordinary operation, this calibration is not necessary. If you notice the Touch Panel is not functioning correctly after long use, we recommend that you carry out this calibration.



## Sound volume

Sound volume setting

This function can set the volume of "Other sound," "Warning," and "Voice," respectively.

- Tap the [Sound volume] button in the System menu to call the setup screen shown below.

- Return to System menu

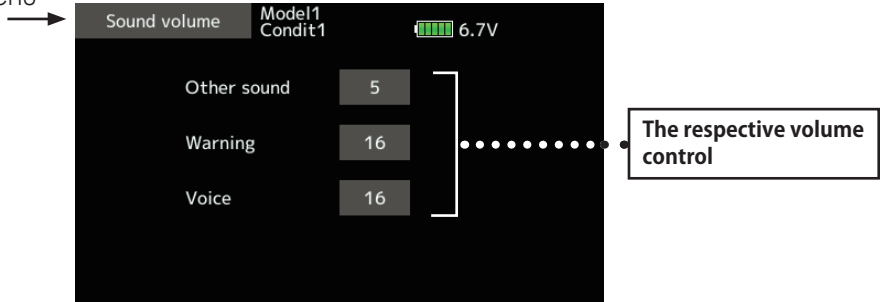

### Sound volume Setting method

1. When the Sound volume box is tapped, the above screen will appear.

2. You can change the sound volume by tapping the "▲▲" "▲" "▼▼" "▼" button of four items.

\*If you tap "▲", the volume will increase. If you tap the "▼", the volume will decrease.

## Date and Time

Date and time setting (system clock setting) and integrating timer resetting

This function adjusts the system clock of the FX-36 transmitter. Perform this setting when you purchase the set and when adjustment is necessary.

The system timer can also be reset.

\*The system timer is displayed on the Home screen.

- Tap the [Date and Time] button in the System menu to call the setup screen shown below.

- Return to System menu

- **Total** : Regardless of a model, additional time in case a power supply is ON is displayed.
- **Model** : The additional time when the power supply was set to ON is displayed for every model.

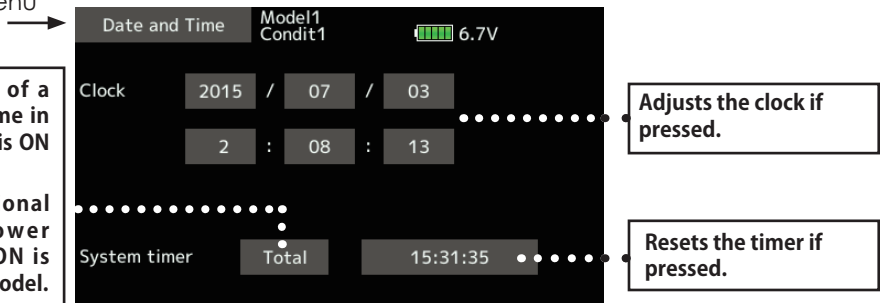

### Date setting

1. Tap the "Year", "Month", or "Day" button and set the date by tapping the "▲▲" "▲" "▼▼" "▼" button.
2. Tap "Time adjust", the timer is renewal.

### Time setting

1. Tap the "Hour" "Minute" or "Second" button, and set the time by tapping the "▲▲" "▲" "▼▼" "▼" button.
2. Tap "Time adjust", the timer is renewal.

### System timer reset

The system timer shows the total time that has elapsed since the last "reset".

1. Tap "Total" or "Model", to reset is chosen.
2. When the [System timer] button is tapped.
3. Tap "Yes" in the next screen, the timer is reset.



# H/W setting

Stick mode selection and J1-J4 sticks calibration

Usually, this H/W setting is unnecessary.

Please perform this calibration only if a change at the center of a stick should arise after prolonged use.

- Tap the [Calibration] button in the System menu to call the setup screen shown below.

- Return to System menu

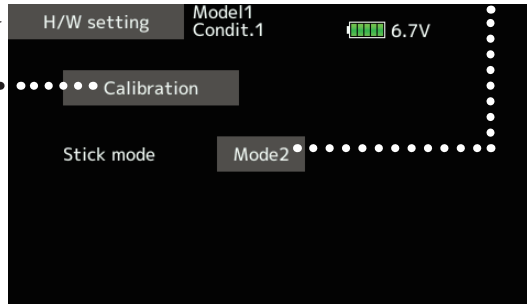

## Stick mode

Mode 1-4 can be chosen. But, it isn't change until data is reset.

To change the mode the stick ratchet must be changed. Request that this be done by Futaba Service. (Charged modification)

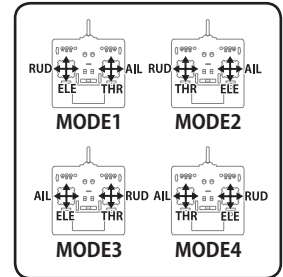

## How to Calibrate

1. Tap the "Calibration" button.



2. Choose the stick to calibrate right and left.
3. The stick is set at neutral and the [Set neutral] button is tapped.

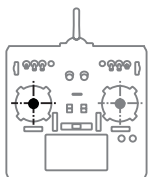
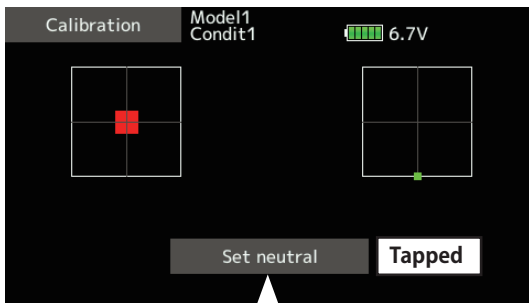

The stick is set at neutral

4. The stick is held at full right and full bottom (diagonal). The [Set endpoint] button is tapped.
5. The stick is held at full left and full top (diagonal). The [Set endpoint] button is tapped.

\*Please do not press the stick too firmly in any direction when doing the calibration.  
\*Check after calibration to make sure that neutral is 0%, the bottom right side is +100%, and the top left side is -100%.

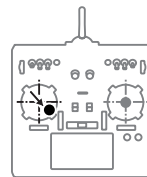
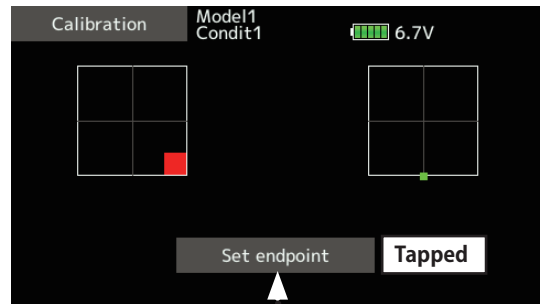

Full right and full bottom

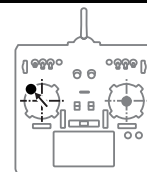
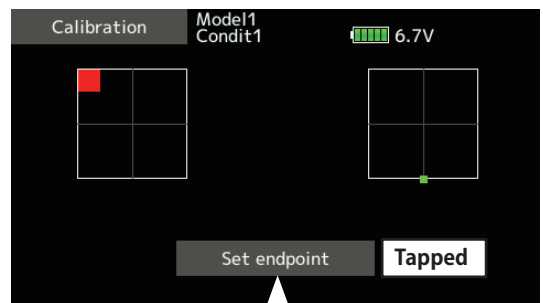

Full left and full top



# Battery

Low battery alarm voltage set

Select the battery alarm voltage according to the battery to be used.

•Return to System menu

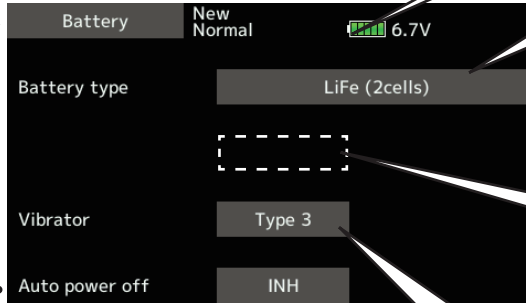

It isn't indicated in case of manual setting.

Battery type change :  
LiFe(2cells) → NiMH(5cells)  
→ Manual setting

When choosing manual setting, the numerical value can be input.

It's dangerous to set it manually in the low voltage.

## Auto power off time setting

This function prevents battery discharging if the transmitter power supply does not erase.

1. Adjust the auto power off time with the value input buttons.

\*When the time the transmitter is inactive reaches the set time, the power is turned off automatically. This time can be set up to 1 hour in 10 minutes increments. The auto power off function can also be deactivated.

\*An audible alarm is sounded from 3 minutes before auto power off. When a stick or switch is operated, the alarm is cleared.

## Vibrator Types

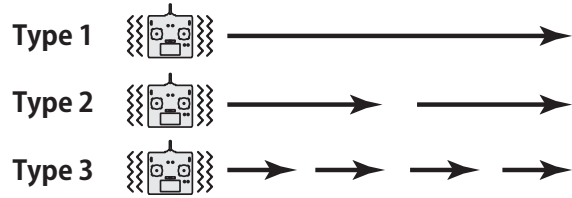

\*When the low battery voltage setting is changed, it is changed for every model in the transmitter. A unique voltage cannot be set for each model. A change in the low battery voltage setting also does not reset other data.

**Attention:** When using the 5-cell NiMH battery, the alarm setting is 5NiMH. If you use a 2SLiFe battery, change the setting for the undervoltage warning to 2LiFe, if you use a 2SLiPo battery, change the setting to manual setting 7,0V.

# Range Check

Before a flight ground range check.

The 'range check mode' reduces the transmission range of the radio waves to allow for a ground range check.

\*The range check mode, when activated, will continue for 90 seconds unless the user exits this mode early. When the progress bar reaches 90 second mark, the RF transmission automatically returns to the normal operating power.

## WARNING

Do not fly in the range check mode.

\*Since the range of the radio waves is short, if the model is too far from the transmitter, control will be lost and the model will crash.





# S.Bus servo

S.BUS servo setting

An S.BUS(2) servo can memorize the channel and various settings you input. Servo setting can be performed on the FX-36 screen by wiring the servo as shown in the figure.

- \* With some S.BUS(2) servos, there are some functions which cannot be used. If a function cannot be used, the display screen will change. (Only the function which can be used by a servo is displayed.)
- \* After reading completion, with connection of the above figure, if a stick is moved, servo operation can be tested.

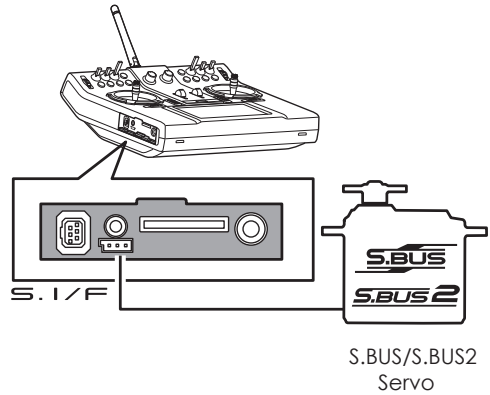

- Call the following setting screen by pressing the [S.Bus Servo] button in the System menu.
- Return to System menu



## Procedure for changing S.BUS servo setting

1. Select [S.Bus servo] of the System menu.
2. Wire the servo as shown in the figure.
3. Press [Read]. The ID and current setting of that servo are displayed.

4. When multiple servos are connected change [INH] at the right side of the ID number on the screen to [ACT] and enter the ID of the servo you want to set.
5. Set each item. (Please see the next page.)
6. Press [Write]. The settings are changed.

## •Servo ID number

If you use multiple S.BUS servos, only the desired servo in the group can be set by entering the ID of that specific servo.

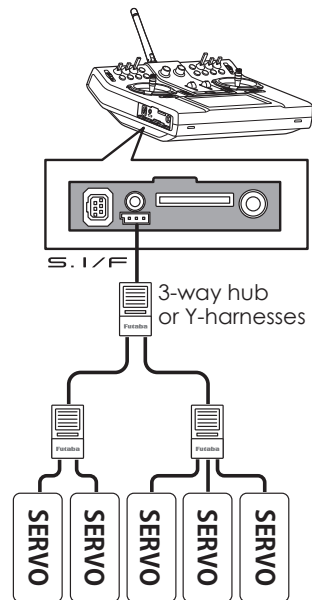
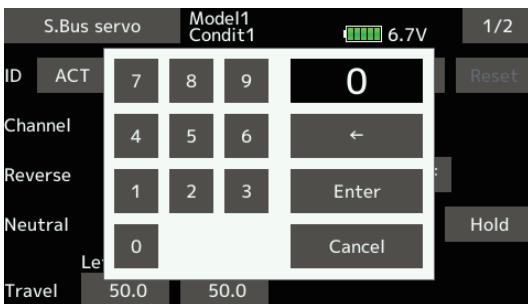





## S.BUS Servo Description of each parameter's function

\*There are functions that can and cannot be performed according to the servo type.

- **ID**

Displays the ID of the servo whose parameters are to be read. It cannot be changed.

- **Channel**

Channel of the S.BUS system assigned to the servo. Always assign a channel before use.

- **Reverse**

The direction in which the servo rotates can be changed.

- **Soft Start**

Restricts operation in the specified direction the instant the power is turned on. By using this setting, the first initial movement when the power is turned on slowly moves the servo to the specified position.

- **Stop Mode**

The state of the servo when the servo input signal is lost can be specified. The "Hold" mode setting holds the servo in its last commanded position even if using AM or FM system.

- **Smoother**

This function changes smoothness of the servo operation relative to stick movement changes. Smooth setting is used for normal flight. Select the "OFF" mode when quick operation is necessary such as 3D.

- **Neutral Offset**

The neutral position can be changed. When the neutral offset is large value, the servo's range of travel is restricted on one side.

- **Speed Control**

Speeds can be matched by specifying the operating speed. The speed of multiple servos can be matched without being affected by motor fluctuations. This is effective for load torques below the maximum torque.

However, note that the maximum speed will not exceed what the servo is capable of even if the servo's operating voltage is increased.

- **Dead band**

The dead band angle at stopping can be specified.

**[Relationship between dead band set value and servo operation]**

Small Value Setting → Dead band angle is small and the servo is immediately operated by a small signal change.

Large Value Setting → Dead band angle is large and the servo does not operate at small signal changes.

**(Note)** If the dead band angle is too small, the servo will operate continuously and the current consumption will increase and the life of the servo will be shortened.

- **Travel Adjust**

The left and right travels centered about the neutral position can be set independently.

- **Boost**

The minimum current applied to the internal motor when starting the servo can be set. Since a small travel does not start the motor, it essentially feels like the dead band was expanded. The motor can be immediately started by adjusting the minimum current which can start the motor.

**[Relationship between boost set value and servo operation]**

Small Value Setting → Motor reacts to a minute current and operation becomes smooth.

Large Value Setting → Initial response improves and output torque increases. However, if the torque is too large, operation will become rough.



### • Boost ON/OFF

OFF : It is the boost ON at the time of low-speed operation.(In the case of usual)

ON : It is always the boost ON.(When quick operation is hope)

### • Damper

The characteristic when the servo is stopped can be set.

When smaller than the standard value, the characteristic becomes an overshoot characteristic. If the value is larger than the standard value, the brake is applied before the stop position.

Especially, when a large load is applied, overshoot, etc. are suppressed by inertia and hunting may occur, depending on the conditions. If hunting (phenomena which cause the servo to oscillate) occurs even though the Dead Band, Stretcher, Boost and other parameters are suitable, adjust this parameter to a value larger than the initial value.

#### [Relationship between damper set value and servo operation]

Small Value Setting → When you want to overshoot. Set so that hunting does not occur.

Large Value Setting → When you want to operate so that braking is not applied. However, it will feel like the servo response has worsened.

**(Note)** If used in the hunting state, not only will the current consumption increase, but the life of the servo will also be shortened.

### • Stretcher

The servo hold characteristic can be set. The torque which attempts to return the servo to the target position when the current servo position has deviated from the target position can be adjusted.

This is used when stopping hunting, etc., but the holding characteristic changes as shown below.

#### [Relationship between stretcher and servo operation]

Small Value Setting → Servo holding force becomes weaker.

Large Value Setting → Servo holding force becomes stronger.

**(Note)** When this parameter is large, the current consumption increases.

### • Buzzer

When a servo is powered up without a transmitter signal, a buzzer sounds.

(When transmitter signal is lost, a buzzer sounds until the servo regains the signal. This is not unusual.)

The transmitter has been turned OFF ahead of a servo power supply → The buzzer sound of about 1.25 Hz continues sounding as servo power supply end failure alarm.

(Do not insert or remove the servo connector while the receiver power is ON. A buzzer may sound by incorrect recognition.)

\*Buzzer sound is generated by vibrating the motor of a servo.

Since current is consumed and a servo generates heat, please do not operate the number more than needed or do not continue sounding a buzzer for a long time.

## WARNING

 While S.BUS servo writes, you aren't supposed to remove a connection of a servo and turn off a power supply of a transmitter.

■ Data of S.BUS servo is damaged and breaks down.

## WARNING

 Do not use the S.I/F (S.BUS servo setup) connector with anything other than high-voltage-capable servos.

■ Transmitter battery voltage is conveyed directly. Using anything other than high-voltage-capable servos presents the danger that they will break.



# Information

The program version and SD card size are displayed. The User name, language and Unit system used by the system can also be changed.

This function registers the FX-36 user name and the language displayed at proportional can be changed.

The Information screen displays the FX-36 system program version information, SD card (memory size, card free size) information.

Telemetry numerical values can be displayed in either metric or SAE (yard-pound) units.

\*If an SD card is not inserted, no memory card information will be displayed.

- Tap the [Information] button at the System menu to call the setup screen shown below.
- Return to System menu

2/3 : WEB Manual QR code  
3/3 : Manufacturer Information

**Telemetry Display Unit**

**[Metric]**  
 Distance --- m (meter)  
 Speed --- km/h (kilometers per hour)  
 Variometer --- m/s (meter per second)  
 Temperature --- °C (centigrade)

**[Yard]**  
 Distance --- yard  
 Altitude --- feet  
 Speed --- mph (mile per hour)  
 Variometer --- fpm (ft per min)  
 Temperature --- °F (fahrenheit)

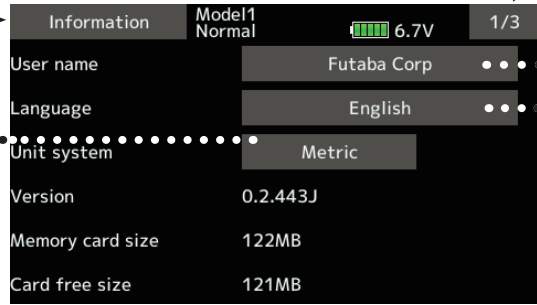

Fix and return to an information screen.

Movement of a cursor of an input box

Back space (Input box)

Next page (Character list 2/4 - 4/4)

An input box is reset

Input box

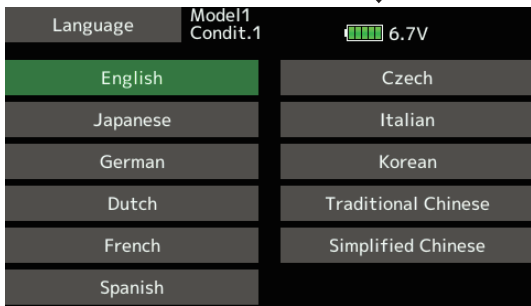
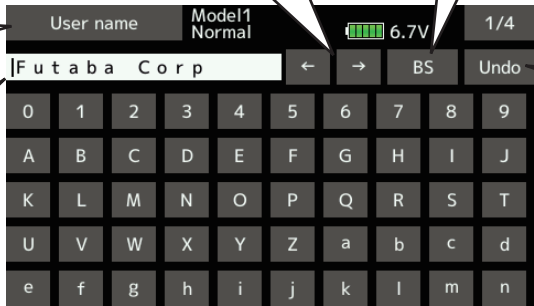

The language displayed at proportional can be changed. The initial setting is English, but different languages can be selected.

## Registration of the user's name

FX-36 transmitter can register user's name.

### How to register user's name

1. Turn on the power of the transmitter.
2. Select "user's name" and then the keyboard will pop up.
3. You can use up to 15 characters as a user's name. Use the keyboard on the screen to enter user's name.



## LINKAGE MENU

The Linkage menu is made up of functions which perform model addition, model type selection, end point setting, and other model basic settings.

- Tap the [Linkage menu] button in the Home screen to call the setup screen shown below.

- Select the function name and return to the Home screen.

Linkage menu	New Condit.1	6.7V	1/2
Servo monitor	Model select	Model type	
Servo reverse	End point	Servo speed	
Sub-trim	Function	Fail safe	
System type	Trim setting	Throttle cut	
Idle down	Stick alarm	Timer	
Function name	Sensor	Telemetry	

### Linkage menu functions table

- [Servo monitor]: Displays the servo test and operation position
- [Model select]: Model addition, call, deletion, copy, model name setting
- [Model type]: Model type, wing type, tail type, swash type, selection
- [Servo reverse]: Servo direction reversal
- [End point]: Servo basic rate adjustment and limit setting
- [Servo speed]: Servo speed setting
- [Sub-trim]: Adjusts the neutral position of each servo
- [Function]: Channel assignment of each function can be changed
- [Fail safe]: Fail safe function and battery fail safe function setting
- [System type]: System mode selection, link of a transmitter and receiver, telemetry mode selection
- [Trim setting]: Control step amount and mode selection of the digital trim
- [Throttle cut]: Stops the engine safely and easily
- [Idle down]: Lowers the idle speed of the engine
- [Swash ring]: Limits the swash plate travel to within a fixed range. (helicopter only)
- [Swash]: Swash AFR and linkage correction function (helicopter only except swash type H-1)
- [Stick alarm]: Can be set so that an audible alarm sounds when the throttle stick reaches the set position.
- [Timer]: Timer setting
- [Function name]: Function name can be changed
- [Sensor]: Various telemetry sensors setting
- [Telemetry]: Displays various data sent from the receiver
- [Tele.setting]: Telemetry data log
- [Trainer]: Starts and sets the trainer system.
- [Warning setting]: Mixing, throttle position warning reset
- [User menu setting]: Original menu making
- [Date reset]: Model memory set data reset (by item)



# Servo monitor

Servo Test & Graph Display / Displays servo positions.

This is used for testing servo movement. “Moving Test” (repetition mode) and “Neutral Test” (fixed position mode) are available.

The “Neutral Test” is good for finding the neutral position of a servo horn.

In order to prevent any potential difficulties, the servo test function will be inoperable, or inaccessible, under certain conditions. Specifically, the Servo Test function is not operational if the Throttle cut is ON in either airplane or helicopter modes; or if the Throttle hold is ON in helicopter mode.

- Select [Servo monitor] at the linkage menu and call the setup screen shown below.

Test mode change : OFF → Neutral → Moving

< or >

● Long press the [U/M] button in the Home screen to call the setup screen shown.

- Return to Home or Linkage menu

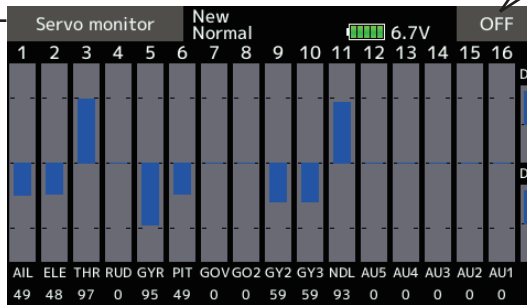

Each channel movement can be checked.

Failure ?

Yes

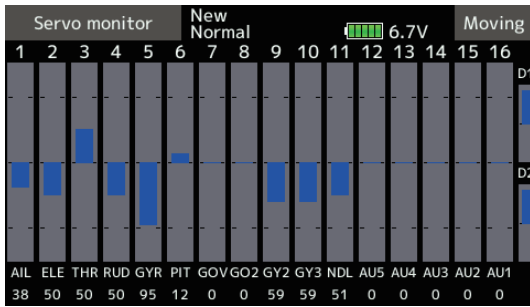

[Moving]: Mode which repeats operation of each servo

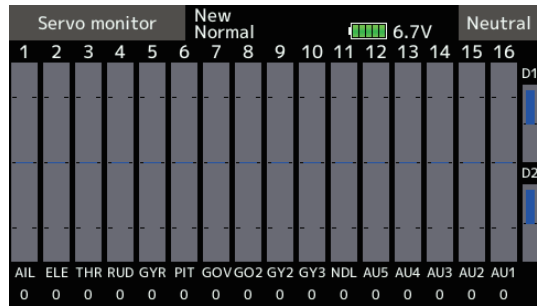

[Neutral]: Mode which locks each servo in the neutral position

Select the [OFF] or pushing the H/E button → Testing is stopped

**⚠ WARNING**

❗ Don't set a servo test mode when the drive motor is connected and the engine has been started.

■ Inadvertent rotation of the motor or acceleration of the engine is extremely dangerous.



# Model select

The Model selection function performs model addition, call, deletion, copy, and model name setting.

This function is used to load the settings of the desired model into the FX-36's memory.

The settings may be selected from either the transmitter's built-in memory or an SD card (32MB-2GB). Remember that up to 30 model memories are available in the transmitter.

The name of the model stored in the transmitter and the SD card may be changed. This can be very useful to tell different models settings apart. Each model name can be as long as 15 characters, and the model name always appears in the display

screen.

The Copy function is used to copy one set of model data into a second memory within the transmitter and the SD card. It may be used for getting a head-start on setting up models with almost the same settings (only differences need to be modified, instead of entering the complete model from scratch). Also, this function may be used to make a backup copy of a model setup before any changes are made. Furthermore, model data of FX-32 can be used.

- Select [Model select] at the linkage menu and call the setup screen shown below.

< or >

- Tap the [Model select] button in the Home screen to call the setup screen shown below.



- When model data on a SD card is used, this icon appears.

- Return to Home or Linkage menu

Current model is green.

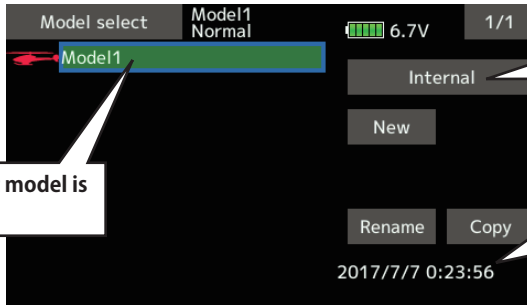

- "Save to" [Internal]: transmitter memory [SD card]: SD card

The date by which the model was made first. In case of a model on a SD card, the file name is indicated. (The file name can't be changed.)

## Model addition

1. Tap the [New] button.

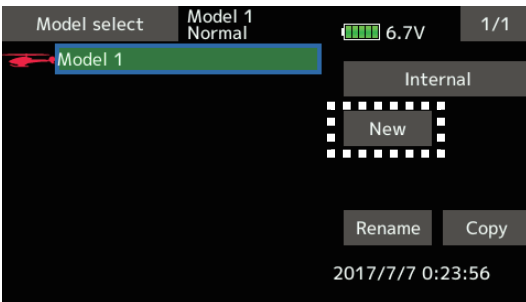

2. Tap [Yes] to add the model. (When you want to cancel model addition, tap [No].)

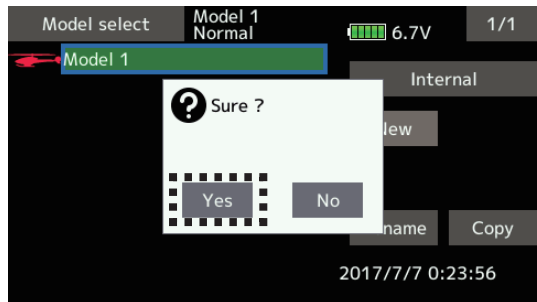

\*The added model is displayed in the model list.

\*When a model is added, a receiver link is required.



## Model call

1. Tap the Internal or SD card. Select the location to which the desired model is to be saved.

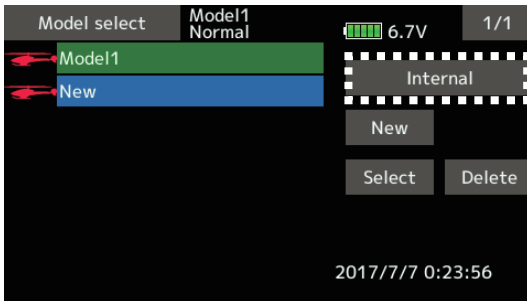

2. Tap the desired model in the model list.
3. Tap the [Select] button.

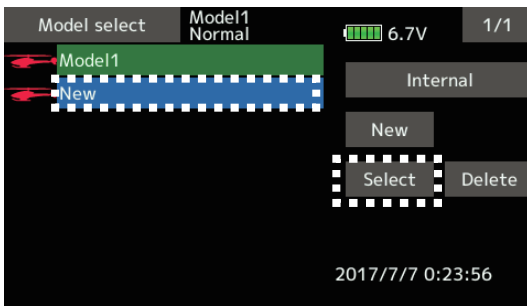

4. Tap [Yes] to call the model. (When you want to cancel model call, press [No].)

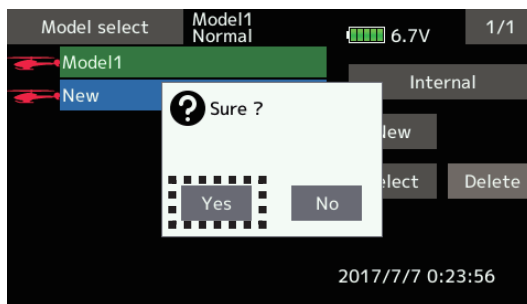

## Model deletion

1. Tap the select model name or the model you want to delete in the model list.

**(The model currently selected cannot be deleted.)**

2. Tap the [Delete] button.

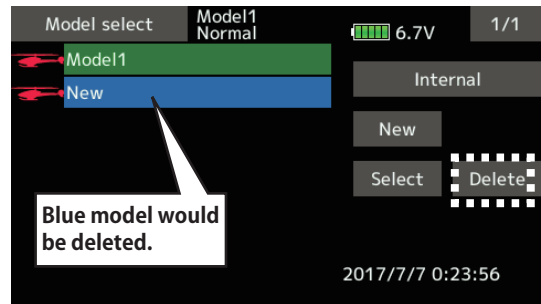

3. Tap [Yes]. (When you want to stop model deletion, tap [No].)

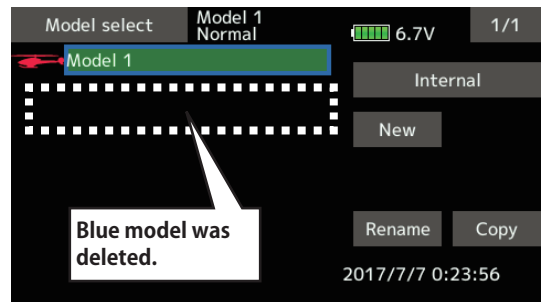
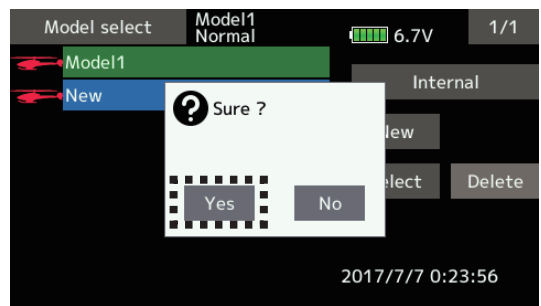



## Model name change

1. The model data chosen at current model can be changed. The current model name, tap.
2. When [Rename] is tapped, a keyboard appears on the screen.

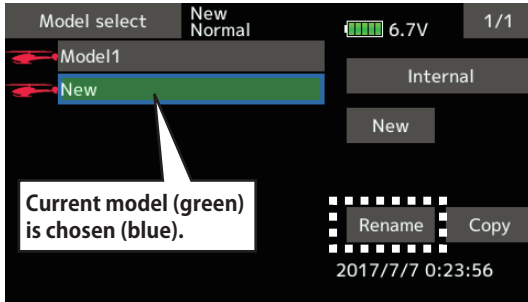

3. Enter the model name from this keyboard.

\*Up to 15 characters can be input at the model name.

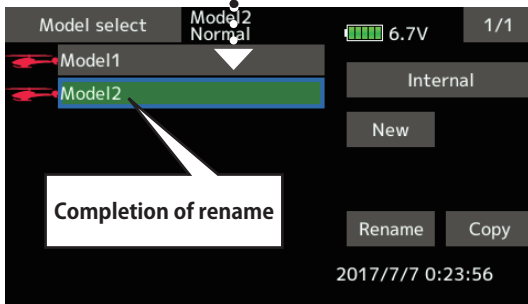
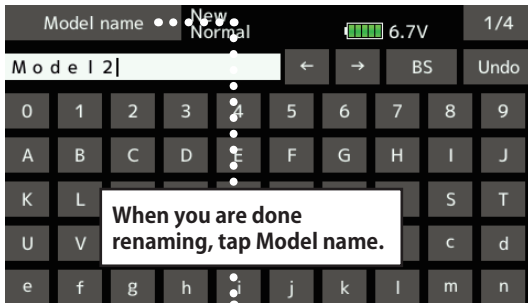

### ⚠ WARNING

- ⊘ Never launch the Model Selection function while the engine is starting or the motor drive wiring is connected.

- Careless spinning of propellers or rotors is extremely dangerous.

### ⚠ WARNING

- ! Carefully check that the aircraft to be used and the model selected match up.

- Using a model which does not match the aircraft runs the risk of the aircraft flying out of control and crashing. Perform a careful operations check prior to flight.

## Model copy

1. The model data chosen at current model can be copied. The current model name, tap.

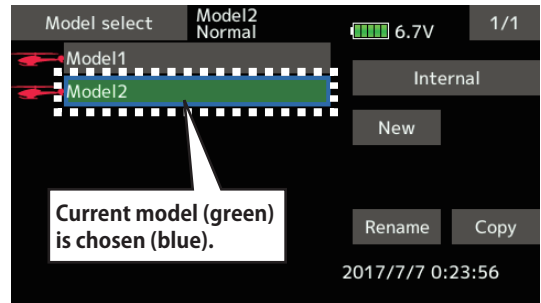

2. Tap the "Copy" button and tap the destination button and select the copy storage destination. (Internal or SD card)

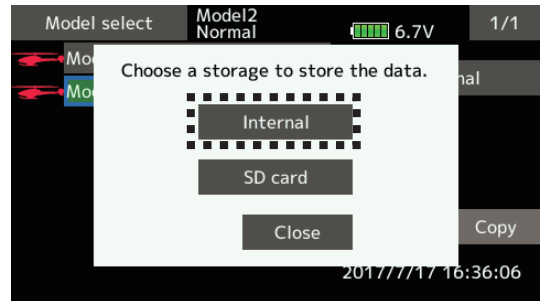

3. When [Internal] or [SD card] is tapped, copying is executed.

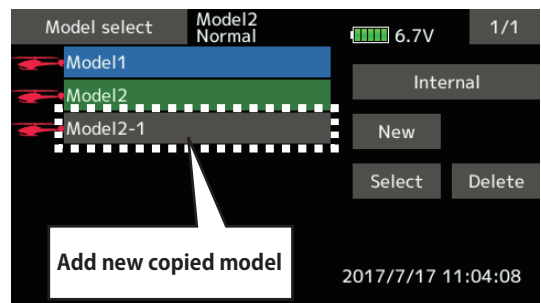

\*If there is no model with the same name in the copy destination, the name of the copied model is saved. If there is a model of the same name, a number is added at the end of the model name and the model is copied. You can change the name later.

\*Indication date : When the model data is copied, the creation date for the current model is recorded.





## Model type

This function selects the model type from among airplane, glider, helicopter, and multicopter.

Seven types of main wings (six types of flying wing) and three types of tail wings are available for airplanes. Eight swash types are available for helicopters. Seven types of main wings and three types of tail wings are available for gliders. Functions and mixing functions necessary for each model type are set in advance at the factory.

Note: The Model Type function automatically selects the appropriate output channels, control functions, and mixing functions for the chosen model type.

When the Model Type Selection command is accessed, all of the data in the active memory is cleared. Be sure that you don't mind losing this data, or back it up to another memory using the copying functions.

(The display screen is an example. The screen depends on the model type.)

- Select [Model type] at the linkage menu and call the setup screen shown below.

- Return to Linkage menu →

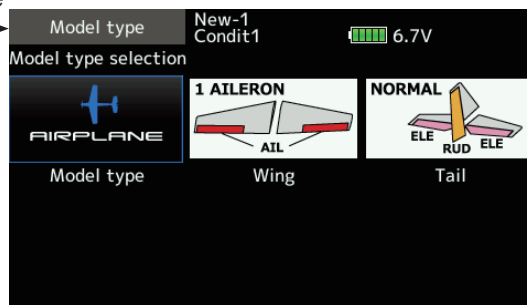

### Model type selection

1. Model type selection [Model icon], tap.
2. Set the Model type, Wing type (Airplane/Glider), or Swash type (Helicopter) by using the appropriate button.
3. Set the type you choose by tapping [Enter] → [Yes] at the confirmation screen. (When you want to cancel model type selection, tap [No].)

- When a data change will occur, the confirmation screen of data initialization menu will be displayed. A push on [yes] will initialize data and allow changes. A push on [no] will stop data changes.

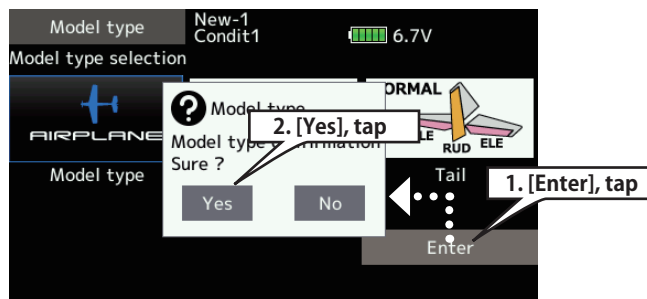



Model type New-1 Condit1 6.7V

Model type selection

AIRPLANE	HELICOPTER	GLIDER
Airplane	Helicopter	Glider
MULTICOPTER		
Multi-copter		

Set the type you choose by tapping.

Airplane/Glider : Choose the wing type and tail.

Helicopter : Choose the swash type.

Model type New-1 Condit1 6.7V

Model type selection

AIRPLANE	1 AILERON AIL	NORMAL ELE RUD ELE
Model type	Wing	Tail

Swash New-1 Condit1 6.7V

H-1 Pure function	H-2 PIT AIL	H-4 ELE PIT AIL ELE2
HR3(120°) PIT AIL ELE	HN3(120°) AIL ELE PIT	H-3 PIT AIL ELE
HE3 PIT AIL ELE	H-4X ELE PIT AIL ELE2	Swash type selection

Wing New-1 Condit1 6.7V 1/2

1 AILERON AIL	2 AILERON AIL AIL2	2 AIL + 1 FLP AIL FLP AIL2
2 AIL + 2 FLP AIL FLP2 AIL2	2 AIL + 4 FLP AIL FLP FLP4 AIL2 FLP3 FLP2	4 AIL + 2 FLP AIL FLP FLP2 AIL4
4 AIL + 4 FLP AIL3/FLP/FLP4/AIL2 AIL FLP3 FLP2 AIL4	Wing type selection	

Tail New-1 Condit1 6.7V

NORMAL ELE RUD ELE	V-TAIL ELE RUD	AILVATOR ELE RUD ELE2
Tail type selection		

Wing New-1 Condit1 6.7V 2/2

Flying Wing 2AIL AIL AIL2	Flying Wing 2AIL+1FLP AIL FLP AIL2
Flying Wing 2AIL+2FLP AIL FLP2 AIL2	Flying Wing 2AIL+4FLP AIL FLP3 FLP4 AIL2
Flying Wing 4AIL+2FLP AIL3 FLP FLP2 AIL4	Flying Wing 4AIL+4FLP AIL3 FLP FLP4 AIL2
Wing type selection	

Tail New-1 Condit1 6.7V

Normal Rudder RUD
Winglet (2RUD) RUD RUD2
Tail type selection



# Servo Reverse

Use to reverse the servo throw direction.

Servo Reverse changes the direction of an individual servo's response to a control stick movement.

For CCPM helicopters, be sure to read the section on Swash AFR before reversing any servos. With CCPM helicopters, always complete your servo reversing prior to any other programming. If you use pre-built Airplane/Glider functions that control multiple servos, it may be confusing to tell whether the servo needs to be reversed or a setting in the function needs to be reversed. See the instructions for each specialized function for further details. Always check servo direction prior to every

flight as an additional precaution to confirm proper model memory, hook ups, and radio function.

**WARNING**

- Before a flight, always check that your model's servo operation, the direction of control surfaces, and switch setup are correct.
- Default setting of the throttle/motor channel is always reverse.

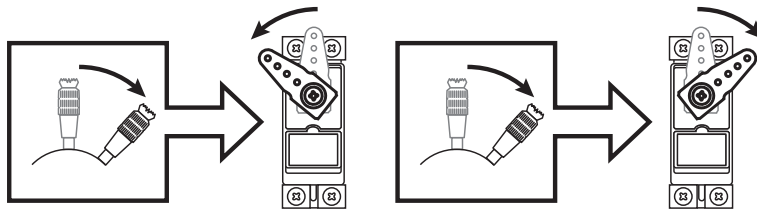

- Tap the [Servo reverse] button in the Linkage menu to call the setup screen shown below.

Return to Linkage menu →

Servo reverse		New-1 Condit1	6.7V	1/2
Ch	Function	Ch	Function	
1	Aileron	7	Auxiliary5	Normal
2	Elevator	8	Auxiliary4	Normal
3	Throttle	9	Auxiliary3	Normal
4	Rudder	10	Auxiliary2	Normal
5	Gear	11	Auxiliary1	Normal
6	Air brake	12	Auxiliary1	Normal

Tap the channel you wish to reverse.

sure ?

Yes No

Tap the "Yes" → Reverse

(The display screen is an example. The screen depends on the model type.)

## Servo reversing procedure

After setting up a new model, be sure to define all special menus. Be sure that all servos are plugged into the proper receiver channels. Now, determine whether you need to reverse any channels by moving each stick and observing the corresponding movement in the model's controls.

- Tap the desired channel's setting button to choose the proper direction for the servo.
  - Tap "Yes" in the next screen.
  - Repeat for each servo needing reversal.
- When done, tap "Servo reverse" to return to the Linkage menu.



# End point

Sets the travel, limit point.

The End point function adjusts the left and right servo throws, generates differential throws, and will correct improper linkage settings.

The travel rate (normal full stick movement at high rates) can be varied from 30% to 140% in each direction on channels 1 to 16. Also, the limit point (how far the servo travels when a mix is involved) where servo throw stops may be varied from 0% to 155%.

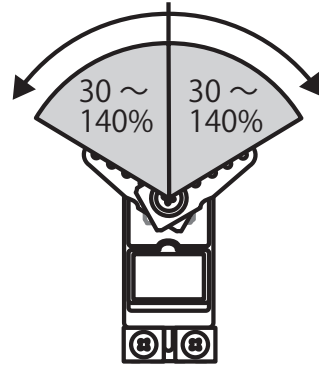

- Tap the [End point] button in the Linkage menu to call the setup screen shown below.
- Return to Linkage menu →

End point		New-1 Condit1		6.7V		1/3	
Ch	Function	Limit	Travel	Travel	Limit		
1	Aileron	135	100	100	135		
2	Elevator	135	100	100	135		
3	Throttle	135	100	100	135		
4	Rudder	135	100	100	135		
5	Gear	135	100	100	135		
6	Air brake	135	100	100	135		

Labels and callouts:

- Travel rate**: Callout pointing to the 'Travel' column.
- Limit point**: Callout pointing to the 'Limit' column.
- Next page Ch7-16**: Callout pointing to the right side of the screen.
- Tap the values you wish to adjust and value input buttons will appear on-screen.**: Callout pointing to the numerical values in the table.
- Left / Top** and **Right / Bottom**: Callouts pointing to a central vertical bar with arrows.
- Indicates the current direction of the stick, etc.**: Callout pointing to the central vertical bar.

(The display screen is an example. The screen depends on the model type.)

## Servo travel adjustment

1. Tap the travel button of the channel you want to set. Value input buttons appear on the screen.
2. Use these buttons to adjust the rate.
  - Initial value: 100%
  - Adjustment range: 30%~140%
3. Repeat the procedure above for each rate.

## Limit point adjustment

1. Tap the limit button of the channel you want to set.
2. Use the value input buttons to adjust the limit point.
  - Initial value: 135%
  - Adjustment range: 0%~155%
3. Repeat this procedure for each limit point.



## Servo speed

Sets the speed of each servo.

The Servo speed setting is used to set the servo delay for each channel, from channel 1 to channel 16. The system uses the programmed speed (delay) to slow down servo position changes. The Servo

speed setting can be varied from 0 to 27 in each channel.

- Tap the [Servo speed] button in the Linkage menu to call the setup screen shown below.

(First) 0 ~ 27 (Slowly)

- Return to Linkage menu

Servo speed		New-1 Condit1	6.7V	1/2
Ch	Function	Ch	Function	
1	Aileron	0	7 Auxiliary5	0
2	Elevator	0	8 Auxiliary4	0
3	Throttle	0	9 Auxiliary3	0
4	Rudder	0	10 Auxiliary2	0
5	Gear	0	11 Auxiliary1	0
6	Air brake	0	12 Auxiliary1	0

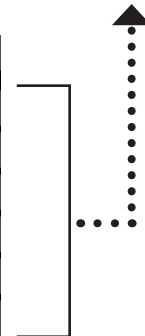

### Servo speed setting

1. Tap the speed button of the channel you want to set.
2. Use the value input buttons to adjust the servo speed.
  - Initial value: 0
  - Adjustment range: 0~27 (steps)

3. Repeat this procedure for each channel.

To close this screen, tap the [Servo speed] button.

## Sub-trim

Setting of neutral position of each servo.

The Sub-Trim function is used to set the servo neutral position, and may be used to make fine adjustments to the control surface after linkages

and pushrods are hooked up. When you begin to set up a model, be sure that the digital trims are set to their center position.

- Tap the [Sub-trim] button in the Linkage menu to call the setup screen shown below.

- Return to Linkage menu

Sub-trim		New-1 Condit1	6.7V	1/2
Ch	Function	Ch	Function	
1	Aileron	+0	7 Auxiliary5	+0
2	Elevator	+0	8 Auxiliary4	+0
3	Throttle	+0	9 Auxiliary3	+0
4	Rudder	+0	10 Auxiliary2	+0
5	Gear	+0	11 Auxiliary1	+0
6	Air brake	+0	12 Auxiliary1	+0

### Sub-trim adjustment

1. Tap the trim display part of the channel you want to adjust.  
Value input buttons appears on the Sub-trim menu screen.

2. Use the value input buttons to adjust the sub trim.
  - Initial value: 0
  - Adjustment range: -240~+240 (steps)
  - \*See above
3. Repeat this step for each channel.



# Function

Channel assignment for each function can be changed to suit your needs.

When you select model and wing (swash) types, you will find that the optimized combinations of servo output channels and functions have been already preset. If you would like, on the function-setting screen of the linkage menu, you can freely change combinations of servo output channels, functions (aileron, elevator, etc), and input controllers (sticks, switches, trim levers and trim switches). You can also assign the same function to multiple servo output channels such as assigning elevator function to CH2 and CH3.

## DG1, DG2 (switch channels)

These two channels can be used as switch (On/Off) channels. You can freely change combinations between servo output channels and input controllers (sticks, switches, trim levers and trim switches).

## Channel restrictions by a System Type

- FASSTest 18CH---16 CH+2 Switch
- FASSTest 12CH---10 CH+2 Switch
- FASST MULTI ---16 CH+2 Switch
- FASST 7CH --- 7 CH
- S-FHSS --- 8 CH
- T-FHSS ---16 CH+2 Switch

- Tap the [Function] button in the Linkage menu to call the setup screen shown below.

•Return to →  
Linkage menu

Ch	Function	Control	Trim
1	Aileron	J1	T1
2	Elevator	J3	T3
3	Throttle	J2	T2
4	Rudder	J4	T4
5	Gear	SG	--
6	Air brake	RS	--



## Function change

1. Tap the function button of the channel you want to change to call the Function select.

Function select	New-1 Condit1	
Aileron	Aileron2	Fuel mix
Elevator	Aileron2	Gyro
Throttle	Aileron4	Gyro2
Rudder	Elevator2	Gyro3
Gear	Flap2	Throttle2
Flap	Air brake	Throttle3

2. Select the function you want to change.

## Operation control change

1. Tap the control button of the channel you want to change. A control select screen (stick, switch, knob, trim lever, etc.) is displayed.

Hardware select	Model1 Condit1				
ON/OFF	--	J1	SA	SG	T1
Set		J2	SB	SH	T2
		J3	SC	SI	T3
		J4	SD	SJ	T4
		RD	SE	RS	T5
		LD	SF	LS	T6

2. Select the control you want to operate.

\*The same control can be assigned to multiple channels.



## Trim change

1. Tap the trim button to call the trim setup screen.

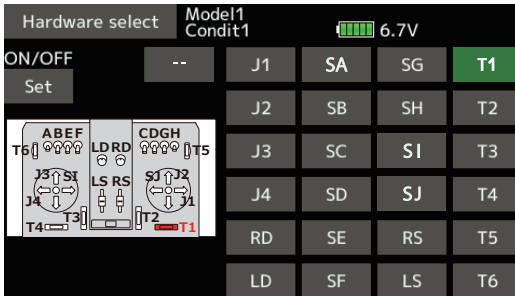

2. The following items can be set at the trim setup screen.

- Hardware setting (Selection of switch, etc. which controls trim)
- Rate setting
- Trim mode setting  
 Normal mode: Normal trim (linear) operation  
 ATL mode: ATL operation mode. (Works at only one end of operation) Reverse is also possible.  
 Center mode: Maximum change near center by center trim operation (Does not change at end of the stick movement)

The Motor function is used when switching the motor ON/OFF (mostly for motor gliders). For most EP planes, the throttle can be left as-is when controlling the motor by stick. This means that the various throttle-related functions are usable via motor control.

## H/W reverse

This function reverses the operation signal of the sticks, switches, trim levers, and knobs.

Note: This setting reverses the actual operation signal, but does not change the display of the indicators on the display. Use the Normal mode as long as there is no special reason to use the reverse mode.

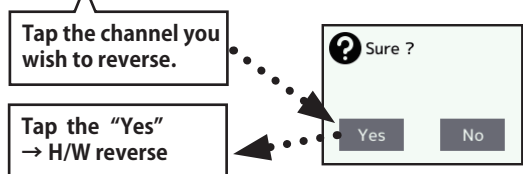
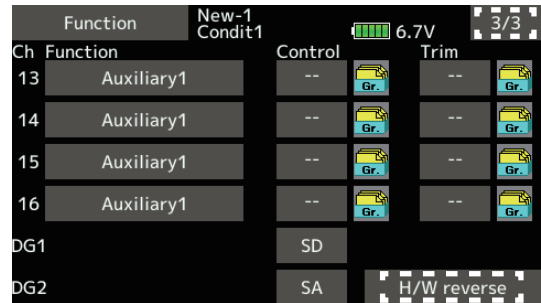



## Fail safe

Sets the servos' operating position when transmitter signals can no longer be received or when the receiver battery voltage drops.

The Fail safe function is used to set up positions that the servos will move to in the case of radio interference. Defines servo position when signals are lost and when receiver battery voltage becomes low.

You may set either of two positions for each channel: Hold, where the servo maintains its last commanded position, or fail safe, where each servo moves to a predetermined position. You may choose either mode for each channel.

The FX-36 system also provides you with an advanced battery monitoring function that warns you when the receiver battery has only a little power remaining. In this case, each servo is moved to the defined failsafe position. The battery failsafe may be released by operating a predefined control on the transmitter (default is throttle). **Do not continue to fly. Land as soon as possible.** Remember, if the predefined control suddenly

moves to a position you did not command, land at once and check your receiver battery.

**Do not continue to fly. Land as soon as possible.** Defines servo position when signals are lost and when receiver battery voltage becomes low.

### WARNING

#### For safety, always set the fail safe functions.

- Especially set the throttle channel fail safe function so that the servo moves to the maximum slow side for airplanes and to the slow side from the hovering position for helicopters. Crashing of the model at full high when normal radio waves cannot be received due to interference, etc., is very dangerous.
- If fail safe is reset by throttle stick movement, the fail safe may be mistaken as an engine malfunction and will be reset at low throttle and the model will continue to fly. If you have any doubts, immediately land.

- Tap the [Fail safe] button in the Linkage menu to call the setup screen shown below.

•Return to →  
Linkage menu

Fail safe		New-1 Condit1	B.F/S	6.7V F/S-POS	1/3
Ch	Function	Mode			Release battery F/S
1	Aileron	Hold	OFF	+0	
2	Elevator	Hold	OFF	+0	--
3	Throttle	Hold	OFF	+0	
4	Rudder	Hold	OFF	+0	
5	Gear	Hold	OFF	+0	
6	Air brake	Hold	OFF	+0	

### Fail safe setting procedure

Decide which channels you want to go to preset positions, and which ones you want to maintain their last commanded position. To select the fail safe mode you wish to set, use the F/S button. This button toggles between the two modes. (Hold, F/S)

#### F/S mode setting:

1. Tap the F/S button of the channel you want to set, and set that channel to the [F/S] mode.
2. Hold the corresponding stick, control, slider, or other control in the position you want the servo to move to when the fail safe function is activated, and tap the F/S position button. That position is displayed in percentage.

\*When you want to return that channel to the Hold mode, tap the [F/S] button again.

### Battery fail safe setting procedure

To select the B.F/S mode, tap the [B.F/S] button. Each time the button is tapped, it toggles between [OFF] and [B.F/S].

#### B.F/S setting:

1. Tap the [B.F/S] button of the desired channel to set it to the B.F/S mode.
2. Hold the corresponding stick, VR, slider, or other control in the position you want the servo to move to when the battery fail safe function is activated, and tap the F/S position button. This position is displayed in percentage.

\*When you want to return that channel to OFF, tap the [B.F/S] button again.

### Battery Fail safe release function

This function releases the predefined control from its held position after indicating that your receiver battery is low.

1. Enter the control setting screen by tapping the Battery F/S release button. Now, you may choose whether moving the throttle resets the condition, or select a stick or switch to deactivate it. To set a desired throttle release position, move the throttle stick to the point at which you wish the B.F/S to be released.





# System type

System mode setting, Receiver link

## System Type selection

The FX-36 is for 2.4GHz only. The system can be changed from among 6 choices: FASSTest 18CH, FASSTest12CH, FASST MULTI, FASST 7CH, T-FHSS, S-FHSS. It is FASSTest18CH and FASSTest12CH which can be chosen by R7008SB set. The method of selection is on the next page.

\*If you change the System type, other model data is not reset.

\*After any change, remember to test the model and fully check servo direction and motion.

\*Analog servos cannot be used with the R7008SB in the FASSTest12CH mode.

## Dual receiver function (only FASSTest 18CH )

Dual receivers can be linked with the FX-36. Two receivers are recognized individually by ID numbers. For example, in R7008SB, CH output setting function is used, by setting the first as "1-8CH", and setting the second as "9-16CH". Two sets of receivers can be used as a set in the model, allowing you 16 channels. Separate fail-safe voltage can be set to each receiver.

However, telemetry cannot be used for the 2nd receiver.

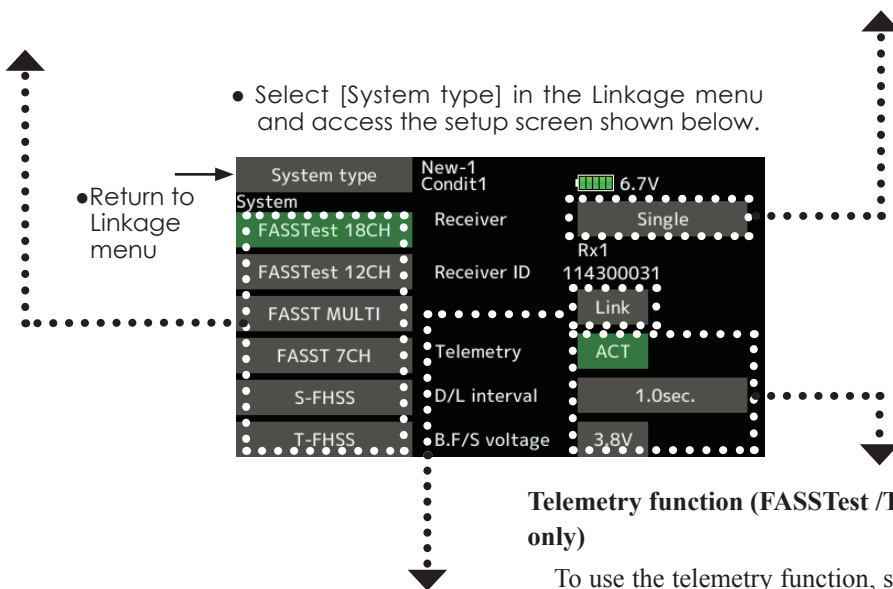

## Receiver linking

The receiver will only be controlled (without being affected by other transmitters) by the transmitter it is linked to. When using a receiver other than one purchased as a set, linking is necessary.

Moreover, a re-link is required when a new model is added by model selection, and at the time of system type change.

### Linking method

P.40

Cases when linking is necessary:

- When using a receiver other than the initial setting.
- When the communication system was changed. (FASSTest18CH ↔ FASSTest12CH etc.)
- When a new model was created by model selection.

## Telemetry function (FASSTest / T-FHSS mode only)

To use the telemetry function, set "Telemetry" to "ACT".

## DL Interval (FASSTest/T-FHSS mode only)

When a telemetry function is enabled, the receiving interval (down-link interval) of sensor data can be changed.

If a DL interval is increased, the response of the sensor data display becomes slower, but stick response will improve.

## Battery fail-safe voltage setup (FASSTest / T-FHSS mode only)

The voltage at which battery fail-safe activates can be set when you link. (3.5-8.4V) The receiver memorizes the setting as it was at link.

Since power consumption varies with battery type, servos and condition, please select the fail-safe activation voltage for your own model.



## The example for choosing System Type

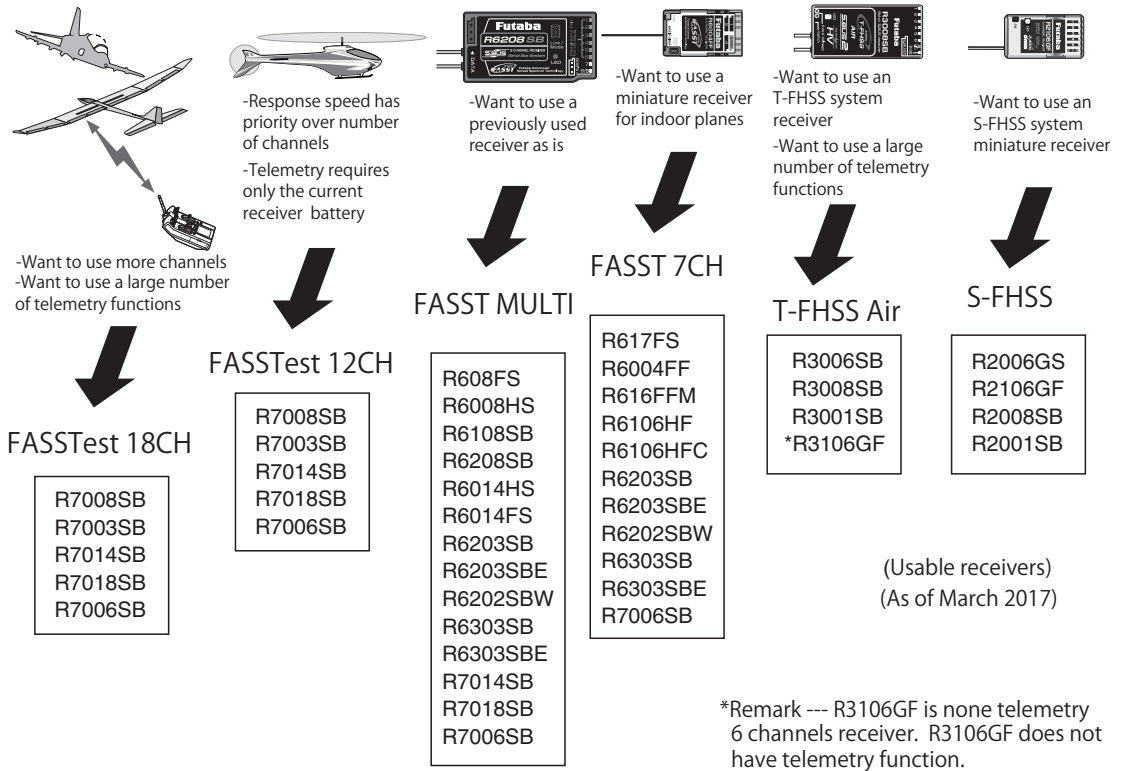

### System type

- **FASSTest 18CH** --- FASSTest system receiver mode. Applicable with the telemetry sensor unit. Up to 18 channels (linear16+ON/OFF2) can be used.
- **FASSTest 12CH** --- FASSTest system receiver mode. Applicable with receiver voltage display. Up to 12 channels (linear10+ON/OFF2) can be used. Telemetry Sensor cannot be used, but the response speed is faster than that of the 18CH mode.
  - **Analog servos cannot be used with the R7008SB in the FASSTest 12CH mode.**
- **FASST MULTI** --- FASST-MULTI system receiver mode. Up to 18 channels (linear16+ON/OFF2) can be used.
- **FASST 7CH** --- FASST-7CH system receiver mode. Up to 7 channels can be used.
- **T-FHSS Air** --- T-FHSS system receiver mode. Applicable with the telemetry sensor unit. Up to 18 channels (linear16+ON/OFF2) can be used.
- **S-FHSS** --- S-FHSS system receiver mode. Up to 8 channels can be used.



# Trim setting (T1-T6)

## Digital trim settings

This function adjusts the digital trim's control step amount and operation mode (T1-T6).

When the flight conditions are set, the trim operation can be coupled with among all the conditions which combination mode is selected.

- Select [Trim setting] at the linkage menu and call the setup screen shown below.
- Return to Linkage menu →

	Step	Mode	Step	Mode	
T1	4	Comb.	T4	4	Comb.
T2	4	Comb.	T5	4	Comb.
T3	4	Comb.	T6	4	Comb.

### Control step amount setting

1. The [Step] item tap the screen to the data input mode.

Set the control step amount by tapping the "▲▲" "▲" "▼▼" "▼" button.

Initial value: 4

Adjustment range: 1~200

(When the value is tapped, the control step amount is reset to the initial value.)

\*When the value is made large, the change per step becomes larger.

### Separate/combination mode selection

**[Comb.]:** Combination mode. The trim data are reflected at all the flight conditions.

**[Separ.]:** Separate mode. Trim adjustment for each flight condition.



# Throttle cut Stops the engine safely and easily.

Throttle cut provides an easy way to stop the engine, by flipping a switch with the throttle stick at idle. The action is not functional at high throttle to avoid accidental dead sticks. The switch's location and direction must be chosen, as it defaults to " -- ".

- Tap the [Throttle cut] button in the Linkage menu to call the setup screen shown below.

•Return to Linkage menu →

6.7V

100

50

0

**Tapping this will change INH to either OFF or ON and activated.**

**This is the throttle cut position. Tapping this will display value input buttons on-screen. Set the engine stop position.**

**The yellow line is the cut position. When the cut switch is ON, the throttle will move to this position.**

**Tapping this will pull up the hardware selection screen. Select the throttle cut switch and ON-OFF direction.**

**This indicates the throttle stick's current position. Throttle cut will only function when the throttle stick is more than 1/3rd into the slow throttle range.**

## Throttle cut setting procedure

1. Tap the "INH" button.
2. Throttle cut function switch setting:  
Tap the "--" button to call the <Hardware select> screen, and then select the switch and its ON direction.  
(For a detailed description of the selection method, see [Switch selection method] at the back of this manual.)
3. Throttle cut position setting:  
Tap the cut position button. Value input buttons appear on the screen.  
Use these buttons to adjust the cut position rate.

- Initial value: 17%
  - Adjustment range: (LOW) 0%~50% (Middle)
- \*With throttle stick at idle, adjust the rate until the engine consistently shuts off.

To exit the setting, tap the [Throttle cut] button.

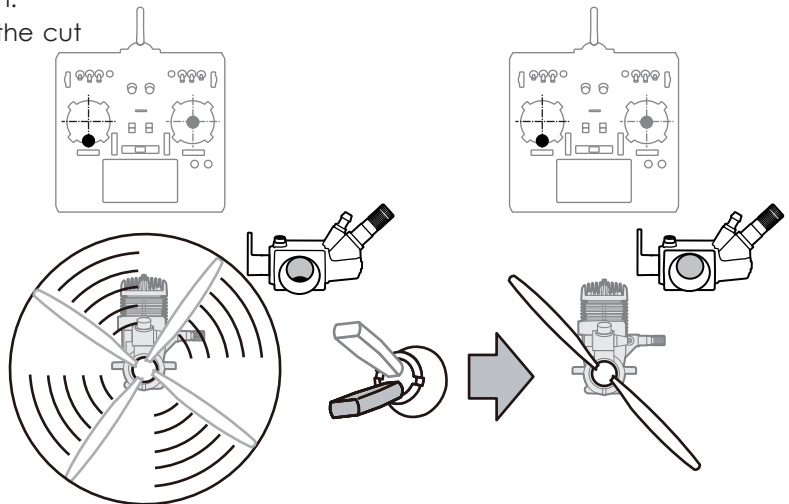



# Idle down

Lowers the engine idling speed.

The Idle down function lowers the engine's idle by flipping a switch with the throttle stick at idle. The action is not functional at high throttle to avoid accidental dead sticks. The switch's location and direction must be chosen, as it defaults to " -- ".

- Select [Idle down] at the linkage menu and call the setup screen shown below.

- Return to Linkage menu

**Tapping this will change INH to either OFF or ON and activated.**

**This is the idle down throttle position. Tapping this will display value input buttons on-screen. Set the engine's max. low position.**

**Range:  
(↑) -100 ~ +100 (↓)  
Pressing and holding a value will reset it to 0.**

**Tapping this will pull up the hardware selection screen. Select the idle down switch and ON-OFF direction.**

**This is the current position bar for the throttle stick. Throttle cut will only function when the throttle stick is more than halfway into the low throttle range.**

## Idle down setting procedure

1. Tap the "INH" button to activate the Idle down function.
2. Idle down function switch setting:  
Tap the "--" button to call the <Hardware select> screen, and then select the switch and its ON direction.  
(For a detailed description of the selection method, see [Switch selection method] at the back of this manual.)

3. Offset rate setting:  
Tap the offset rate button. Value input buttons appear on the screen.  
Use these buttons to adjust the offset rate.
  - Initial value: 0%
  - Adjustment range: -100%~100%
 \*(-)becomes an idle up.

To exit the setting, tap the [Idle down] button.

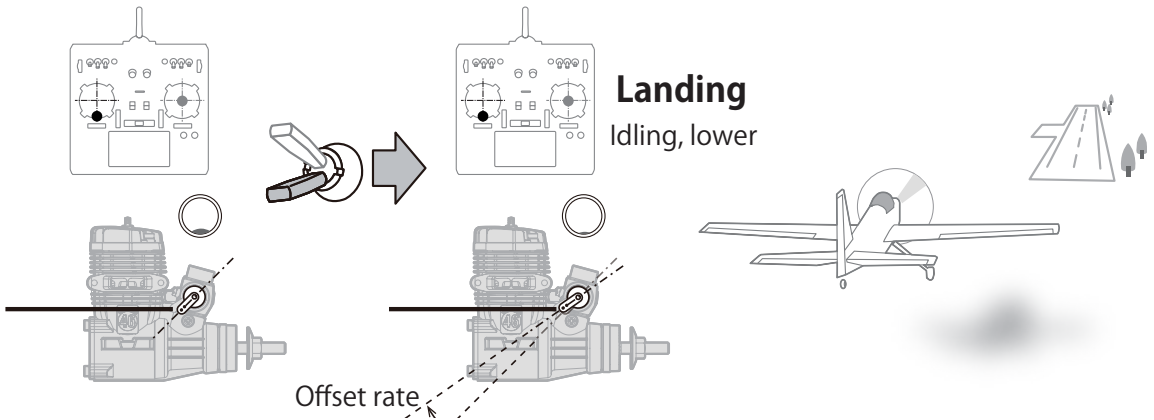



## Swash ring

Limits the swash travel within a fixed range to prevent linkage damage (Helicopter only)

This function limits the travel of the swash plate to prevent linkage damage as the aileron and elevator operation is used. It is useful for 3D heli setting.

- Tap the [Swash ring] button in the Linkage menu to call the setup screen shown below.

- Return to Linkage menu

The movement range display shows control input for elevator and aileron direction.

The marker represents the stick's position.

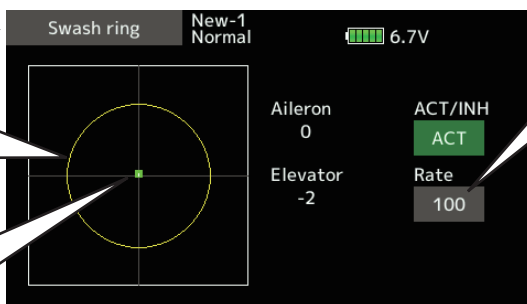

Setting the function to "ACT" will display the swash ring and [Rate] percentage.

### Swash ring setting procedure

1. Push the Swash ring button on the linkage menu.

2. Push ACT/INH button to activate.

\*The movement area monitor shows the current aileron and elevator values and limit ranges by the yellow circle.

3. Adjust the rate to the maximum amount of swash plate decline.

\*The swash movement is limited within the circle.

Adjustment range: 50 - 200%.



# Swash

Swash operation linkage correction function (helicopter only, except swash type H-1).

## Neutral Point

At your linkages, if the servo horn deviates from a perpendicular position at neutral, the linkage compensation functions in this menu may not compensate effectively. To correct this use the neutral point function. This will move the neutral point of the servos to the actual perpendicular position. However, this adjustment changes only the axis point of the compensation functions in this menu, and does not affect the neutral position of other functions.

## Swash AFR

Swash AFR function reduces/increases/reverses the rate (travel) of the aileron, elevator and collective pitch functions, by adjusting or reversing the motion of all servos involved in that function, only when using that function.

## Mixing Rate

This compensation mixing is used to correct the tendency of the swash-plate for each control. The following compensation mixing is possible: PIT to AIL, PIT to ELE, AIL to PIT, ELE to AIL, and ELE to PIT (HR3 mode.) It adjusts the swash-plate to operate correctly for each control using the corresponding compensation mixing.

## Linkage Compensation

This compensation mixing is used to correct the tendency of the swash-plate for pitch control at low pitch and high pitch.

## Speed Compensation

This function is used to cancel the reaction that is generated by the difference of the operation amount of each servo when the swash-plate moves.

- Select [Swash] at the linkage menu and call the setup screen shown below.

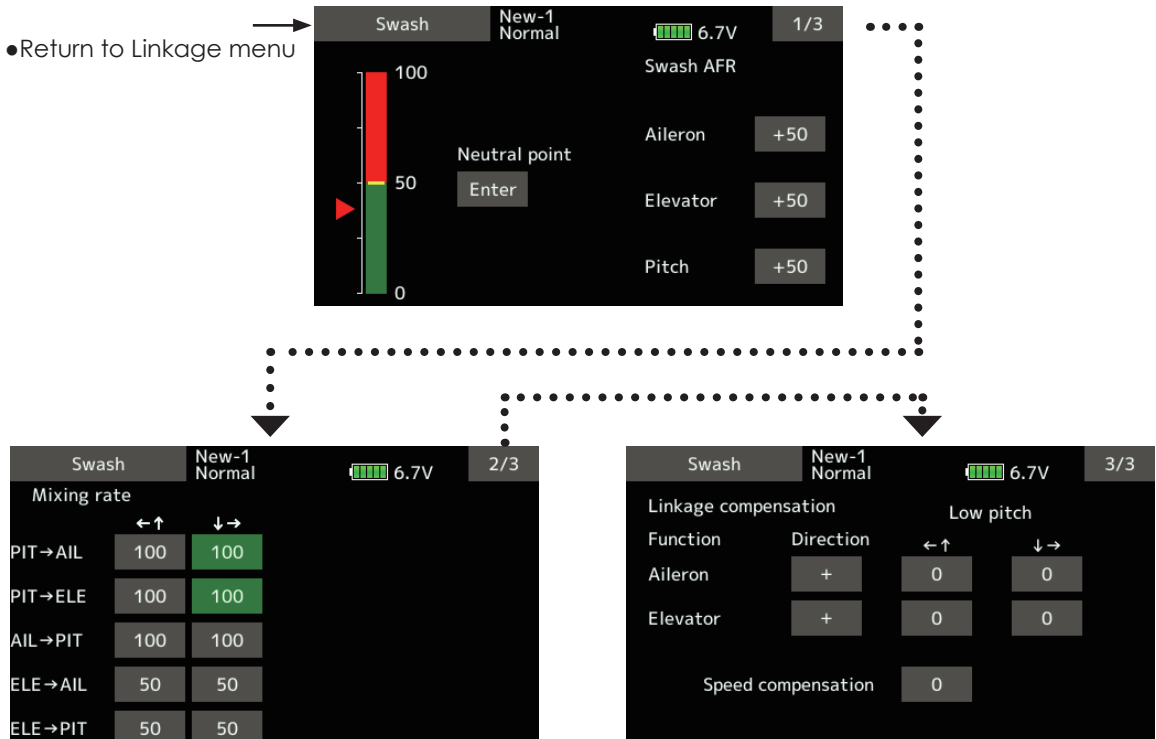



## Neutral point setting procedure

---

\*Becomes the compensation reference point.

\*Adjusting the servo horn so that the neutral point position is near the 50% position makes the mixing amount small.

1. Hold the servo horn at a right angle to the linkage rod, and then tap the [Enter] button and read the actual neutral point.

\*The neutral point is displayed on the screen.

After reading this neutral point, use other compensation functions to make further adjustments.

To exit the setting, tap the [Swash] button.

## Swash AFR setting procedure

---

Adjust so that the specified operation amount is obtained by aileron, elevator, and pitch operation.

1. Tap the button of the AFR rate to be adjusted. Value input buttons appear on the screen.
2. Use the value input buttons to adjust the AFR rate.

Initial value: +50%

Adjustment range: -100%~+100%

+or- the direction of operation changes.

To exit setting, tap the [Swash] button.

## Mixing rate setting procedure

---

HR-3 is described as an example. The mixing applied in other swash modes is different, but the setting procedure is the same.

1. Set the throttle stick to the set neutral point. Adjust the length of the linkage rod so that the swash plate is horizontal at this position.

\*A little adjustment using sub trim should be OK.

\*Adjust so that pitch operation when the pitch curve is straight is maximum.

2. Adjust the AIL->PIT amount so there is no interference in the elevator or pitch direction when the aileron stick is moved to the left and right.

\*Adjust the left and right sides separately.

3. Adjust the ELE->AIL and ELE->PIT amounts so there is not interference in the aileron or pitch direction when the elevator stick is moved up and down.

\*Adjust the up and down sides separately.

4. Adjust the PIT->AIL and PIT->ELE amounts so that the swash plate is horizontal when the throttle stick is set to maximum slow and full high.

\*Adjust the slow and high sides separately.

To exit setting, tap the [Swash] button.

## Linkage correction setting procedure

---

\*Set the linkage compensation after setting the mixing rate.

\*This function compensates for elevator interference by aileron operation or aileron interference by elevator operation at Low pitch and Hi pitch at collective pitch (HR3, etc.) control.

1. Set the throttle stick to the maximum slow position. Move the aileron stick to the left and right and adjust the aileron compensation amount so that interference in the elevator or pitch direction at that time is minimal.

\*The left and right sides can be adjusted separately.

\*If the interference increases when the compensation amount is increased, make the compensation direction "-".

2. Adjust the elevator compensation amount so that the interference in the aileron or pitch direction when the elevator stick is moved up and down is minimal.

3. Perform aileron and elevator compensation similarly for the throttle stick full high side.

To exit setting, tap the [Swash] button.

## Speed compensation setting procedure

---

1. Set the throttle stick to the neutral point position. Move the elevator stick quickly and adjust the speed compensation amount so that the interference in the pitch direction is minimal.

To exit setting, tap the [Swash] button.

### Notes:

If the linkage is too long or short, correct compensation will not be applied. Correct this before continuing. The pitch angle changes after any adjustment. Reset the pitch angle when actually flying after compensation processing.





# Stick alarm

An alarm (single beep) can be sounded at the specified throttle stick position.

- Alarm function ON/OFF can be set by switch.

•Return to Linkage menu

Stick alarm New-1 Normal

6.7V

100

50

0

ACT/INH INH

Position 50

Switch --

Tapping this will change INH to ON and activated.

If the throttle stick reaches the yellow line, an alarm will sound.

This is the current position display bar for the throttle stick.

Tapping this will pull up the hardware selection screen. Select the switch and ON-OFF direction if turning the function ON-OFF by switch.

This is the throttle stick alarm position. Push the throttle stick to the desired position and tap the value.

Range:  
(Low) 0 ~ 100 (High)

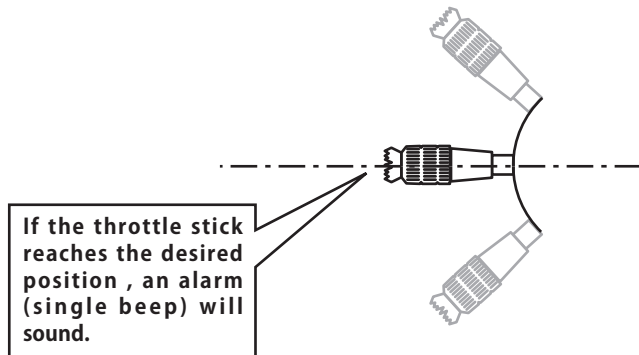



# Timer

## Timer setting

The Timer function may be set for any desired time, i.e. engine run time, specified times for competitions, etc. Two independent timers are provided for your use. The timers are stored independently with each model, meaning that when you switch between model setups, the timer associated with the new model is brought up automatically.

The timers may be set to start and stop from the motion of any switch or stick. You may set the ON and OFF directions freely. Each timer has a capacity of up to 59 minutes 59 seconds.

- Select [Timer] at the linkage menu and call the setup screen shown below.

•Return to Linkage menu →

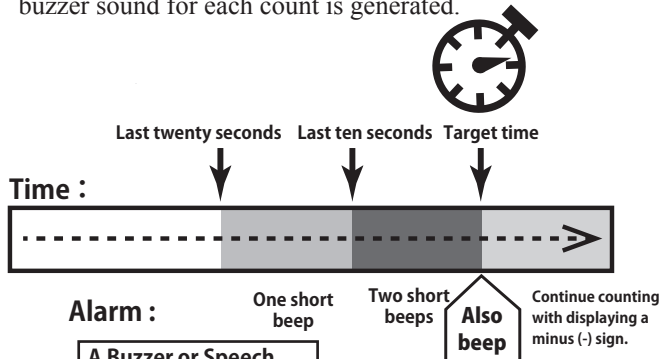
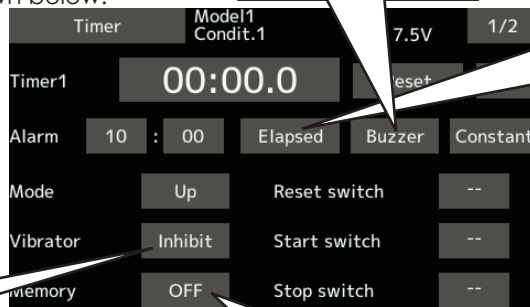

Elapsed: Minute-by-minute alarm starting from 00:00  
 Remainder: Minute-by-minute alarm counting down from a designated time

Constant: The alarm does not stop  
 One time: Stop the alarm at once

[Inhibit] → [Type1-4]  
 If it carries out like this, a vibration function will work.

OFF: Turning the power OFF and switching models will reset the timer.  
 ON: Previous timer is put into memory and will restart from where it stopped.

[Start/Stop] → Home screen  
 A timer on the home screen starts and stops its countdown directly from there when tapped. Tapping and holding the display will reset the timer.

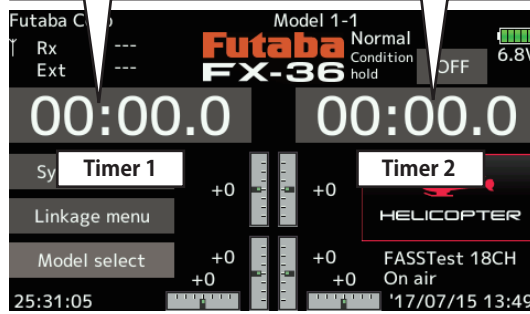

### Up timer/Down timer selection

1. Tap the mode button and select the type of timer.
2. Timer time setting.  
 Tap the Mode minutes or seconds button. Value input buttons appear on the screen. Use these buttons to set the timer time.

### Start/Stop/Reset switch setting

1. Tap the Start/Stop/Reset SW "--" button to call the <Switch> screen, and then select the switch and its ON direction.  
 (For a detailed description of the selection method, see [Switch selection method] at the back of this manual. The timer switches can be set for each condition.)



## Integration Timer

INT (integration) Timer is the function which changes progress of a timer according to the location of the throttle stick. When the throttle stick is raised for faster speed, the speed of the timer usually increases. With the throttle stick at mid-range speed, the timer speed decreases (to 50%). When the throttle is positioned at low end, the timer's progress stops. It's possible to set it in the time which fits power consumption of your fuselage.

\*The consumption of the battery/fuel is different depending on the conditions, so use an INT Timer as reference.

\*The INT (integration) time is different from the actual elapsed time.

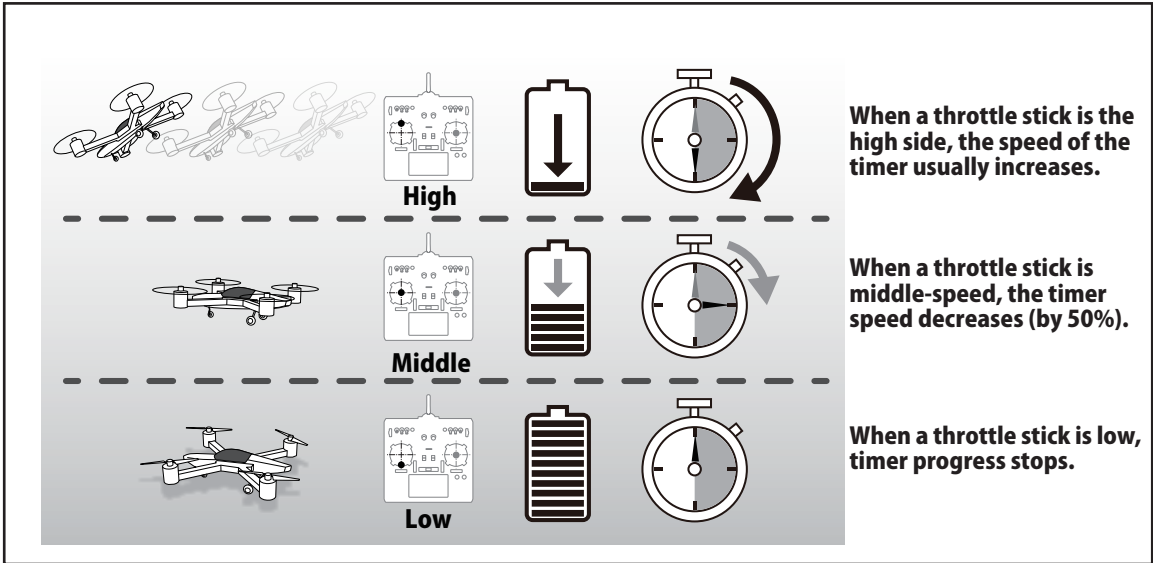

- Select [Timer] at the linkage menu and call the setup screen shown below.

**◆ Start INT timer**

The screenshot shows the following interface elements:

- Top status bar: Timer, New Normal, 6.9V, 1/2
- Timer1: 01:50.0 (with a callout 'INT Time' pointing to the timer value)
- Reset button and TH% button (with a callout 'Tap' pointing to it)
- INT time (%): 18% (with a callout 'INT time (%)' pointing to it)
- Alarm: 10 : 00, Elapsed, Speech
- Mode: Up, Reset switch, --
- Vibrator: Inhibit, Start switch, --
- Memory: OFF, Stop switch, --

Nomal Timer  
TH% : Integration Timer



## Function name

Function name can be changed

The name of the spare functions (Auxiliary 1-8) can be changed for the full name (10 characters) or for the abbreviated name (4 characters).

- Tap the [Function name] button in the Linkage menu to call the setup screen shown below.

- Return to Linkage menu →

Function name	New-1 Normal	6.7V
AUX1	Auxiliary1	AUX1
AUX2	Auxiliary2	AUX2
AUX3	Auxiliary3	AUX3
AUX4	Auxiliary4	AUX4
AUX5	Auxiliary5	AUX5
AUX6	Auxiliary6	AUX6
AUX7	Auxiliary7	AUX7
AUX8	Auxiliary8	AUX8

Rename

Reset

### Function name change method

1. Select [Function name] from the Linkage menu and tap the screen.
2. The Function name setup screen is displayed.
3. When the function whose name is to be changed is selected and the screen is tapped, a modification screen is displayed.
4. Select the function to be renamed and select [Rename] and tap the screen. A character input screen is displayed. Input the function name.
6. The function name may be displayed in 10 characters or 4 characters, depending on the setup screen. For 4-character display, input the function name as required.

Function name	New-1 Normal	6.7V	1/4
	←	→	BS Undo
0	1	2	3
4	5	6	7
8	9	A	B
C	D	E	F
G	H	I	J
K	L	M	N
O	P	Q	R
S	T	U	V
W	X	Y	Z
a	b	c	d
e	f	g	h
i	j	k	l
m	n		

5. When [Reset] is selected and the screen is held down, the function name is set to the initial state function name.



# Telemetry system

This screen displays and sets the various information from the receiver. An alarm and vibration can be generated depending on the information. For example, a drop in the voltage of the receiver battery housed in the aircraft can be reported by an alarm.

- This function can only be used in the FASSTest18CH mode and T-FHSS mode. The FASST/S-FHSS mode cannot use telemetry.
- FASSTest12CH mode. Applicable with receiver voltage display.
- Telemetry sensors sold separately can be mounted in the aircraft to display a variety of information. (Receiver voltage does not require a sensor.)
- The telemetry function cannot be used if the telemetry mode of the parameters is not ACT.
- FASSTest18CH : When 2 receivers are used with 1 transmitter, the telemetry cannot be used for the 2nd receiver.
- T-FHSS/FASSTest12CH : When 2 receivers are used with 1 transmitter, the telemetry function cannot be used.
- If the transmitter and receiver are linked, but the receiver's ID is not recorded in the transmitter's memory, the telemetry function cannot be used.
- Turning OFF the receiver after use will cause the telemetry data just prior to this to be displayed. (Even when the receiver's power is turned OFF, the receiver voltage is not 0.0V.)

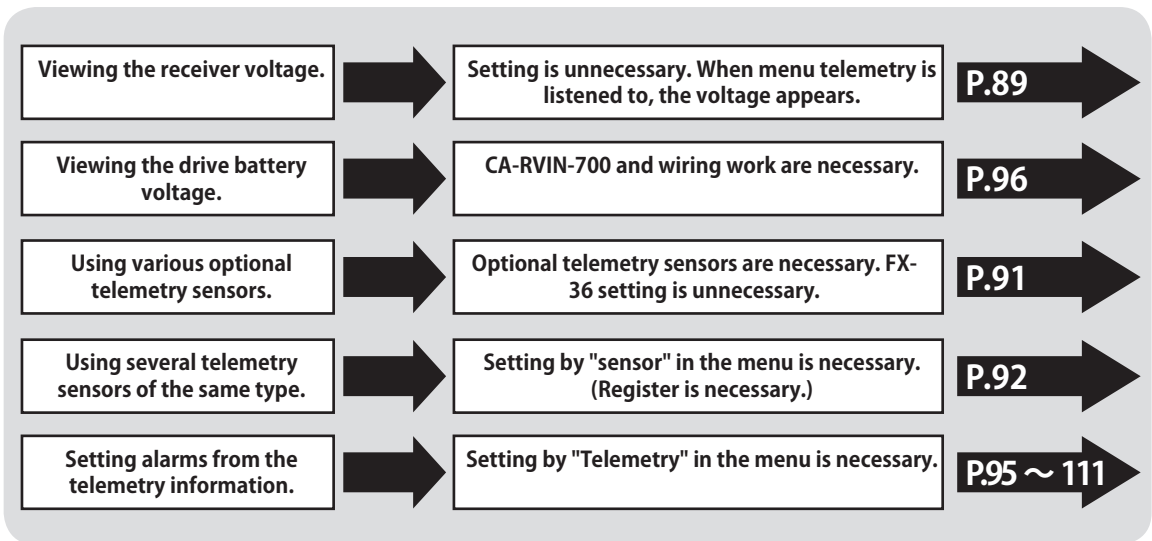

## Viewing the telemetry data

Receiver → Transmitter. The reception of the signal from the receiver to the transmitter is shown. This does not affect flight.

Receiver voltage and Ext voltage display

**CAUTION**

Do not stare at or set the transmitter setting screen while flying.

- Losing sight of the aircraft during flight is very dangerous.
- When you want to check the information during flight, call the telemetry screen before flight and have the screen checked by someone other than the operator.



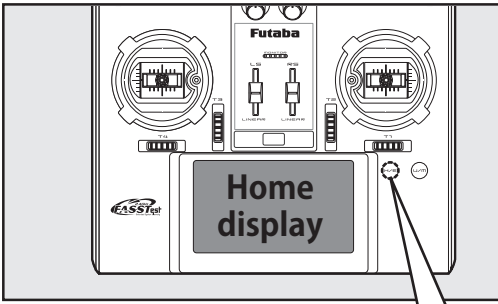

**H/E is pushed**

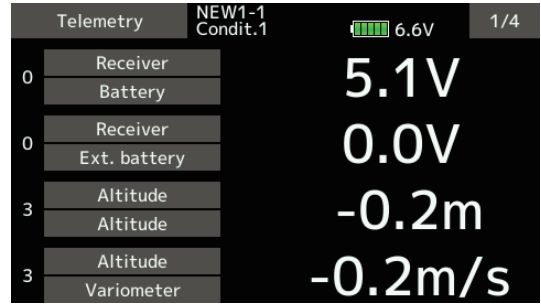

**16 of telemetry data is displayed**

\*Be aware that pressing and holding this activates the key lock

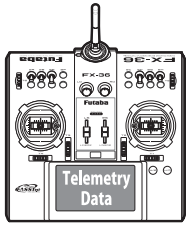
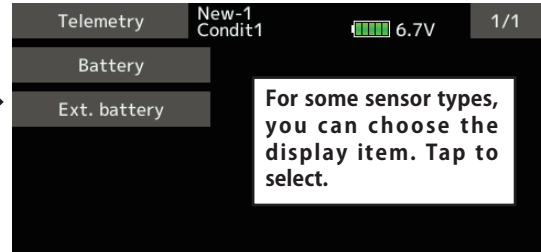
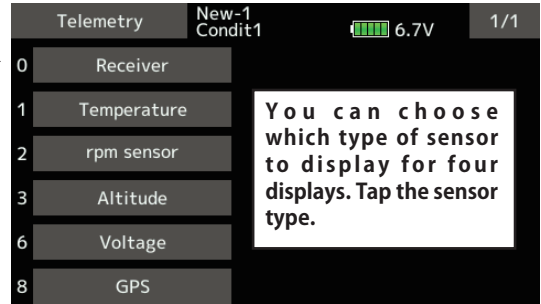
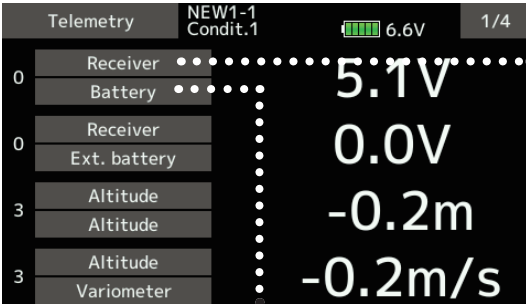

FX-36

**Telemetry Schematic**

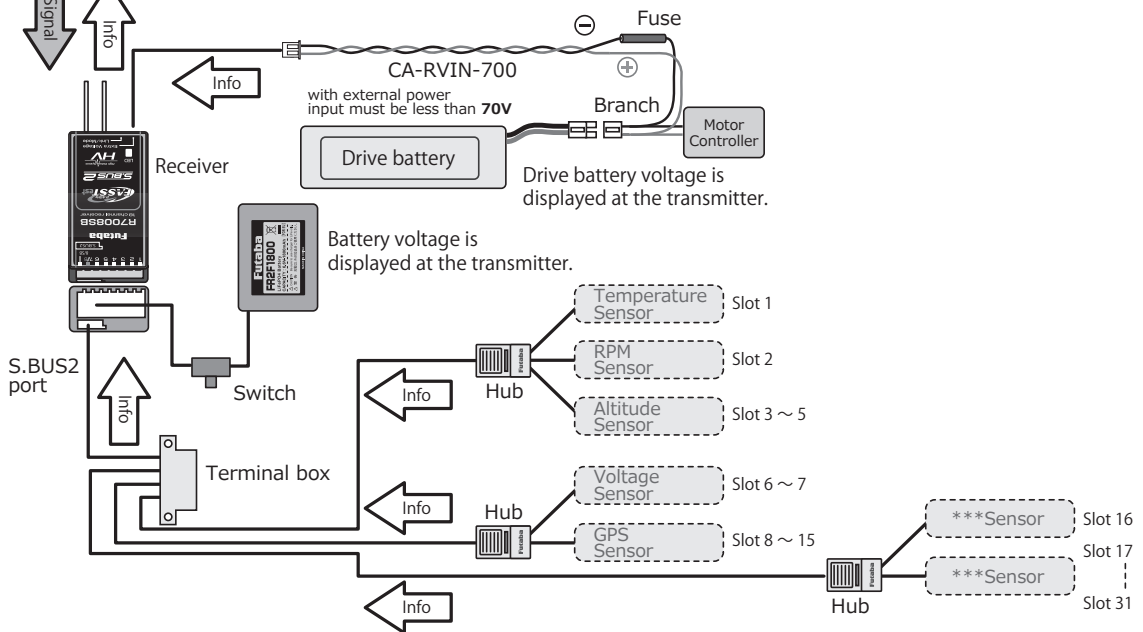





## Sensor : Reload

This page is set when using multiple telemetry sensors of the same type.

When using multiple sensors of the same type the sensors must be registered in the transmitter. Connect all the sensors to be used to the FX-36 as shown in the figure at the right and register them by the following procedure. The ID of each sensor is registered in the transmitter.

- Call page 3/3 from the [Sensor] menu.

- Return to → Linkage menu

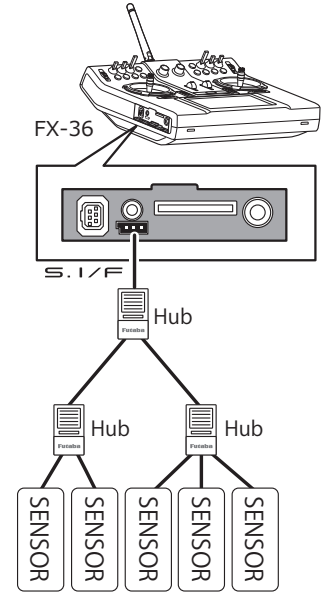
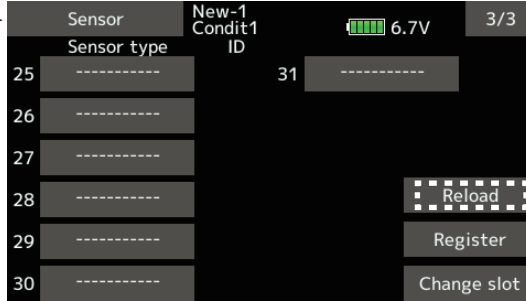

### Reading all the sensors to be used

1. Connect the sensor to the FX-36 as shown in the figure above.
2. Tap "Reload" on page 3/3 of the [Sensor] screen.
3. Tap "Reload".

All the sensors are registered and can be used.

\*It is not necessary to carry out multiple battery connections like a T18MZ/T14SG.

## Sensor : Register

This page is set when using multiple telemetry sensors of the same type.

This function registers an additional sensor. Connect the sensor as shown in the figure at the right and register it by the following procedure. The sensor ID is registered in the transmitter.

- Call page 3/3 from the [Sensor] menu.

- Return to → Linkage menu

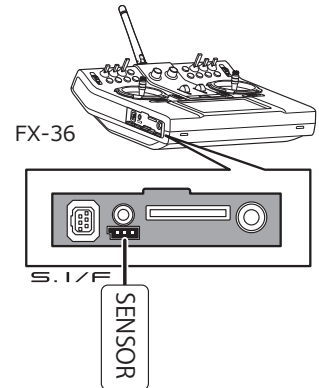
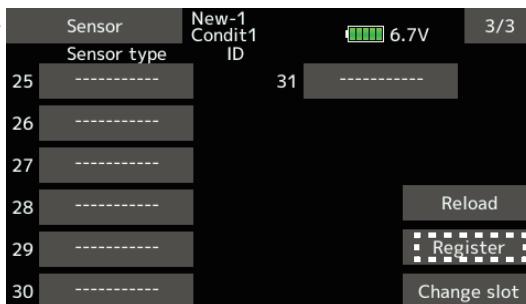

\*It is not necessary to carry out multiple battery connections like a T18MZ/T14SG.

### Additional sensor registration

1. Connect the sensor to the FX-36 as shown in the figure above.
2. Tap "Register" on page 3/3 of the <Sensor> screen.
3. The sensor is registered and can be used.

\*When the number of slots needed in registration is insufficient, an error is displayed and registration cannot be performed. Disable unused slots or perform the following reload.





# Sensor : Change slot

This page is set when using multiple telemetry sensors of the same type.

This procedure changes the slot number of one registered sensor.

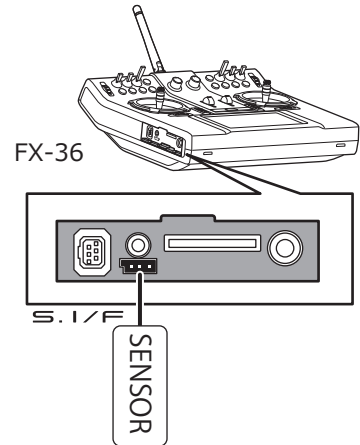

\*It is not necessary to carry out multiple battery connections like a T18MZ/T14SG.

- Call page 3/3 from the [Sensor] menu.

- Return to Linkage menu

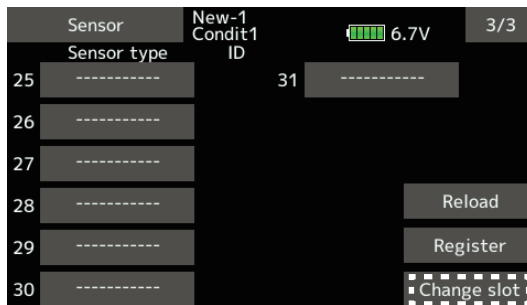

- Tap the [Change slot] button in the Sensor screen to call the setup screen shown below.



\*For some transmitters (e.g., T6K), when the start slot of a sensor is changed, the sensor cannot be used.

## Sensor slot change

1. Connect the sensor to the FX-36 as shown in the figure above.
2. Tap "Change slot" on page 3/3 of the <Sensor> screen.
3. Tap "Read".
4. A sensor details screen appears.
5. The current start slot is displayed. To change a start slot, a + - button, tap. (Cannot be set to a slot that cannot be allocated like the table of all pages.)
6. Tap to the "Write".

### ⚠ WARNING

⊘ Do not disconnect or turn transmitter power OFF while telemetry sensor data is being saved.

- Sensor save data will be lost, resulting in malfunction.



# Telemetry

Displaying data from the receiver

This screen displays your choice of data from the receiver.

Also warnings can be activated regarding the data. For example, if the receiver voltage drops, the user can be warned by an alarm (and vibration).

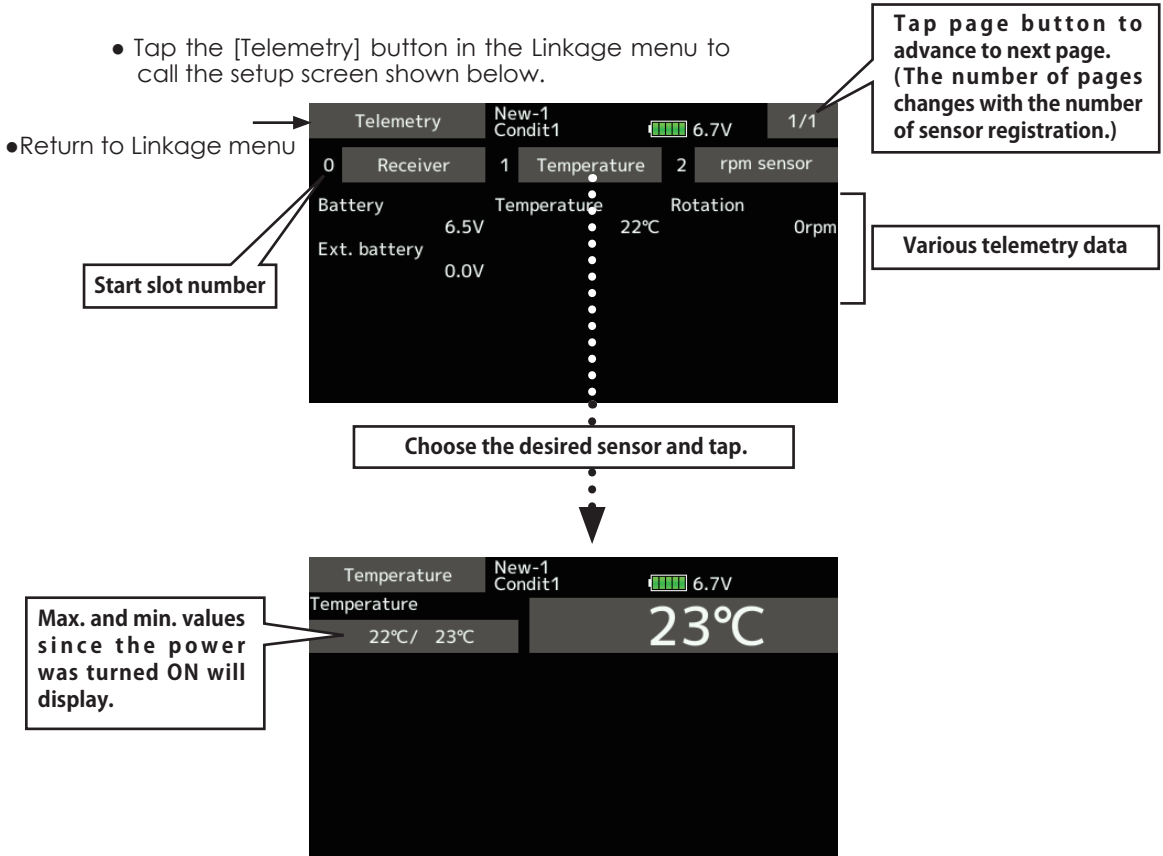

## Display Sensors

Default display sensors can only be used by connecting the sensors to the receiver. For display of other sensors or to use the same type of sensor in multiple cases, either register them via the "Sensor" option on the Linkage menu or allocate the sensors to empty slots to have them display on the Telemetry screen. Refer to the previous "Sensor" explanation pages for how to do this.



# Telemetry: Receiver [Battery]

Displaying data from the receiver battery voltage

In this screen, the battery voltage of a receiver is displayed.

If it becomes higher or lower than the setting, an alarm and/or vibration will alert you.

\*It cannot be used in FASST mode and S-FHSS mode.

\*Only receiver voltage and EXT voltage can be used in FASSTest12CH mode.

\*The FASSTest18CH /T-FHSS mode can use all the telemetry functions.

- Tap the [Receiver] button in the Telemetry screen to call the setup screen shown below.

•Return to Linkage menu

Receiver New-1 Condit1 6.7V

Battery 6.3V/ 6.3V 6.3V

Ext. battery 0.0V/ 0.0V 0.0V

Receiver battery voltage

Max. and min. values since the power was turned ON will display.

↓ The "down" arrow will indicate that an alarm will sound when the voltage drops to below the setting.

Alarm Inhibit Vibrator Inhibit Limit 4.0V

Speech OFF

Sets the voltage on which the alarm operates.

Alarm is chosen from Buzzer, Voice, and Inhibit.

Allows Speech to be turned ON or OFF.

## Alarm set

1. Tap Alarm and choose from Buzzer, Voice, and Inhibit.
2. Choose "Inhibit" for Vibrator if not using the vibrator alarm. If using vibrator, choose one of the three types.
3. Tap to the Limit [4.0V] item.
4. Adjust the rate using the "▼▼▼" "▼" "▲" "▲▲▲" buttons.  
Initial value: 4.0V  
Adjustment range: 0.0V~100.0V  
\*When the screen is tapped for one second, the rate is reset to the initial value.
5. To terminate the input and return to the original state, push the H/E button.

**"Vibrator" type**

If the following types are selected, the transmitter will vibrate during the warning.

Type 1 →

Type 2 → →

Type 3 → → →



# Telemetry: Receiver [Ext. battery]

Displaying data from the EXT battery voltage port

\*CA-RVIN-700 must be installed in the aircraft.

The EXT-VOLT screen will display the data from the EXT-battery output from the R7008SB receiver. In order to use this function, it is necessary to connect external voltage connector of the R7008SB receiver to a CA-RVIN-700 or SBS-01V to the battery you desire to measure the voltage of the EXT-battery.

You will be alerted by an alarm or vibration if the voltage set by you is exceeded.

\*It cannot be used in FASST mode and S-FHSS mode.

\*Only receiver voltage and EXT voltage can be used in FASSTest12CH mode.

\*The FASSTest18CH /T-FHSS mode can use all the telemetry functions.

- Tap the [Receiver] button in the Telemetry screen to call the setup screen shown below.

•Return to Linkage menu

Max. and min. values since the power was turned ON will display.

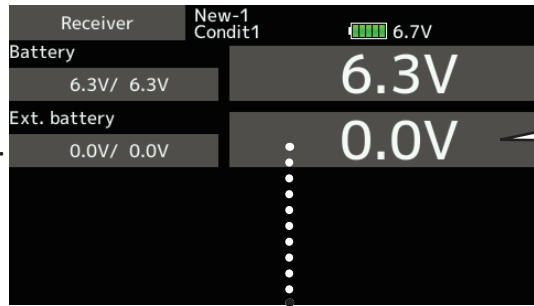

Ext. battery voltage

↓ The "down" arrow will indicate that an alarm will sound when the voltage drops to below the setting.

Alarm is chosen from Buzzer, Voice, and Inhibit.

Allows Speech to be turned ON or OFF.

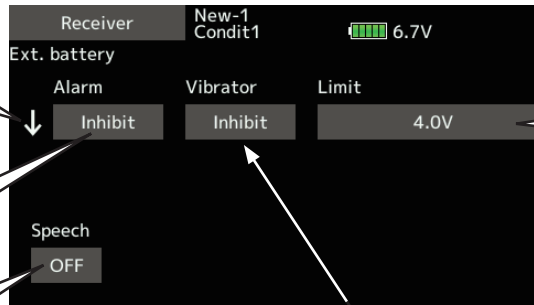

Sets the voltage on which the alarm operates.

### Alarm set

1. Tap Alarm and choose from Buzzer, Voice, and Inhibit.
2. Choose "Inhibit" for Vibrator if not using the vibrator alarm. If using vibrator, choose one of the three types.
3. Tap to the Limit [4.0V] item.
4. Adjust the rate using the "▼▼▼" "▼" "▲" "▲▲▲" buttons.  
Initial value: 4.0V  
Adjustment range: 0.0V~100.0V  
\*When the screen is tapped for one second, the rate is reset to the initial value.
5. To terminate the input and return to the original state, push the H/E button.

**"Vibrator" type**

If the following types are selected, the transmitter will vibrate during the warning.

Type 1 →

Type 2 → →

Type 3 → → → →



# Telemetry : Temperature

Displaying data from the temperature

\*A temperature sensor must be installed in the aircraft.

Temperature is a screen which displays/sets up the temperature information from an optional temperature sensor.

\*It cannot be used in FASST mode and S-FHSS mode.

\*Only receiver voltage and EXT voltage can be used in FASSTest12CH mode.

\*The FASSTest18CH /T-FHSS mode can use all the telemetry functions.

The temperature of the model (engine, motor, battery, etc.) which is flying can be displayed.

If it becomes higher or lower than the setting, an alarm and/or vibration will alert you.

- Tap the [Temperature] button in the Telemetry screen to call the setup screen shown below.

•Return to Linkage menu

Temperature New-1 Condit1 6.7V

Temperature 23°C/ 25°C 24°C

Max. and min. values since the power was turned ON will display.

↑ An upward arrow will show that an alarm will sound when the temperature rises above the set value.

↓ A downward arrow will show that an alarm will sound when the temperature drops below the set value.

Alarm is chosen from Buzzer, Voice, and Inhibit.

Allows Speech to be turned ON or OFF.

Temperature New-1 Condit1 6.7V

Alarm	Vibrator	Limit
↑ Inhibit	Inhibit	100°C
↓ Inhibit	Inhibit	0°C

Speech OFF

Sets the temperature on which the alarm operates.

## Alert set : Temperature warning

1. Tap Alarm and choose from Buzzer, Voice, and Inhibit.
2. Choose "Inhibit" for Vibrator if not using the vibrator alarm. If using vibrator, choose one of the three types.
3. Tap to the Limit [°C] item .
4. Adjust the rate using the "▼▼▼" "▼" "▲" "▲▲▲" buttons.  
 Initial value: ↑100°C ↓0°C  
 Adjustment range: -20°C ~200°C  
 (↑Limit ≥ Limit)  
 \*When the screen is tapped for one second, the rate is reset to the initial value.
5. To terminate the input and return to the original state, push the H/E button.

### "Vibrator" type

If the following types are selected, the transmitter will vibrate during the warning.

Type 1

Type 2

Type 3



# Telemetry : RPM Sensor

The RPM Sensor screen is used to set up an optional rpm sensor and display the rotation information it transmits.

The rotation of the model (engine, motor, etc.) which is flying can be shown.

If it becomes higher or lower than the setting, an alarm and/or vibration will alert you.

Displaying data from the rpm

\*An rpm sensor must be installed in the aircraft.

\*It cannot be used in FASST mode and S-FHSS mode.

\*Only receiver voltage and EXT voltage can be used in FASSTest12CH mode.

\*The FASSTest18CH /T-FHSS mode can use all the telemetry functions.

- Tap the [rpm sensor] button in the Telemetry screen to call the setup screen shown below.

•Return to Linkage menu

Max. and min. values since the power was turned ON will display.

↑ An upward arrow will show that an alarm will sound when the rpm rises above the set value.

↓ A downward arrow will show that an alarm will sound when the rpm falls below the set value.

Alarm is chosen from Buzzer, Voice, and Inhibit.

Allows Speech to be turned ON or OFF.

Sets the rpm on which the alarm operates.

"Magnet"	SBS-01RM →	Gear ratio	1.00~99.00
"Optics"	SBS-01RO →	Blade	2~10
"Brushless motor"	SBS-01RB →	Pole	2~30

## Alarm set : Over (Under) rotations

1. Tap Alarm and choose from Buzzer, Voice, and Inhibit.
2. Choose "Inhibit" for Vibrator if not using the vibrator alarm. If using vibrator, choose one of the three types.
3. Tap to the Limit [xxx rpm] item .
4. Adjust the rate using the "▼▼▼" "▼" "▲" "▲▲▲" buttons.  
Initial value: ↑ 2,000rpm ↓ 0rpm  
Adjustment range: 0rpm~150,000rpm  
(↑Limit ≥ ↓Limit)

\*When the screen is tapped for one second, the rate is reset to the initial value.

5. To terminate the input and return to the original state, push the H/E button.

## "Vibrator" type

If the following types are selected, the transmitter will vibrate during the warning.

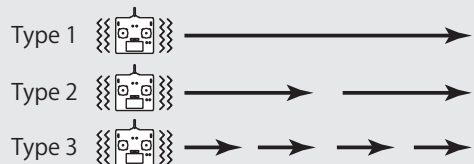



# Telemetry : Altitude

Displaying data from the altitude

\*An altitude sensor or GPS sensor must be installed in the aircraft.

Altitude is a screen which displays / sets up the altitude information from an optional altitude sensor or GPS sensor. The altitude of the model which is flying can be known. If it becomes higher (low) than preset altitude, you can be told by alarm. Warning by vibration can also be chosen. Data when a power supply is turned on shall be 0 m, and it displays the altitude which changed from there. Even if the altitude of an airfield is high, that shall be 0 m and the altitude difference from an airfield is displayed. This sensor calculates the

altitude from atmospheric pressure. Atmospheric pressure will get lower as you go up in altitude. Using this, the sensor will estimate the altitude. Please understand that an exact advanced display cannot be performed if atmospheric pressure changes in a weather situation.

- \*It cannot be used in FASST mode and S-FHSS mode.
- \*Only receiver voltage and EXT voltage can be used in FASSTest12CH mode.
- \*The FASSTest18CH /T-FHSS mode can use all the telemetry functions.

- Tap the [Altitude] button in the Telemetry screen to call the setup screen shown below.

•Return to Linkage menu

Max. and min. values since the power was turned ON will display.

↑ An upward arrow indicates the alarm will sound when the altitude reaches above your set value.

↓ A downward arrow indicates the alarm will sound when the altitude reaches below your set value.

Alarm is chosen from Buzzer, Voice, and Inhibit.

Allows Speech to be turned ON or OFF.

Allows Melody to be turned ON or OFF.

Sets the altitude on which the alarm operates.

● If this is set to Mode1-4, a rise and dive are told by a different melody.  
 Mode1: Little rise/dive → Melody changes : sensitively  
 ⋮  
 Mode4: Big rise/dive → Melody changes : insensible

## First, the set of a reference is required.

1. The model and transmitter to which the altitude sensor was connected are turned on.
2. Tap to the [Preset] of "Reference" item.

\*Atmospheric pressure is changed according to the weather also at the same airfield. You should preset before a flight.

## "Vibrator" type

If the following types are selected, the transmitter will vibrate during the warning.

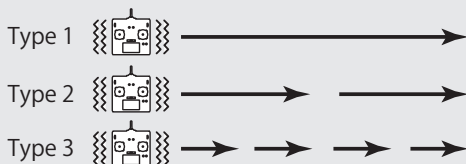

## Alarm set : Altitude

1. Tap Alarm and choose from Buzzer, Voice, and Inhibit.
2. Choose "Inhibit" for Vibrator if not using the vibrator alarm. If using vibrator, choose one of the three types.
3. Tap to the Limit [xxx m] item .
4. Adjust the rate using the "▼▼" "▼" "▲" "▲▲" buttons.  
 Initial value: ↑200m ↓-50m  
 Adjustment range -500m~+3,000m (↑Limit ≥ ↓Limit)  
 \*When the screen is tapped for one second, the rate is reset to the initial value.
5. To terminate the input and return to the original state, push the H/E button.



# Telemetry : Altitude [Variometer]

Displaying data from the variometer

\*An altitude sensor or GPS sensor must be installed in the aircraft.

VARIO is a screen which displays / sets up the variometer information from an optional altitude sensor or GPS sensor.

The variometer of the model which is flying can be known.

If it becomes higher or lower than the setting, an alarm and/or vibration will alert you.

To ensure that the pilot is aware as to the model's

status, the FX-36 incorporates a different melody for ascent and descent. Additionally, depending upon the rate of climb or descent, the tones vary to indicate whether or not the airplane is climbing or descending at a rapid rate.

\*It cannot be used in FASST mode and S-FHSS mode.

\*Only receiver voltage and EXT voltage can be used in FASSTest12CH mode.

\*The FASSTest18CH /T-FHSS mode can use all the telemetry functions.

- Tap the [Variometer] button in the Telemetry screen to call the setup screen shown below.

•Return to Linkage menu

Max. and min. values since the power was turned ON will display.

↑ An upward arrow indicates the alarm will sound when the variometer reaches above your set value.

↓ A downward arrow indicates the alarm will sound when the variometer reaches below your set value.

Alarm is chosen from Buzzer, Voice, and Inhibit.

Allows Speech to be turned ON or OFF.

Allows Melody to be turned ON or OFF.

Sets the variometer on which the alarm operates.

Variometer

• If this is set to Mode1-4, a rise and dive are told by a different melody.

Mode 1 : Little rise/dive → Melody changes : sensitively

Mode 4 : Big rise/dive → Melody changes : insensible

First, the set of a reference is required.

1. The model and transmitter to which the altitude sensor was connected are turned on.
2. Tap to the [Preset] of "Reference" item.

\*Atmospheric pressure is changed according to the weather also at the same airfield. You should preset before a flight.

## Alert set : variometer

1. Tap Alarm and choose from Buzzer, Voice, and Inhibit.
2. Choose "Inhibit" for Vibrator if not using the vibrator alarm. If using vibrator, choose one of the three types.
3. Tap to the Limit [m/s] item .
4. Adjust the rate using the "▼▼" "▼" "▲" "▲▲" buttons.  
Initial value: +1m  
Adjustment range-50m/s~+50m/s  
(↑Limit ≥ ↓Limit)  
\*When the screen is tapped for one second, the rate is reset to the initial value.
5. To terminate the input and return to the original state, push the H/E button.

## "Vibrator" type

If the following types are selected, the transmitter will vibrate during the warning.

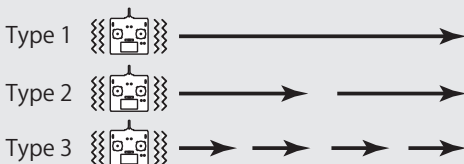





## Vario Melody Setting



Tap the [Set] button

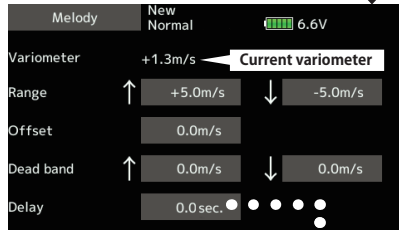

\*These settings can be made for each sensor.

### Range

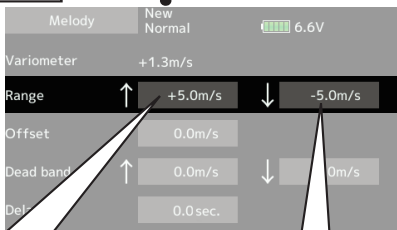

When the variometer is greater than this value, Vario melody is not variable.  
**Setting range :**  
 Offset value ~ +50m/s  
**Initial value :** 5.0m/s

When the variometer is less than this value, Vario melody is not variable.  
**Setting range :**  
 -50m/s ~ Offset value  
**Initial value :** -5.0m/s

### Deadband



When the variometer is less than this value, Vario melody is not output.  
**Setting range :** 0m/s ~ +50m/s  
**Initial value :** 0.0m/s

When the variometer is greater than this value, Vario melody is not output.  
**Setting range :** -50m/s ~ 0m/s  
**Initial value :** 0.0m/s

### Offset



This is the changing point of climb and sink. When the variometer is greater than this value, Vario Melody is climb type. When the variometer is less than this value, Vario Melody is sink type.  
**Setting range :** Range ↑ setting value ~ Range ↓ setting value  
**Initial value :** 0.0m/s

### [The relation of Vario Melody settings]

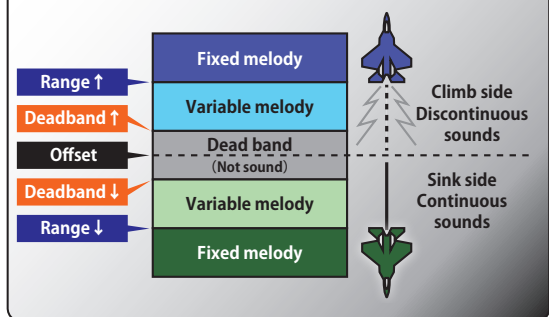



## Delay



The output vario melody does not change during the delay time. In other words, this is a minimum time of Vario melody output.

**Setting range :** 0.0 s, 0.5 s, 1.0 s, 1.5 s  
**Initial value :** 0.0 s

\*This parameter is effective to all variometers.

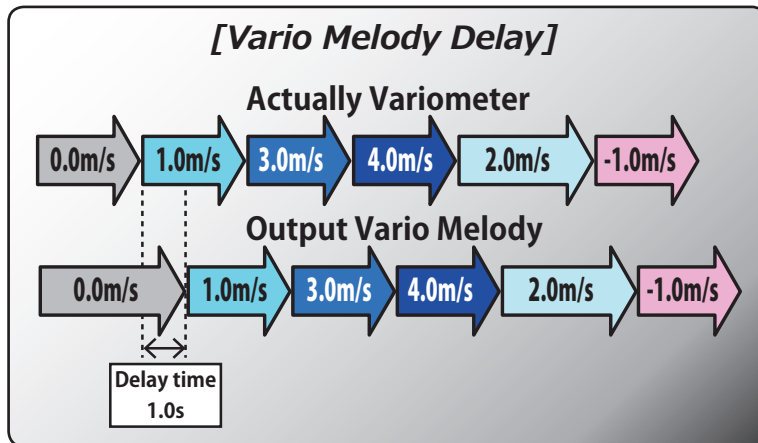



# Telemetry: Voltage [Battery]

In this screen, the battery voltage is displayed. In order to use this function, it is necessary to connect External voltage connector of R7008SB ⇔ SBS-01V ⇔ Battery

SBS-01V measures two batteries. The power battery connected to two lines is displayed on EXT-VOLT. The battery for receivers connected to 3P lines is displayed here.

- Tap the [Voltage] button in the Telemetry screen to call the setup screen shown below.

• Return to Linkage menu

Max. and min. values since the power was turned ON will display.



↓ The "down" arrow will indicate that an alarm will sound when the voltage drops to below the setting.

Alarm is chosen from Buzzer, Voice, and Inhibit.

Allows Speech to be turned ON or OFF.

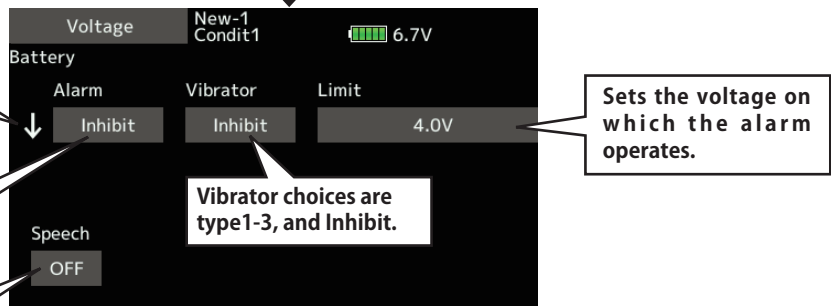

Displaying data from the receiver battery voltage  
 \*SBS-01V must be installed in the aircraft.  
 In this screen, the battery voltage of a receiver is displayed.

If it becomes higher or lower than the setting, an alarm and/or vibration will alert you.

- \*It cannot be used in FASST mode and S-FHSS mode.
- \*Only receiver voltage and EXT voltage can be used in FASSTest12CH mode.
- \*The FASSTest18CH /T-FHSS mode can use all the telemetry functions.

## < Two examples of wiring are shown >

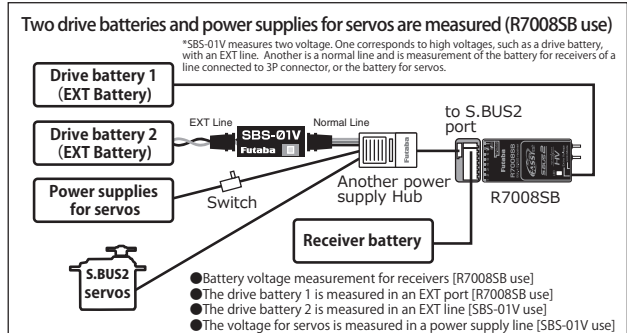
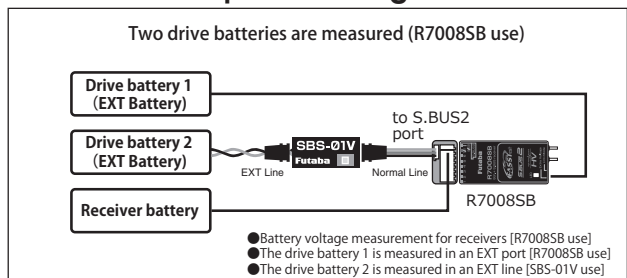

### Alarm set

1. Tap Alarm and choose from Buzzer, Voice, and Inhibit.
2. Choose "Inhibit" for Vibrator if not using the vibrator alarm. If using vibrator, choose one of the three types.
3. Tap to the Limit [4.0V] item .
4. Adjust the rate using the "▼▼" "▼" "▲" "▲▲" buttons.

Initial value: 4.0V

Adjustment range: 0.0V~100.0V

\*When the screen is tapped for one second, the rate is reset to the initial value.

5. To terminate the input and return to the original state, push the H/E button.

\*Refer to the manual of SBS-01V for the details of wiring.



# Telemetry: Voltage [Ext. battery]

Displaying data from the EXT battery voltage port

In this screen, the EXT battery voltage is displayed. In order to use this function, it is necessary to connect External voltage connector of R7008SB ⇔ SBS-01V ⇔ Battery

SBS-01V measures two batteries. The power battery connected to two lines is displayed on EXT-VOLT.

\*SBS-01V must be installed in the aircraft.

\*It cannot be used in FASST mode and S-FHSS mode.

\*Only receiver voltage and EXT voltage can be used in FASSTest12CH mode.

\*The FASSTest18CH /T-FHSS mode can use all the telemetry functions.

- Tap the [Voltage] button in the Telemetry screen to call the setup screen shown below.

•Return to Linkage menu

Max. and min. values since the power was turned ON will display.

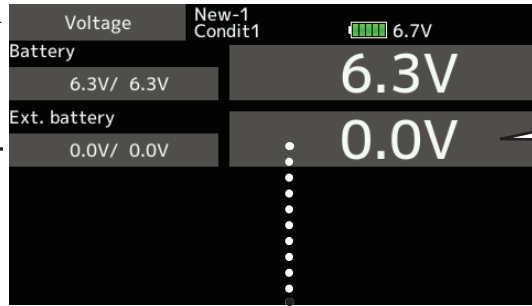

Ext. battery voltage

↓ The "down" arrow will indicate that an alarm will sound when the voltage drops to below the setting.

Alarm is chosen from Buzzer, Voice, and Inhibit.

Allows Speech to be turned ON or OFF.

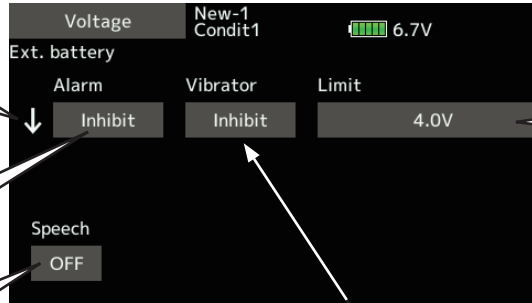

Sets the voltage on which the alarm operates.

### Alarm set

1. Tap Alarm and choose from Buzzer, Voice, and Inhibit.
2. Choose "Inhibit" for Vibrator if not using the vibrator alarm. If using vibrator, choose one of the three types.
3. Tap Limit [4.0V].
4. Adjust the rate using the "▼▼" "▼" "▲" "▲▲" buttons.  
Initial value: 4.0V  
Adjustment range: 0.0V~100.0V

\*When the screen is tapped for one second, the rate is reset to the initial value.

5. To terminate the input and return to the original state, push the H/E button.

**"Vibrator" type**  
If the following types are selected, the transmitter will vibrate during the warning.

Type 1

Type 2

Type 3



# Telemetry : GPS [Distance]

Displaying data from the Distance Screen

The Distance screen displays and sets altitude data from an SBS-01/02G GPS Sensor (sold separately), and allows the distance to the airborne aircraft to be read by the transmitter. When the aircraft flies inside or outside the set distance, an alarm and vibration alerts the pilot.

\*A GPS sensor must be installed in the aircraft.

\*The GPS sensor is necessary, and is sold separately. Mount and connect the sensor in accordance with the sensor instruction manual.

\*It cannot be used in FASST mode and S-FHSS mode.

\*Only receiver voltage and EXT voltage can be used in FASSTest12CH mode.

\*The FASSTest18CH /T-FHSS mode can use all the telemetry functions.

- Tap the [GPS] button in the Telemetry screen to call the setup screen shown below.

•Return to Linkage menu →

Max. and min. values since the power was turned ON will display.

↑ An upward arrow indicates the alarm will sound when the distance reaches above your set value.

↓ A downward arrow indicates the alarm will sound when the distance reaches below your set value.

Alarm is chosen from Buzzer, Voice, and Inhibit.

Allows Speech to be turned ON or OFF.

Tap to the [Preset] of "Reference" item. Sets the current aircraft position as the starting point.

Sets the distance on which the alarm operates.

### "Vibrator" type

If the following types are selected, the transmitter will vibrate during the warning.

Type 1 →

Type 2 → →

Type 3 → → → →

Altitude calculated as either straight line distance (slant) or surface distance on a map can also be selected.

Select <Slant> <Surface> to "Distance mode", tap the screen.



### **First, the set of a reference is required.**

1. The model and transmitter to which the GPS sensor was connected are turned on.
2. Tap to the [Preset] of "Reference" item.

\*Now, the position of the present model was set to 0 m.

### **Setting a "too far" alarm distance**

1. Tap Alarm and choose from Buzzer, Voice, and Inhibit.
2. Choose "Inhibit" for Vibrator if not using the vibrator alarm. If using vibrator, choose one of the three types.
3. Tap Limit [m].
4. Adjust the rate using the "▼▼" "▼" "▲" "▲▲" buttons.

Initial value: 1,000m

Adjustment range 0m~3,000m

(↑Limit ≥ ↓Limit)

\*When the screen is tapped for one second, the rate is reset to the initial value.

5. To terminate the input and return to the original state, push the H/E button.

### **Setting a "too close" alarm distance**

1. Tap Alarm and choose from Buzzer, Voice, and Inhibit.
2. Choose "Inhibit" for Vibrator if not using the vibrator alarm. If using vibrator, choose one of the three types.
3. Tap Limit [m].
4. Adjust the rate using the "▼▼" "▼" "▲" "▲▲" buttons.

Initial value: 0m

Adjustment range 0m~3,000m

(↑Limit ≥ ↓Limit)

\*When the screen is tapped for one second, the rate is reset to the initial value.

5. To terminate the input and return to the original state, push the H/E button.

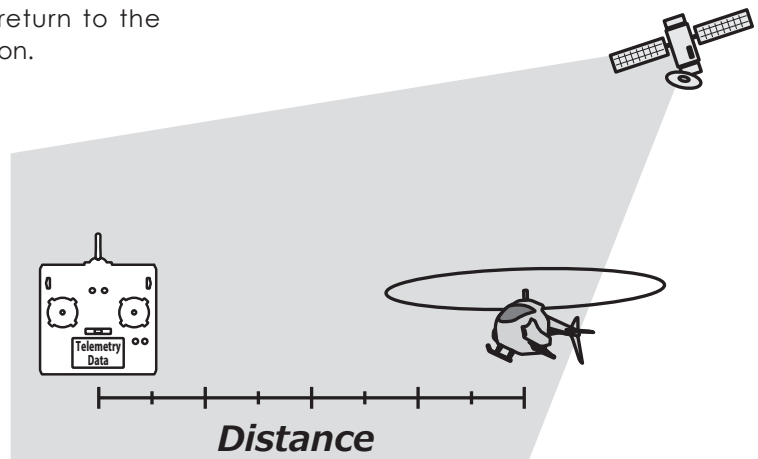

### **\*Positioning time of GPS**



When powered up, the SBS-01/02G begins to acquire GPS satellite data. This process can take several minutes. Please do not move the model during this process. During acquisition, the LED on the SBS-01/02G will blink green; after the satellite's signals have been acquired, the LED will become solid green, and the GPS signal strength display on the transmitter will show three bars.

Moving the model before the satellites are fully acquired will cause a delay in acquiring the satellite signal.



## Telemetry : GPS [Speed]

The speed screen displays and sets the speed data from an SBS-01/02G (GPS sensor) sold separately.

The speed of the aircraft during flight can be displayed. After flight, the maximum speed during flight can be viewed. Because this speed is based on position data from a GPS satellite, the ground speed is displayed instead of air speed. Consequently, with a head wind, the displayed speed decreases and with a tail wind, the displayed speed increases.

Displaying data from the speed

\*A GPS sensor must be installed in the aircraft.

\*The GPS sensor is necessary, and is sold separately. Mount and connect the sensor in accordance with the sensor instruction manual.

\*It cannot be used in FASST mode and S-FHSS mode.

\*Only receiver voltage and EXT voltage can be used in FASSTest12CH mode.

\*The FASSTest18CH /T-FHSS mode can use all the telemetry functions.

- Tap the [GPS] button in the Telemetry screen to call the setup screen shown below.

•Return to Linkage menu →

**Max. and min. values since the power was turned ON will display.**

↑ An upward arrow indicates the alarm will sound when the speed reaches above your set value.

↓ A downward arrow indicates the alarm will sound when the speed reaches below your set value.

Alarm is chosen from Buzzer, Voice, and Inhibit.

Allows Speech to be turned ON or OFF.

Reference and Distance mode work in conjunction with Distance discussed on the previous two pages.

Sets the speed on which the alarm operates.

### Alarm setting when speed increases

1. Tap Alarm and choose from Buzzer, Voice, and Inhibit.
2. Choose "Inhibit" for Vibrator if not using the vibrator alarm. If using vibrator, choose one of the three types.
3. Tap Limit [xxx km/h].
4. Adjust the rate using the "▼▼" "▼" "▲" "▲▲" buttons.  
Initial value: ↑200km/h ↓0km/h  
Adjustment range 0km/h~500km/h  
(↑Limit ≥ ↓Limit)  
\*When the screen is tapped for one second, the rate is reset to the initial value.
5. To terminate the input and return to the original state, push the H/E button.

### "Vibrator" type

If the following types are selected, the transmitter will vibrate during the warning.

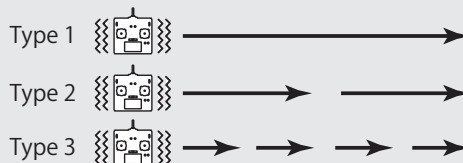

### \*Speed alarm precaution

Since the GPS speed sensor displays the ground speed, it cannot be used as a stall alarm. For example, an aircraft that stalls at 50km/h will stall if the tailwind is 5km/h or greater even through 55km/h is displayed by ground speed. In addition, with an aircraft that will disintegrate in midflight at 400km/h at an over-speed alarm, when the headwind reaches 30km/h the airplane will disintegrate in midair due to over speeding even at a ground speed of 370km/h.



# Telemetry : GPS [Altitude, Variometer, Position]

\*A GPS sensor must be installed in the aircraft.

The Altitude, Variometer, Position screen displays and sets the data from an SBS-01/02G (GPS sensor) sold separately.

\*It cannot be used in FASST mode and S-FHSS mode.

\*Only receiver voltage and EXT voltage can be used in FASSTest12CH mode.

\*The FASSTest18CH /T-FHSS mode can use all the telemetry functions.

\*The GPS sensor is necessary, and is sold separately. Mount and connect the sensor in accordance with the sensor instruction manual.

- Select [GPS] in the Telemetry screen and access the setup screen shown below.

•Return to Linkage menu →

Max. and min. values since the power was turned ON will display.

Refer to the former page for a setup about Altitude and Variometer.

This indicates the receiving accuracy from a GPS Satellite. When three bars are displayed, the GPS is ready for use.

The position of the present model is displayed.

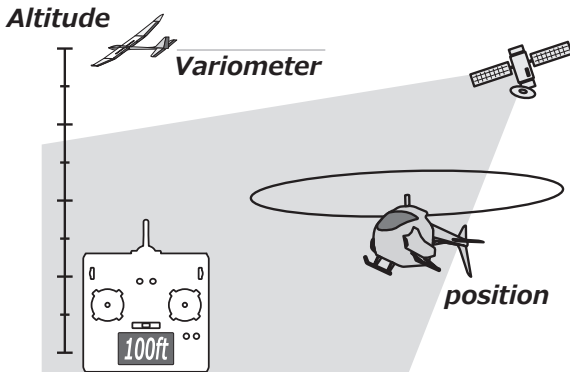





# Telemetry : Servo sensor [Current]

The SBS-01S can monitor and display the in-flight current, operating angle, and internal temperature of up to two S.BUS2 servos.

\*Servo sensor must be installed in the aircraft.

If you forget to connect the servo wiring during fuselage assembly, or the servo was disconnected, an alarm can be activated at the transmitter.

- Select [Servo sensor] in the Telemetry screen and access the setup screen shown below.

- Return to Linkage menu

Tap here and go to the Servo 2 settings page. (Display and settings content is the same as Servo 1.)

Max. and min. values since the power was turned ON will display.

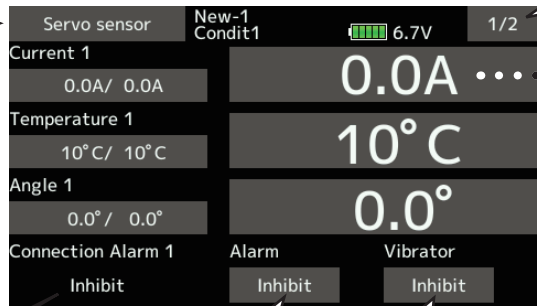

Tapping this will take you to the settings screen for the current alarm

Tapping this and selecting "Buzzer" will cause the device to sound an alarm when servos are not connected.

Tapping this and selecting "Each type" will cause the device to vibrate when servos are not connected.

When the Alarm or Vibrator options are activated, the servo connection will display.

Connection Alarm 1	Connected
Connection Alarm 1	Not Connected

\*This alarm and display is limited to the S.BUS servos connected to the servo sensors.

↑ An upward arrow indicates the alarm will sound when the current reaches above your set value.

↓ A downward arrow indicates the alarm will sound when the current reaches below your set value.

Alarm is chosen from Buzzer, Voice, and Inhibit.

Allows Speech to be turned ON or OFF.

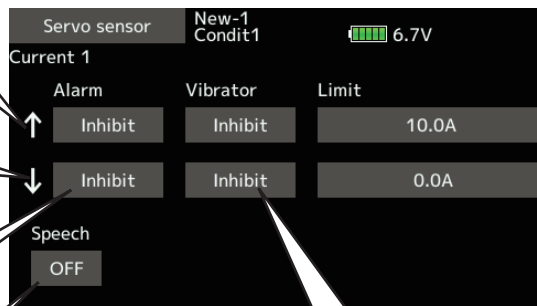

Sets the current on which the alarm operates.

Vibrator is choices are type1-3, and Inhibit.

Initial value: ↑ 10.0A ↓ 0.0A  
Adjustment range 0.0A~10.0A  
( ↑ Limit ≥ ↓ Limit)



# Telemetry : Servo sensor [Temperature] [Angle]

\*Servo sensor must be installed in the aircraft.

- Select [Servo sensor] in the Telemetry screen and access the setup screen shown below.

•Return to Linkage menu →

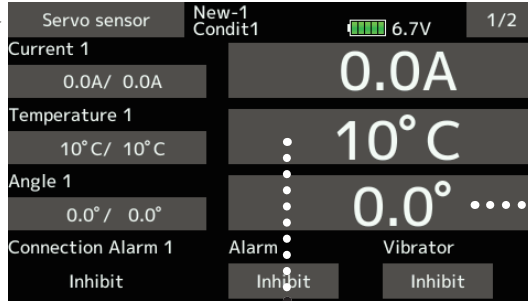

● Temperature

↑ An upward arrow indicates the alarm will sound when the temperature reaches above your set value.

↓ A downward arrow indicates the alarm will sound when the temperature reaches below your set value.

Alarm is chosen from Buzzer, Voice, and Inhibit.

Allows Speech to be turned ON or OFF.

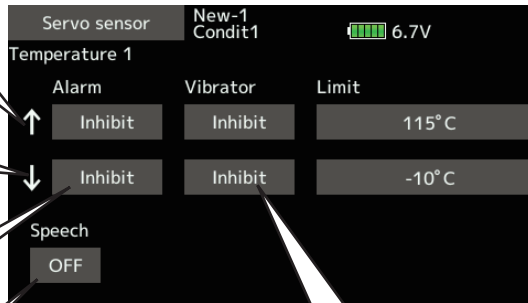

Sets the temperature on which the alarm operates.

Vibrator choices are type1-3, and Inhibit.

Initial value: ↑ 115°C ↓ -10°C  
Adjustment range -10°C ~115°C  
( ↑ Limit ≥ ↓ Limit)

● Angle

↑ An upward arrow indicates the alarm will sound when the angle reaches above your set value.

↓ A downward arrow indicates the alarm will sound when the angle reaches below your set value.

Alarm is chosen from Buzzer, Voice, and Inhibit.

Allows Speech to be turned ON or OFF.



Sets the angle on which the alarm operates.

Vibrator choices are type1-3, and Inhibit.

Initial value: ↑ +180.0° ↓ -180.0°  
Adjustment range -180.0° ~ +180.0°  
( ↑ Limit ≥ ↓ Limit)



## Telemetry : Current sensor [Current]

The SBS-01C has the capability of measuring current, voltage and capacity (consumption) from drive battery all at the same time.

\*Current sensor must be installed in the aircraft.

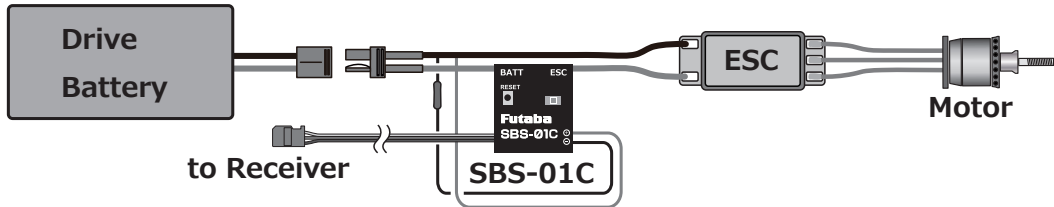

- Select [Current] in the Telemetry screen and access the setup screen shown below.

- Return to Linkage menu

Max. and min. values since the power was turned ON will display.

The consumption capacity is indicated. It isn't the present battery capacity.

### ◆ Alarm setting

↑ An upward arrow indicates the alarm will sound when the current reaches above your set value.

↓ A downward arrow indicates the alarm will sound when the current reaches below your set value.

Allows Speech to be turned ON or OFF.

### "Vibrator" type

If the following types are selected, the transmitter will vibrate during the warning.



# Tele. setting

Speech interval set , data logging of telemetry.

Set the speech interval of telemetry data, and the logging of telemetry data to an SD card at chosen intervals.

Telemetry data can be checked on your PC after a flight.

- Tap the [Tele.setting] button in the Linkage menu to call the setup screen shown below.

- Return to Linkage menu

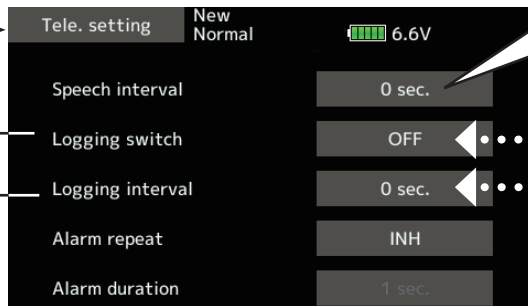

Sets the speech interval  
Initial value: 0 sec.  
Adjustment range 0-30 sec.

## Telemetry data log function

Telemetry data has been adapted to the log function which is recorded at the SD card.

### [Setting method]

- ① Open the linkage menu Tele. setting screen.
- ② Log recording can be started and stopped by operating a switch. The Logging switch is selected.
- ③ The log output interval can be set.

\* The data to be recorded is updated at the time set by Linkage menu → System Type screen D/L interval. For example, when the log output interval is 1 second and the D/L interval is 2 seconds the same data is overlapped and recorded twice.

### [Operation method]

- ① Insert the SD card into the card slot.
- ② Set the switch set by Log Start/Stop Switch to ON. A beep sounds and a log file is created and recording of the telemetry data begins.

**Absolutely never remove the SD card while log data is being recorded.**

- ③ Set the switch set by Logging switch to OFF. A beeping sound is generated and recording of the telemetry data stops.
- ④ Turn off the transmitter power and remove the SD card.

#### ■ Log file

A log file is created in the SD card LOG folder. Two files with the same filename, but a different extension are created. (Example: 00001234.FLI, 00001234.FLD)

■ Extension FLI: Slot allocation information file

■ Extension FLD: Log data file

\*When copying or moving a log file, always select both the .FLI file and .FLD file.

Log files can be converted to CSV format by using the telemetry log converter available at the Futaba website.

#### ■ Notes

- ◇ Altimeter altitude data and GPS distance and altitude data output with the point that time logging started as the reference (0m). When the transmitter preset position and the log start position are different, the transmitter display and the log data display will also be different. The altitude and distance from the take-off position can be recorded by starting logging immediately after take-off.
- ◇ The transmitter gear ratio or number of fins setting is not reflected in the speedometer log data (speed). Multiply the gear ratio or number of fins by the speed data.
- ◇ When the SD card becomes full, recording stops and does not resume even if logging is restarted.



## Telemetry Alarm Duration and Repeat time

The repeat time and duration time for the telemetry alarm (buzzer, vibration and speech) can be set.

- Tap the [Telemetry Setting] button in the Linkage menu to call the setup screen shown below.

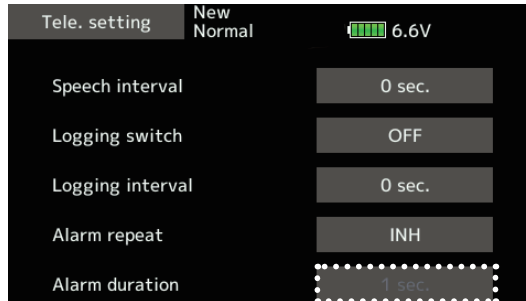

Duration is not displayed when Repeat is INH.

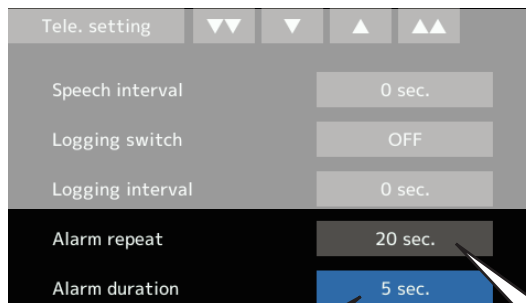

### Duration

It is an alarm output time.

**Setting range :** 1 s ~ 30 s

**Initial value :** INH

Duration value has to be less than repeat value.

Duration time is extended when the other alarm event occurs.

### Repeat

It is a repeat time of an alarm output.

**Setting range :** INH, 1 s ~ 240 s

**Initial value :** INH

### [Duration and Repeat time for Telemetry Alarm]

e.g. Repeat time is 8 seconds and Duration time is 5 seconds.

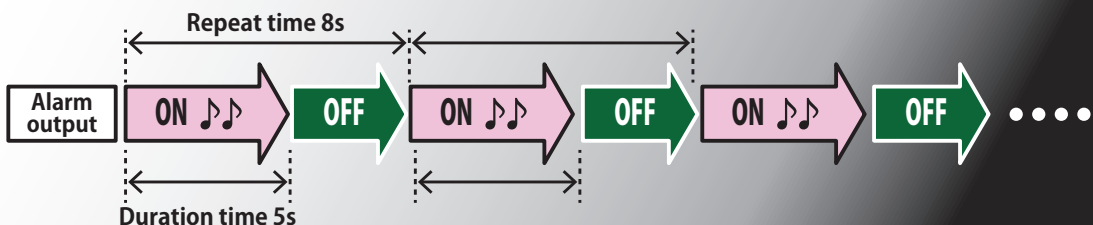



# Trainer

## Trainer system starting and setting

FX-36 trainer system makes it possible for the instructor to choose which channels and operation modes can be used in the student's transmitter. The function and rate of each channel can be set. The training method can also be matched to the student's skill level. Two transmitters must be connected by an optional Trainer Cord, and the Instructor's transmitter should be programmed for trainer operation, as described below.

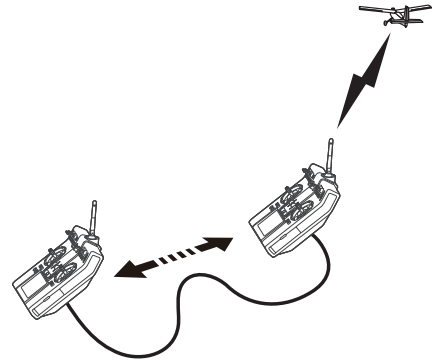

When the Instructor activates the trainer switch, the student has control of the aircraft (if MIX/FUNC/NORM mode is turned on, the Instructor can make corrections while the student has control). When the switch is released the Instructor regains control. This is very useful if the student gets the aircraft into an undesirable situation.

- Setting data are stored to model data.
- Student rate can be adjusted at MIX/FUNC/NORM mode.
- Activated student channels can be selected by switches.

**Note:** This trainer system can be used in the following manner:

1. With the FX-36 transmitter and a conventional transmitter, if the channel order is different, it is necessary to match the channel order before using this function.  
You can select the channel of input data from student's transmitter in the "FUNC" or "MIX" mode.
2. When the FX-36 is used as the instructor's transmitter, set the modulation mode of the student's transmitter to PPM.

If being used as the student, FX-36 can be connected to the instructor's transmitter which requires the student's mode to be PPM. FX-36 always sends PPM mode signal from the trainer jack.

(In the case of student's transmitters other than 2.4 GHz)

3. Be sure that all channels work correctly in both transmitters before flying.

### Corresponding types of transmitters and trainer mode settings:

Types of transmitters		Instructor's transmitter settings		Student's transmitter settings			Trainer Cords
Instructor	Student	System Type Mod. mode	Trainer setting CH mode	System Type Mod. mode	Trainer setting CH mode	Mod. mode	
FX-36,FX-32 T14SG,T16SZ,T18SZ T18MZ	FX-36,FX-32 T14SG,T16SZ,T18SZ T18MZ	Arbitrary	16CH	Arbitrary	16CH	-	T12FG (FUTM4405) and 9C (FUTM4415) Trainer Cords
FX-36	T14MZ, FX-40, T12Z, T12FG, FX-30	Arbitrary	12CH	PCM-G3 2.4G	12CH	PPM	
FX-36	T8FG, FX-20	Arbitrary	12CH 8CH	FASST-MLT2 FASST-MULT	-	-	T12FG (FUTM4405)
FX-36	T10C, T9C, T7C,T6EX, T4EX	Arbitrary	8CH	PPM	-	-	
FX-36	T10CG,T7C	Arbitrary	8CH	Arbitrary	-	-	T12FG (FUTM4405)
FX-36	T10J, T8J, T6K, T6J, T6L	Arbitrary	8CH	Arbitrary	-	-	T12FG (FUTM4405) and 9C (FUTM4415) Trainer Cords
T14MZ, FX-40, T12Z, T12FG, FX-30	FX-36	Arbitrary	12CH	Arbitrary	12CH	-	
T8FG, FX-20	FX-36	Arbitrary	12CH	Arbitrary	12CH	-	
T10C, T10CG, T10J, T9C, T7C T7C, T8J, T6K T6J	FX-36	Arbitrary	-	Arbitrary	8CH	-	



- Tap the [Trainer] button in the Linkage menu to call the setup screen shown below.

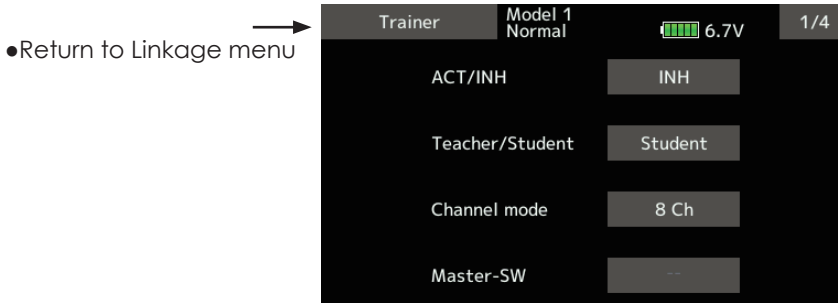

### When using at the student side

#### 1. Select the mode.

\*When changing the mode, tap to the item you want to change and change the mode using the "▼▼" "▼" "▲" "▲▲" buttons. The display blinks. Tap the screen to change the mode.

"Teacher/Student": Select [Student].

"ACT/INH": Enable operation by changing to [ACT].

"16/12/8 CH": When the student uses the FX-36, T14SG, T18SZ, T16SZ, T18MZ, select [16CH]. When the student uses the T14MZ, T12Z, T12FG or FX-40, select [12CH]. Otherwise select [8CH].

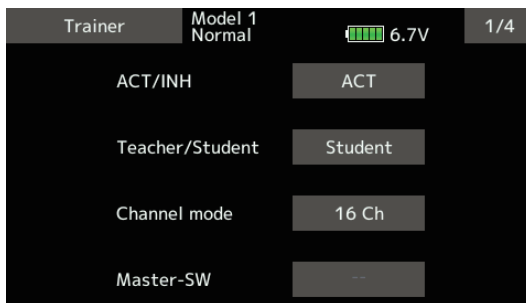

Note: In "student mode", only the teacher side can turn on and off the power to the student's transmitter. Keep the power switch always at off position.

### When using at the teacher side

#### 1. Select the mode.

\*When changing the mode, tap to the item you want to change and change the mode using the "▼▼" "▼" "▲" "▲▲" buttons. The display blinks. Tap the screen to change the mode.

"Teacher/Student": Select [Teacher].

"ACT/INH": Enable operation by changing to [OFF] or [ON].

"16/12/8 CHANNEL": When the student uses the FX-36 (including the T18MZ, T18SZ, T16SZ, T14SG) select [16CH]. Otherwise select [12CH] or [8CH].

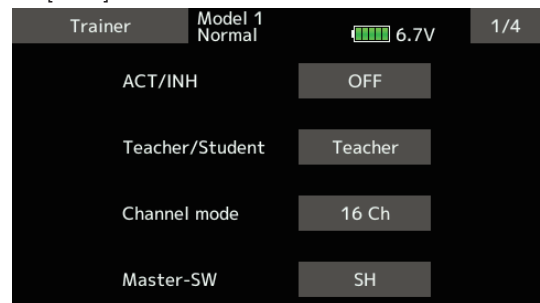

#### 2. Select the trainer switch.

\*When setting or changing the switch, tap to the "SWITCH" item, call the switch setup screen and set the desired switch and ON/OFF direction.

(See "Switch selection method" at the end of this manual for selection method details.)

\*The switch mode can also be selected when setting the ON position on the switch setup screen. When [Normal] is selected, normal ON/OFF operation is performed. When [Alternate] is selected, the trainer function is alternately turned on and off each time the switch is operated. This allows alternate ON/OFF switching even when a momentary switch (SH) is used.

Note: The trainer function won't be turned on unless the Instructor's transmitter receives signals from the student's transmitter. Be sure to confirm this after connecting your trainer cable.



### 3. Select the operating mode for each channel.

Trainer	Model 1 Normal	6.7V	2/4
Ch Function	Mode	Switch	Rate
1 Aileron	FUNC	--	100
2 Elevator	OFF		
3 Throttle	OFF		
4 Rudder	OFF		
5 Gyro	OFF		
6 Pitch	OFF		

"NORM": The model is controlled by signals from the student transmitter.

"MIX" mode: The model is controlled by signals from the teacher and student transmitters. (Reset the student's model data to the default condition.)

"FUNC" mode (function mode):

The model is controlled by signals from the student transmitter with the teacher AFR setting. (Reset the student's model data to the default condition.)

"OFF": Only the teacher side operates.

\*The setting above allows setting of the servo throw relative to the amount of student side operation when [MIX] or [FUNC] was selected.

When changing the rate, use the "▼▼" "▼" "▲" "▲▲" button to Tap the [Rate] item of the channel.

Setting range: -100~+100

Initial value: +100

\*When the value is tapped, the rate is reset to the initial value.

### 4. Set the switch of each channel.

\*When setting the switch at each channel, tap to the "SW" item of the channel you want to change, call the switch setup screen, and select the switch.

"--" : Always ON.

"SA"~"SH": The switch which enables student side operation can be selected. (See "Switch selection method" at the end of this manual for selection method details.)

### Trainer student channel setting function

In training mode, the instructor's transmitter can pick up the student's signal on both the "Function" and "Mix" channels. That makes it easy for the two transmitters to connect even if the student and instructor have set up their transmitters differently.

\*When the instructor's transmitter mode is set to "NORM", the signal of the same channel of the student's transmitter is output as is. (The same as before.)

Trainer	Model 1 Normal	6.7V	2/4
Ch Function	Mode	Switch	Rate
1 Aileron	FUNC	--	100
2 Elevator	OFF		
3 Throttle	OFF		
4 Rudder	OFF		
5 Gyro	OFF		
6 Pitch	OFF		

Trainer	Model 1 Normal	6.7V	2/4
Ch Function	Mode	Switch	Rate
1 Aileron	FUNC	--	100
2 Elevator	OFF		
3 Throttle	OFF		
4 Rudder	OFF		
5 Gyro	OFF		
6 Pitch	OFF		





# Warning setting

Mixing warning normal reset

The warning display at power ON can be turned ON/OFF for each function. Use by setting functions which may be dangerous if operated at power ON to ON. Initial setting is all ON (Buzzer).

- Tap the [Warning setting] button in the Linkage menu to call the setup screen shown below.

- Return to Linkage menu

Warning setting	Model 1 Normal	
	Alarm	Vibrator
Condition	Buzzer	Inhibit
Throttle cut	Buzzer	Inhibit
Idle down	Buzzer	Inhibit
Throttle position	Buzzer	Inhibit
Motor	Buzzer	Inhibit
Throttle hold	Buzzer	Inhibit

The settings can be changed individually. When set to [Inhibit], a warning is not displayed at power ON.

### "Vibrator" type

If the following types are selected, the transmitter will vibrate during the warning.

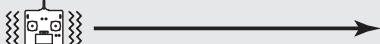
Type 1 

Type 2 

Type 3 

**⚠ WARNING**

**! It is extremely dangerous to unnecessarily inhibit essential warnings.**

- Careless spinning of propellers or rotors poses a danger of serious injury or death.



# User menu setting

Original menu screen making

FX-36 has a menu for each of the following: System, Linkage, and Model. Also, you can create a personalized User menu that can include all of the menus that you use most often.

\*Any change made to data entered from the User menu or from the normal method of use are the same. Changes made in either way are saved into the transmitter memory.

- Tap the [User menu setting] button in the Linkage menu to call the setup screen shown below.

- Return to Linkage menu

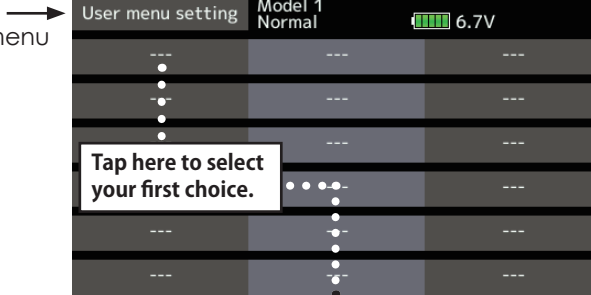

Once pressed, 3 pages of choices will be displayed.

User menu select	Model 1 Normal	6.7V	1/3
Display	Sound volume	Date and Time	
Calibration	Battery	Range check	
S.Bus servo	Information	Servo monitor	
Model select	Model type	Servo reverse	
End point	Servo speed	Sub-trim	
Function	Fail safe	System type	

When "----" is chosen, it can be deleted.

Make your selection, press your choice and the first of your "User menu" will be entered.

## How to call a User menu

1. From the home screen, press the U/M button.

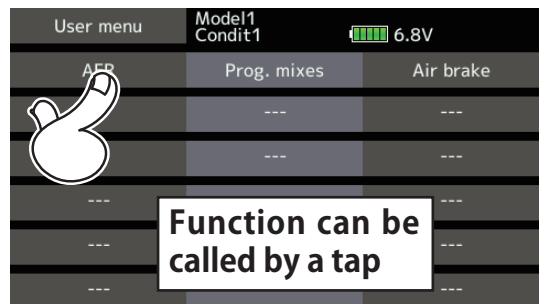
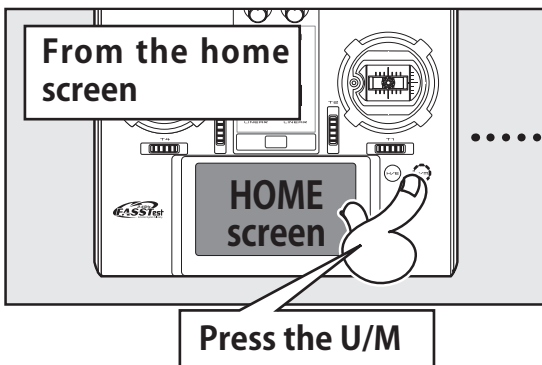



## Data reset

Model memory setting data reset. (by item)

This function is designed to allow you to reset selected portions or all of the settings saved in the active model memory. You may individually choose to reset the following sets of data:

### Trim (All condition):

Reset the digital trim setting.

\*All the conditions, or the condition currently being displayed (the entire group for group setting), can be selected.

\*The trim step amount and trim rate are not reset.

### Trim (Current and Group condition):

Reset the digital trim setting.

\*Current condition, group condition, can be selected.

\*The trim step amount and trim rate are not reset.

- Select [Data reset] at the linkage menu and call the setup screen shown below.

- Return to Linkage menu

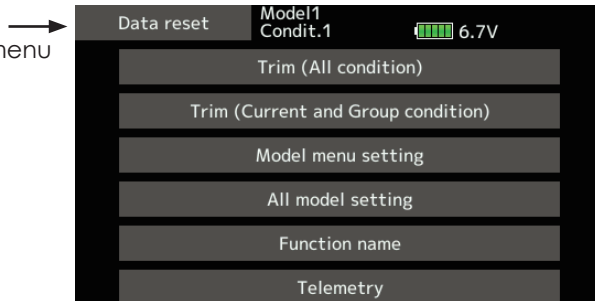

### Data resetting method

1. Tap to the item you want to reset and tap the screen.

\*A confirmation message appears.

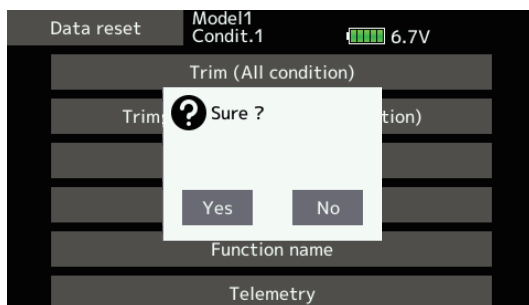

2. Execute reset by tapping the "Yes".

### Model menu setting:

Resets all the functions in the Model menu except condition select.

### All model setting:

Resets all Linkage and Model menu functions except for frequency, model select, and model type.

### Function Name:

A function name is reset.

### Telemetry:

Reset the telemetry setting.

[Trim (All condition)]: Resets only the Trim (all conditions)

[Trim(Current and Group condition)]: Resets only the data of Trim (condition in use and all the conditions set to group mode)

[Model menu setting]: Resets all the functions in the model menu, except the condition selection functions.

[All model setting]: Resets all the functions in the linkage menu and model menu except the frequency, model select, and model type functions.

[Function name]: Resets only the function name functions.

[Telemetry]: Resets only the telemetry functions.

### ⚠ CAUTION

⊘ **Never engage the Data reset function while the engine is starting or the motor drive wiring is connected.**

■ Sudden, abrupt spinning of propellers or rotors is extremely dangerous.

### ⚠ CAUTION

#### ❗ Throttle Reverse

■ Only the throttle channel (CH3) initial setting is REV (reverse). Thoroughly check the Hi and Low directions of the engine or motor used and be careful that they do not suddenly run at full speed. Even after data reset, CH3 is reversed.



## MODEL MENU (Common functions)

This section describes the AFR, program mixing, and other functions common to all model types.

Before setting the model data, use the Model Type function of the Linkage menu to select the model type matched to the fuselage. When another model type is selected thereafter, the AFR, program mixing, and other setting data are reset.

The functions in the Model menu can be set for each flight condition. When you want to use the system by switching the settings for each condition by switch, stick position, etc., use the Condition

Select function to add flight conditions. (Up to 8 conditions can be used)

Note: The FX-36 is designed so that the airplane and glider model types are compatible with aircraft of similar type wings.

This section outlines the relationship between the functions common to airplanes and gliders, except some dedicated functions, and model type.

The setting items depend on the number of servos and other differences according to the wing type used, but reread them. The setup screens in the instruction manual are typical examples.

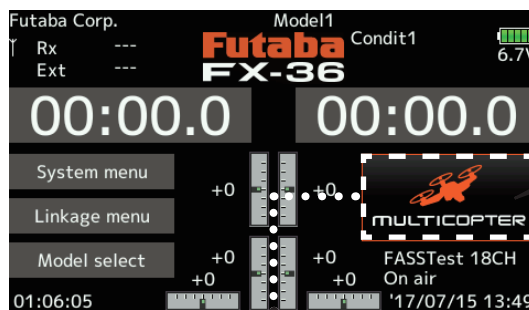

Tap this icon to go to the model menu.

- Select the function name and return to the Home screen.

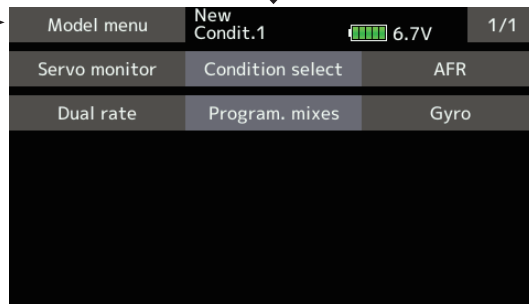

(Model menu screen example)

\*The Model menu screen depends on the model type.

### Model menu (Common functions) functions table

[Servo monitor]: Displays the servo test and operation position→**Linkage menu referring**

[Condition select]: Flight conditions addition, deletion, copy, condition renaming, and condition delay can be set.

[AFR]: Sets the angle and curve of all the operation functions.

[Dual rate]: D/R curve which can be switched with a switch, etc. can also be added.

[Program. mixes]: Program mixing which can be freely customized. Up to 10 mixes can be used for each condition.



## Condition select

Flight condition's addition, deletion, copy, condition renaming, and condition delay can be set. [All model types]

The functions in the Model menu can be used by switching the settings of up to 8 flight conditions by using the Condition select function to add flight conditions. Add conditions, as required.

When you do not want to use the Condition select function, this setting is unnecessary. In this case, use the flight conditions assigned at initial setting.

- Since switching by stick and lever position, in addition to ordinary toggle switch, is possible as the flight condition selector switch, this function can be linked with other operations.
  - A Condition Delay function can be set. Unnecessary fuselage motion generated when there are sudden changes in the servo positions and when there are variations in the operating time between channels during condition switching can be suppressed. The delay can be set for each channel.
  - When multiple conditions were set, their operation priority can be freely changed.
  - The condition name can be changed. The selected condition name is displayed on the screen. When a condition has been added, give it a name which can be easily confirmed.
- Select [Condition select] at the model menu and call the setup screen shown below.

**Condition select** Model1 Condit1 6.7V

1 Condit1 Add

2

3

4

5 Rename

6 Copy

7

8 Delay

**Conditions List**

**Currently selected condition name**

**Condition Renaming**

1. Select the condition by tapping the condition you want to rename in Conditions List.
2. Tap the [Rename] button.
3. Enter the new name from the keyboard which appears on the screen.
4. When the keyboard [Condition name] key is tapped, the new name is registered.

**Condition Addition**

1. When the [Add] button is tapped, the Condition Select screen appears.  
\*Only the number of buttons corresponding to the conditions which can be added are displayed.
2. Select the desired conditions by tapping the buttons.  
\*The selected conditions are added to Conditions List.
3. Tap the [--] button to call the <Switch> screen.
4. Select the switch to be used in condition switching.  
(See "Switch selection method" at the end of this manual for selection method details.)
5. The "Condition1" data for the added conditions is copied.



**Currently selected condition name**

Condition select    Model1  
 Condit1    6.7V

1	Condit1		Add
2	Condit2	--	
3			Remove ●●●
4			Rename
5			
6			Copy ●●●
7			
8			Delay ●●●

**Conditions List**

**The ON/OFF switch of condition is chosen.**

### Condition Copy

1. Tap the [Copy] button. The Copy screen appears.
2. Select the condition by tapping the button of the copy source conditions.
3. Next, select the condition by tapping the copy destination condition.
4. Tap the [Copy] button.
5. When the [Yes] button is tapped, the data is copied. (To abort copying, tap the [No] button.)

### Condition Remove

1. Select the condition by tapping the condition you want to reset in Conditions List.
2. Tap the [Remove] button.
3. When the [Yes] button is tapped, the condition is reset. (To abort resetting, tap the [No] button.)

Condition select    Model1  
 Condit1    6.8V

1	Condit1		Add
2	Condit2	--	
3	Condit3	--	Remove
4	Condit4	--	
5			Rename
6			Copy
7			Delay ●●●
8			

**Last condition has the highest priority**

● **Group/single mode switching (Gr./Sngl)**  
 (For a description of the operation method, see the description at the back of this manual.)

### Priority change

1. Tap the condition whose priority you want to change in Conditions List.
2. Change the priority with the priority [△] or [▽] button. (The last condition has the highest priority.)

\*The initial setting condition cannot be moved. It has the lowest priority.

Condition select    Model1  
 Condit1    6.7V    1/3

Ch	Function	Delay	
1	Aileron	0	Gr.
2	Elevator	0	Gr.
3	Throttle	0	Gr.
4	Rudder	0	Gr.
5	Gyro	0	Gr.
6	Gyro2	0	Gr.

### Condition delay setting

1. Switch to the condition you want to set.
2. Tap the Delay button of the channel you want to set.
3. Use the value input buttons to set the delay.
  - Initial value: 0
  - Adjustment range: 0~27 (maximum delay)



# AFR

The angle and curve of each operation function can be set. [All model types]

AFR function is used to adjust the throw and operation curve of the stick, lever, and switch functions for each flight condition.

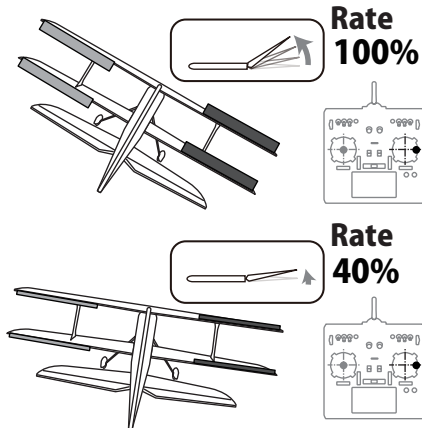

This is normally used after End Point has defined the maximum throw. When mixing is applied from one channel to another channel, both channels can be adjusted at the same time by adjusting the operation rate through the AFR function.

- Operation curve adjustment: Three types of curves (EXP1, EXP2, and Point) can be selected. A maximum 17 points curve can be used for the point curve type. (Initial setting: 9 points) The number of points can also be increased and decreased and curves from complex curves to simple curves can be used.
- Operation speed adjustment: The operation speed of each function when the function is operated (including at flight condition switching) can be adjusted. The function operates smoothly at a constant speed corresponding to the set speed.

When D/R is turned ON, the display will show "D/R----", and the rudder angle (rate) and EXP can be set when D/R is ON.

- Select [AFR] at the model menu and call the setup screen shown below.

• Return to Model menu

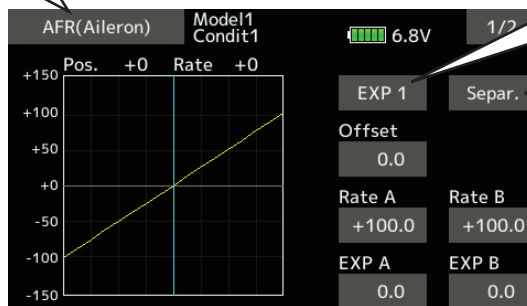

Curve select  
EXP1, EXP2, Point curve

Curve select  
Separately ⇔ Combination  
(Left and right symmetrical curve.)

Left/right, Up/down, overall adjustment at Rate A and Rate B

• Operation curve setting  
(For a description of the setting method, see the description at the back of this manual.)

**Function selection**

1. When the function select button is tapped, a selection screen appears.
2. Select the function you want to set at the selection screen.

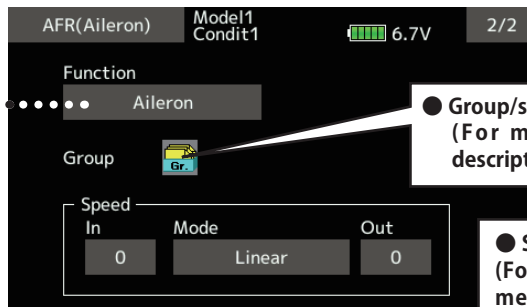

• Group/single mode switch (Gr./Sngl)  
(For more information, see the description at the back of this manual.)

• Servo speed setting  
(For a description of the setting method, see the description at the back of this manual.)



## Dual rate

D/R curves which can be switched by switch, etc. can be added. The curve can be adjusted by the AFR function.

- Up to 6 rates can be added for each condition.
- D/R is set for each condition and is not reflected at other conditions.
- D/R at the top of the D/R list has priority.

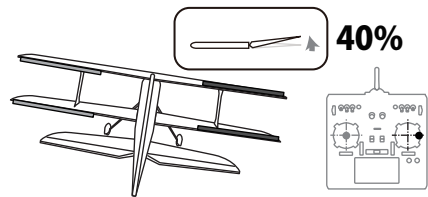
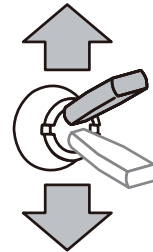
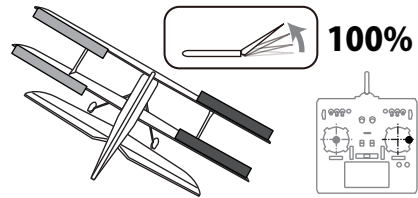

- Select [Dual rate] at the model menu and call the setup screen shown below.

- Return to Model menu

Dual rate	Status	Function	Switch
1 D/R 1	INH	Aileron	SD
2 D/R 2	INH	Elevator	SA
3 D/R 3	INH	Rudder	SB
4 D/R 4	INH	Aileron	--
5 D/R 5	INH	Aileron	--
6 D/R 6	INH	Aileron	--

The ON/OFF switch of dual rate is chosen.

Activate the D/R function by tapping the [INH].

When the function select button is tapped, a selection screen appears. Select the function you want to set at the selection screen.

**Rate, EXP settings are on AFR function**

- Setting rudder angle, EXP  
On this D/R screen you can set functions and switchover switches. Rudder angle (rate) and EXP settings are performed on the AFR screen when the D/R switch is ON.





# Program. mixes

Program mixing which can be freely customized. Up to 10 mixings can be used for each condition. [All model types]

Programmable mixing may be used to correct undesired tendencies of the aircraft, and it may also be used for unusual control configurations. Mixing means that the motion of a command channel, called the "master," is added to the motion of the mixed channel, called "slave."

You may choose to have the Masters trim added to the Slave channel response, if you desire ("Trim" setting). The mixing curve can be changed so that the undesired tendencies can be corrected effectively by setting the EXP1/EXP2/Point modes.

Offset-type mixing applies a fixed offset or preset to the programmed channel servo operation and may control up to four circuits simultaneously.

The Programmable mixing includes a powerful link function, which allows Programmable mixing to be linked with the special mixing functions, or with other programmable mixing functions. The link function can be set up for Master and Slave channel individually.

- Tap the [Prog. mixes] button in the Model menu to call the setup screen shown below.

- Return to Model menu



● Group/single mode switch (Gr./Sngl)  
(For more information, see the description at the back of this manual.)

After this function is activated, the master and slave function names (or offset mixing) are displayed.

Mixing/Offset mode switch



● Operation curve setting  
(For a description of the setting method, see the description at the back of this manual.)

Activate the function by tapping the [INH].

The ON/OFF switch of prog. mixes is chosen.

Master function (or Stick, Switch, Dial) is chosen.

Slave function is chosen.

Servo speed setting

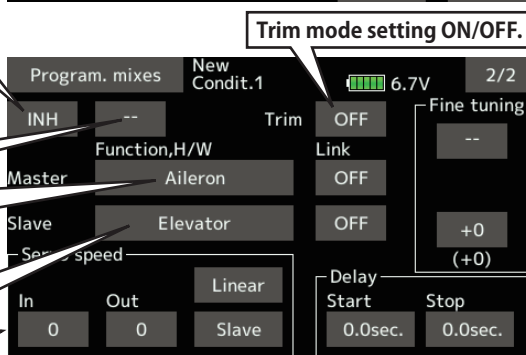

Trim mode setting ON/OFF.

Fine tuning trim setting

The on time (start/stop time) can be set up to 4 seconds. It is useful for landing gear control of the jet or scale plane, etc.



## Setting methods

### ●Group/single mode selection

Activating functions for only the selected conditions:

1. Tap the [Gr] button and switch to the [Sngl] mode.

\*Each time the button is tapped, it toggles between the Gr and Sngl modes.

### ●Mixing mode selection

Using the offset mode:

1. Tap the Mode button and switch to the Offset mode.

\*Each time the button is tapped, it toggles between the Mixing and Offset modes.

### ●Mixing setup screen selection

1. Tap the button of the mixing you want to set. The mixing setup screen is displayed. Activate the function.

2. Activate the function by tapping the [INH] button.

\*Each time this button is tapped, it toggles between [INH] and [ON/OFF].

### ●Mixing ON/OFF switch setting and ON/OFF direction switching

\*An ON/OFF switch is not set even when the function is activated.

1. When you want to turn mixing ON/OFF by switch, tap the [--] button to call the <Switch> screen and then select the switch and its ON direction.

\*For a description of the selection method, see [Switch setting method] at the back of this manual.

### ●Master channel setting (except offset type mixing)

1. Tap the Master button to call the Function menu and select the master channel.

2. To link this mixing with other mixing, tap the "Link" button.

\*Each time the button is tapped, it toggles between mixing direction + and - and "OFF" (no link).

\*Master channel control can be set to stick, VR, and other simple travels which do not include End point, AFR, D/R, mixing setting, etc. In this case, display the <Function,H/W> screen by tapping the [Stick, Switch, Dial] button and then select master channel side control.

### ●Slave channel setting

1. Tap the Slave button to call the Function menu and select the slave channel.

2. To link this mixing with other mixing, tap the "Link" button.

\*Each time the button is pressed, it toggles between mixing direction + and - and "OFF" (no link).

### ●Trim mode ON/OFF setting

1. To turn the trim mode ON/OFF, tap the Trim button on the screen.

\*When mixing includes master side trim, set the Trim button to [ON]. When mixing does not include master side trim, set the Trim button to [OFF].

\*Each time this button is pressed, it toggles between [ON] and [OFF].

\*This is effective when the master channel is set by Function.

### ●Mixing curve type selection

1. Tap the curve type selection button of the curve type you want to use to display the selection screen. Then, select the curve you want to use.

\*For a description of the curve setting method, see the description at the back of this manual.

### ●Fine tuning trim setting

1. When using the curve fine tuning function, tap the [--] button of the Fine Tuning item to call the <Switch> screen and then select the lever, VR, etc. you want to use.

\*For a description of the fine tuning trim setting method, see the description at the back of this manual.

### ●Servo speed setting

1. When setting the servo speed, tap the speed button. The Servo speed setup screen is displayed.

\*For a description of the servo speed setting method, see the description at the back of this manual.

\*Offset mixing changes the speed. Use the Speed In and Speed Out buttons to readjust the speed.

The mixing switch can set a delay with a different rate at starting and stopping.

\*This function is inactive when a mixing switch is not set.



## MODEL MENU (Airplane/Glider/Multicopter functions)

The dedicated mixes, etc. usable when airplane or glider model type is selected are displayed in this Model menu functions section. First use the Model type function of the Linkage menu to preset the model type, wing type, and tail type matched to the fuselage used. Other settings reset the data used in mixing function, etc.

These dedicated mixes can be set for each flight condition, as required. When you want to use the system by switching the settings for each

condition by switch or stick position, use the Condition select function to add flight conditions. (Up to 8 conditions can be used)

Note: The FX-36 is designed so that the airplane and glider model types can handle aircraft of the same wing type.

The functions common to airplanes and gliders, except some dedicated functions, are summarized without regard to the model type.

The setting items are different, depending on the number of servos, etc. according to the wing type used. The setup screens in the instruction manual are typical examples.

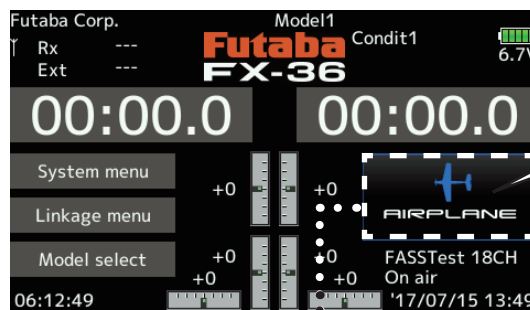

Tap this icon to go to the model menu.

- Select the function name and return to the Home screen.

Model menu	Model1 Condit.1	6.7V	1/2
Servo monitor	Condition select	AFR	
Dual rate	Program. mixes	Aileron differential	
Flap setting	AIL → Camber flap	AIL → Brake flap	
Aileron → Rudder	Elevator → Camber	Camber mixing	
Airbrake → ELE	Camber flap → ELE	Rudder → Aileron	
Rudder → Elevator	Snap roll	Air brake	

(Model menu screen example)

\*The Model menu screen depends on the model type.

### Model menu (Airplane/Glider/Multicopter) functions table

#### Aileron differential

This function adjusts the left and right ailerons. Roll axis correction and fine tuning with a VR are also possible. This is convenient when making settings during flight.

[Airplane/glider, 2 ailerons or more]

#### Flap setting

The flaps can be adjusted independently. For a 4 flaps model, the camber flaps can be mixed with the brake flaps. [Airplane/glider, 2 flaps or more]

#### AIL → Camber flap

This mix operates the camber flaps in the aileron mode. It improves the operation characteristic of the roll axis. [Airplane/glider, 2 ailerons + 2 flaps or more]

#### AIL → Brake flap

This mix operates the brake flaps in the aileron mode. It improves the operation characteristic of the roll axis. [Airplane/glider, 4 flaps or more]

#### Aileron → Rudder

This mix is used when you want to operate the rudder at aileron operation. Banking at a shallow bank angle is possible. [Airplane/glider, general]

#### Elevator → Camber

This mix is used when you want to the mix camber flaps with elevator operation. Lifting force can be increased at elevators up. [Airplane/glider, 2 ailerons or more]



### Camber mixing

This mix adjusts the camber and corrects the elevators. [Airplane/glider, 2 ailerons or more]

### Airbrake→ELE

This mix is used to correct operation of the airbrakes (spoilers) when landing. [Airplane/glider, general]

### Camber flap→ELE

This mix is used to correct for attitude changes when the camber flaps are being used. [Airplane/glider, 2 ailerons + 1 flap or more]

### Rudder→Aileron

This function is used to correct roll knife edge, etc. of stunt planes. [Airplane/glider, general]

### Rudder→Elevator

This function is used to correct roll maneuvers, knife edge, etc. of stunt planes. [Airplane, general]

### Butterfly (Crow)

This function is used when powerful brake operation is necessary. [Glider, 2 ailerons or more]

### Trim mix 1/2

The ailerons, elevators, and flaps trim offset rate can be called by switch or condition selection. [Glider general]

### Snap roll

This function selects the snap roll switch and adjusts the steering angle of each rudder. Servo speed can also be adjusted. [Airplane general]

### Air brake

This function is used when airbrakes are necessary when landing or when diving, etc. during flight. [Airplane, general]

### Gyro

This is a dedicated mix when a GYA Series gyro is used. [Airplane/glider/multicopter, general]

### Ailevator

This function adjusts the elevators and ailerons of models with elevator specifications. [Airplane/glider, elevator specifications]

### Acceleration

Allows a brief "overload" in response to sudden Elevator, Elevator→Camber, and Ail→Rudder. [Glider general]

### Motor

The operation speed when the motor of F5B and other EP gliders is started by switch can be set. [Airplane/glider, general]

### V-Tail

This function adjusts the elevators and rudder of V-tail models. [Airplane/glider, V-tail specifications]

### Winglet

This function adjusts the left and right rudders of winglet models. [Airplane/glider, winglet specifications]

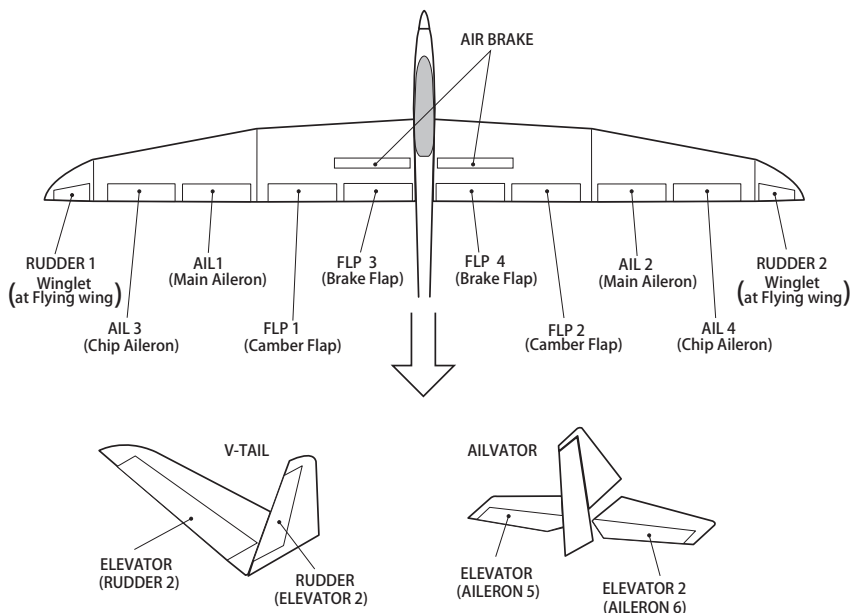



# Aileron differential [Airplane/glider, 2 ailerons or more]

The left and right aileron differential can be adjusted independently. The differential rate can also be adjusted according to the flying state by setting a fine tuning VR.

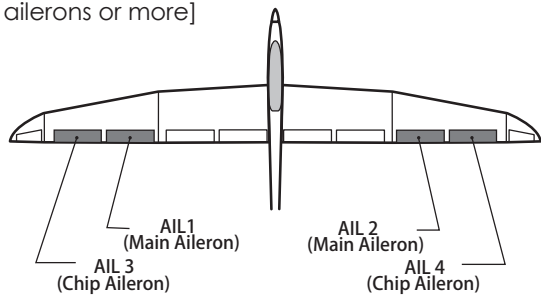

- Select [Aileron differential] at the model menu and call the setup screen shown below.
- Return to Model menu

**Currently selected condition name**

Aileron differential	New Condit.1	6.7V				
	Left	Right	Group	Fine tuning		
Aileron	100	100	Gr.	--		
Aileron2	100	100		Curve		
Aileron3	100	100				
Aileron4	100	100				

**Condition group/single mode selection (Gr./Sngl)**  
(For more information, see the description at the back of this manual.)

**Aileron left/right adjustment**

\*The display screen is an example. The actual screen depends on the Model Type.

**Fine tuning VR setting**  
 \*The graph is operated by setting a VR, etc.

**Aileron differential** New Condit.1 6.7V

+100	Pos.	+0	Rate	+0	
------	------	----	------	----	--

EXP 1	Separ.
Offset	0.0
Rate A	Rate B
+100.0	+100.0
EXP A	EXP B
0.0	0.0

● **Fine tuning VR operation curve setting**  
(For a description of the setting method, see the description at the back of this manual.)

## Setting method

- Tap to the aileron (AIL) 1~4(2) left (or right) setting item.  
Adjust the aileron angles.
- When setting the fine tuning VR, tap the "--" item and tap the screen to call the selection screen, and then select the fine tuning VR.
- The fine tuning rate can be set by curve.

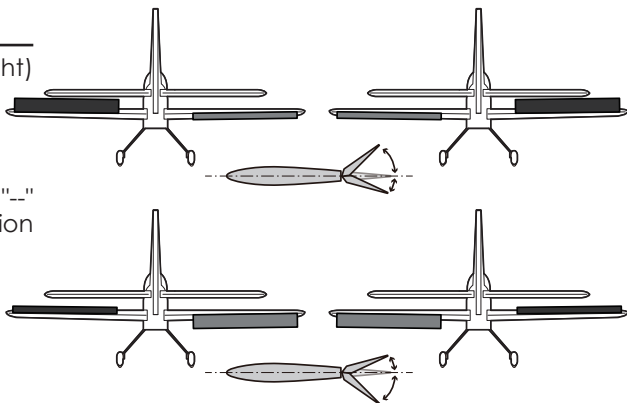



# Flap setting

[Corresponding model type]: Airplane/  
glider, 2 flaps or more]

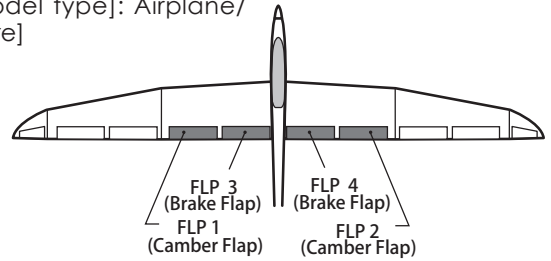

The up/down travel of each flap (camber flaps: FLP1/2, brake flaps: FLP3/4) can be adjusted independently at each servo according to the wing type.

- The operation reference point of each flap can be offset

The camber flaps of a 4-flap model can be mixed with the brake flaps. (Brake FLP to camber FLP)

- An ON/OFF switch can be set.
- Select [Flap setting] at the model menu and call the setup screen shown below.

• Return to Model menu

Flap setting Model1 Condit1 6.7V 1/2

Group	Camber flap		Brake flap	
	Flap	Flap2	Flap3	Flap4
Up	+100	+100	+100	+100
Down	+100	+100	+100	+100
Offset	+0	+0	+0	+0

Camber flap setting      Brake flap setting

Flap setting Model1 Condit1 6.7V 2/2

Group	Brake flap → Camber flap	
	Status	Switch
Up	+100	INH
Down	+100	--
Offset	+0	

Brake flap to Camber flap setting

**Currently selected condition name**

**Condition group/single mode selection (Gr./Sngl)** (For more information, see the description at the back of this manual.)

**Up side/Down side adjustment**

**Operation reference point offset**

**Operation is performed via the volume switches, etc., set for each flap control of the function.**

**The operational volume switch is set up by "Function"**

**Mixing INH ⇄ ON**

**The ON/OFF switch of mixing is chosen.**

\*The display screen is an example. The actual screen depends on the Model Type.

## Setting method

- Tap flap (FLP) 1~4 up or down according to the wing type.  
Adjust the travel independently.
- To offset the operation reference point of each flap, tap the corresponding offset item. Use the "▼▼" "▼" "▲" "▲▲" button to offset the reference point.
- When using brake FLP to camber FLP mixing,

tap the [INH] item and tap the screen. (ON is displayed.)

When setting a switch, tap the [--] item of the switch and tap the screen to call the selection screen. Then, select the switch and set its ON direction. (Always ON at "--" setting) (For a description of the switch selection method, see the description at the back of this manual.)



# AIL → Camber flap [Corresponding model type]: Airplane/glider, 2 ailerons + 2 flaps or more

This mix operates the camber flaps (FLP1/2) in the aileron mode. When the aileron stick is manipulated, the ailerons and camber flaps perform aileron operation simultaneously and the operation characteristic of the roll axis is improved.

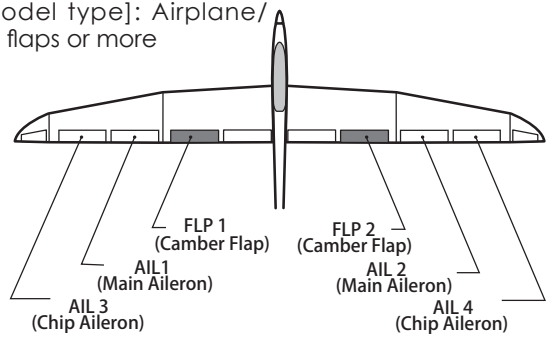

- The aileron left/right mixing rate of each flap servo can be fine-tuned.
- A mixing curve can be set.
- An ON/OFF switch can be set.
- Linking is possible: Link this mix to other mixes.
- Select [AIL→Camber flap] at the model menu and call the setup screen shown below.

• Return to Model menu

● **Mixing curve setting**  
(For a description of the setting method, see the description at the back of this manual.)

Activate the function by tapping the [INH].

Condition group/single mode selection (Gr./Sngl)

The ON/OFF switch of mixing is chosen.

To set linking, tap to the [OFF] item

## Setting method

- Tap [INH].  
(ON is displayed.)
- When setting a switch, tap the [--] item of the switch and tap the screen to call the selection screen, and then select the switch and set its ON direction. (Always ON at "--" setting)  
(For a description of the switch selection method, see the the back of this manual.)
- Tap the left or right item of each flap servo.  
Adjust the mixing rate.

\*When the mixing direction is reversed by the linkage, adjustments can be made by changing the mixing rate polarity (+ or -).

- A mixing curve can be set. (1/2 page)  
(For a description of the mixing curve setting method, see the description at the back of this manual.)
- To set linking, tap the [Link] item.  
Set it to ON and tap the screen.





# AIL → Brake flap

[Corresponding model type]: Airplane/  
glider, 4 flaps or more

This mix operates the brake flaps (FLP3/4) in the aileron mode. When the aileron stick is manipulated, the aileron and brake flaps perform the aileron operation simultaneously and the operation characteristic of the roll axis is improved.

- The aileron left and right mixing rates can be adjusted for each flap servo.
- A mixing curve can be set.
- Mixing during flight can be turned ON/OFF by setting a switch. (Always ON at [-] setting)
- Linking can be set: Link this mix to other mixes.
- Select [AIL→ Brake flap] at the model menu and call the setup screen shown below.

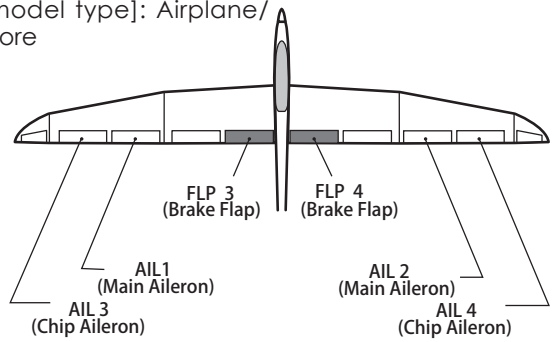

- Return to Model menu

● **Mixing curve setting**  
(For a description of the setting method, see the description at the back of this manual.)

Currently selected condition name

AIL → Brake flap New Condit.1 6.7V 1/2

Pos.	+0	Rate	+0
------	----	------	----

Graph showing a linear mixing curve from -150 to +150.

EXP 1	Separ.
Offset	0.0
Rate A	Rate B
+100.0	+100.0
EXP A	EXP B
0.0	0.0

Left/right overall adjustment at Rate A and Rate B

Activate the function by tapping the [INH].

Condition group/single mode selection (Gr./Sngl)

The ON/OFF switch of mixing is chosen.

To set linking, tap to the [OFF] item

AIL → Brake flap New Condit.1 6.7V 2/2

Status: INH

Group: Gr.

Switch: --

Link: OFF

Travel	Left	Right
Flap3	+0	+0
Flap4	+0	+0

Adjustment of each flap servo

## ● Setting method

- Tap the INH item.  
(ON is displayed.)
- When setting a switch, tap to the [--] item of the switch and tap the screen to call the selection screen, and then select the switch and set its ON direction. (Always ON at "--" setting)  
(For a description of the switch selection method, see the at the back of this manual.)
- Tap the left or right button of each flap servo. Adjust the mixing rate.

\*When the mixing direction is reversed by the linkage, adjustments can be made by reversing the mixing rate polarity (+ or -).

- A mixing curve can be set.  
(For a description of the curve setting method, see the description at the back of this manual.)
- To set linking, tap the Link item.  
Set it to ON and tap the screen.





# Aileron → Rudder

[Corresponding model type]:  
Airplane/glider, general

Use this mix when you want to mix the rudders with aileron operation.

- A mixing curve can be set.
- Mixing during flight can be turned ON/OFF by setting a switch. (Always ON at [--] setting)
- The mixing rate can be fine-tuned by setting a VR.

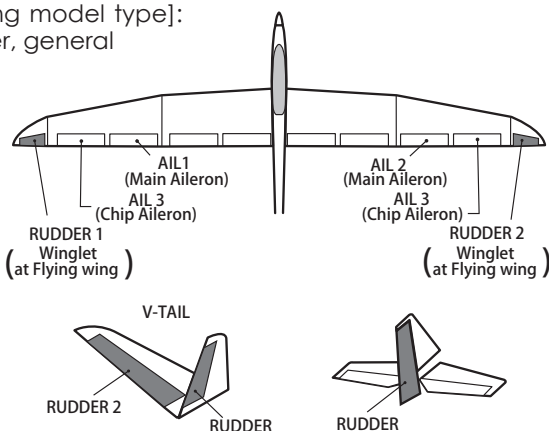
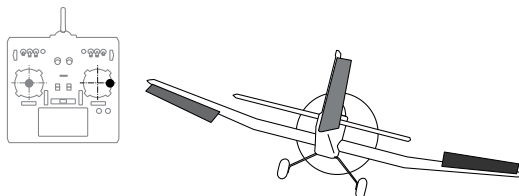

- Select [Aileron→ Rudder] at the model menu and call the setup screen shown below.

- Return to Model menu

● **Mixing curve setting**  
(For a description of the setting method, see the description at the back of this manual.)

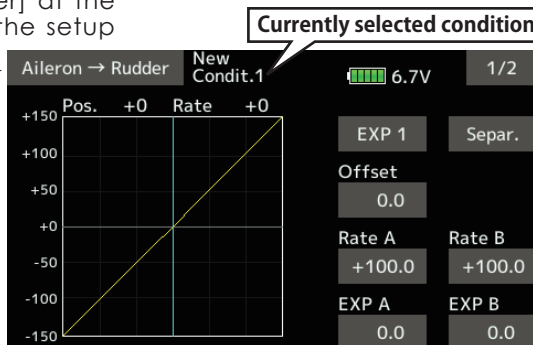

Left/right overall adjustment at Rate A and Rate B

Activate the function by tapping the [INH].

Condition group/single mode selection (Gr./Sngl)

The ON/OFF switch of mixing is chosen.

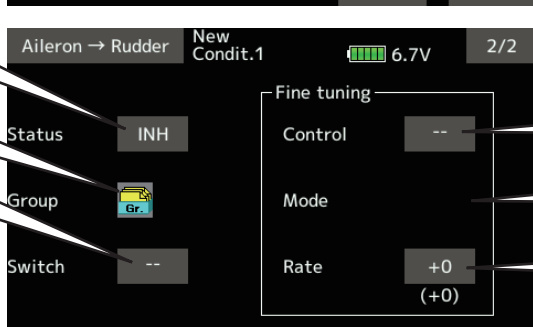

Fine tuning VR setting

Operation mode

Adjustment rate

## Setting method

- Tap [INH].  
(ON is displayed.)
- When setting a switch, tap to the [--] item of the switch and tap the screen to call the selection screen, and then select the switch and set its ON direction. (Always ON at "--" setting)  
(For a description of the switch selection method, see the back of this manual.)
- When setting a VR, tap to the Fine Tuning "--" item and tap the screen to call the selection screen, and then select the VR. The adjustment rate can be set. The VR operation mode can also be selected.
- A mixing curve can be set.  
(For a description of the curve setting

method, see the description at the back of this manual.)

[Fine tuning VR operation mode]

[LIN.] Mixing rate 0% at center of VR. When the VR is turned clockwise and counterclockwise, the mixing rate increases and decreases, respectively.

[ATL+] Mixing rate 0% at left end of VR. When the VR is turned, the mixing rate increases.

[ATL-] Mixing rate 0% at right end of VR. When the VR is turned, the mixing rate increases.

[SYM.] When the VR is turned to the left or right of the neutral position, the mixing rate increases.



# Elevator → Camber [Corresponding model type]: Airplane/glider, 2 ailerons or more

This function is used when you want to mix the camber flaps with elevator operation. When used, the flaps are lowered by up elevator, and lift can be increased.



**Note: Tailless wing elevator can be operated when this mix is activated.**

- A mixing curve can be set.
- Mixing during flight can be turned ON/OFF by setting a switch. (Always ON at [--] setting)
- The mixing rate can be fine-tuned by setting a VR.

- Select [Elevator→Camber] at the model menu and call the setup screen shown below.

- Return to Model menu

● **Mixing curve setting**  
(For a description of the setting method, see the description at the back of this manual.)

Currently selected condition name

Overall adjustment by Rate A and Rate B.

Ailerons and flaps rate adjustment

The value inside the parentheses shows the current rudder position.

Activate the function by tapping the [INH].

Condition group/single mode selection (Gr./Sngl)

The ON/OFF switch of mixing is chosen.

Fine tuning VR setting

Operation mode

Adjustment rate

## Setting method

- Tap [INH].  
(ON is displayed.)
- When setting a switch, tap the [--] item of the switch and tap the screen to call the selection screen, and then select the switch and set its ON direction. (Always ON at "--" setting)

(For a description of the switch selection method, see the description at the back of this manual.)

- When setting a VR, tap the Fine tuning "--" item and tap the screen to call the selection screen, and then select the VR. The adjustment rate can be set.

The VR operation mode can also be selected.

- A mixing curve can also be set.  
(For a description of the curve setting method, see the description at the back of this manual.)



# Camber mixing

[Corresponding model type]: Airplane/glider, 2 ailerons or more

This function adjusts the rate of camber operation which operates the wing camber (ailerons, camber flaps, brake flaps) in the negative and positive directions. The aileron, flap, and elevator rates can also be adjusted independently by curve, and attitude changes caused by camber operation can be corrected.

- The up/down side rates of the aileron, flap, and elevator servos can be adjusted by curve. When the mixing direction is reversed by the linkage, adjustments can be made by changing the mixing rate polarity (+ or -).
- Mixing during flight can be turned ON/OFF by setting a switch. (Always ON at [-] setting)
- A delay can be set for each condition. A cut switch which can turn OFF the delay function can be set.
- The speed of the aileron, flap, and elevator servos can be set. (In side/Out side)

- Select [Camber mixing] at the model menu and call the setup screen shown below.

**Activate the function by tapping the [INH].**

**Condition group/single mode selection (Gr./Sngl)**

**The ON/OFF switch of mixing is chosen.**

**Condition delay cut switch**

**Condition delay setting**

**Currently selected condition name**

**Servo speed setting (For a description of the setting method, see the description at the back of this manual.)**

• Return to Model menu

**Ailerons, flaps and elevators rate adjustment**

	AIL3	AIL	AIL2	AIL4	ELE
Rate 1	+0	+0	+0	+0	+0
Rate 2	+0	+0	+0	+0	+0
	FLP3	FLAP	FLP2	FLP4	ELE2
Rate 1	+0	+0	+0	+0	+0
Rate 2	+0	+0	+0	+0	+0

**Mixing curve setting (For a description of the setting method, see the description at the back of this manual.)**

**Overall adjustment by Rate A and Rate B.**



## Setting method

- Tap [INH].  
(ON is displayed.)
- When setting a switch, tap to the [--] item of the switch and tap the screen to call the selection screen, and then select the switch and set its ON direction. (Always ON at "--" setting)

(For a description of the switch selection method, see the description at the back of this manual.)

- When setting a condition delay, tap to the [Condition delay] item.

Set the delay.

When setting a cut switch, tap [Cut-switch] and tap the screen to call the selection screen, and then select the switch and set its ON direction. (Always ON at [--] setting)

(For a description of the condition delay function, see the description at the back of this manual.)

(Curve/rate setup screen)

- The curve and rate are adjusted by calling the aileron, flap, and elevator curve/rate screens.

The rate and curve of each servo can be set by calling each screen. (For a description of the curve setting method, see the description at the back of this manual.)

The servo speed can also be adjusted.

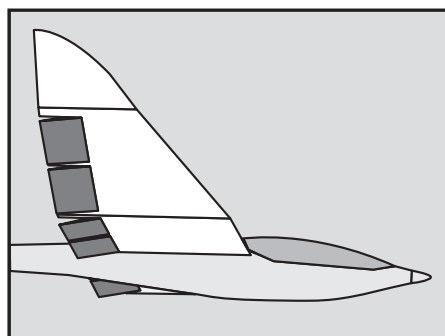
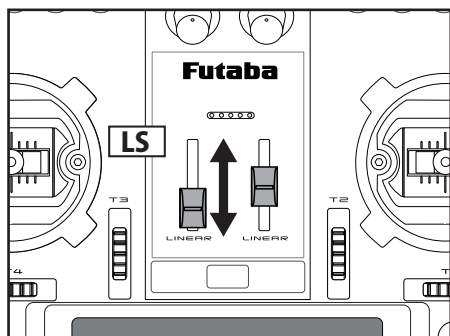
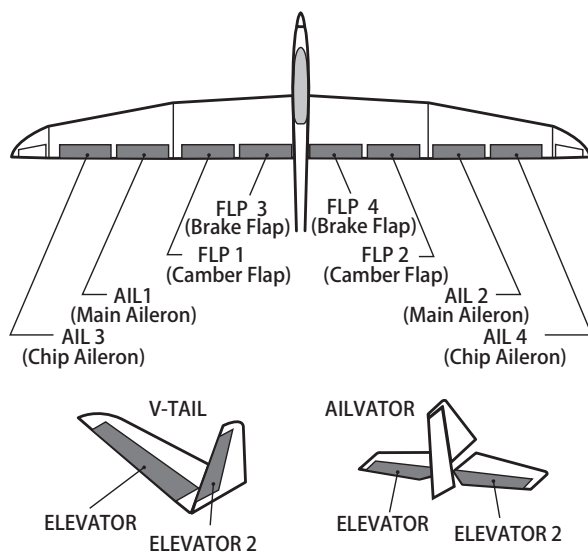



# Airbrake → ELE

[Corresponding model type]:  
Airplane/glider, general

This mix is used when you want to mix the elevators with airbrake (spoiler) operation. It raises the elevators to correct for dropping of the nose during airbrake operation.

\*This function does not operate when airbrake is not assigned at the Function menu in the Linkage menu.

- The Rate 1 side/Rate 2 side mixing rate with the elevator servos can be adjusted.
- A mixing curve can be set.
- Mixing during flight can be turned ON/OFF by setting a switch. (Always ON at [-] setting)
- The mixing rate can be fine-tuned by setting a VR.

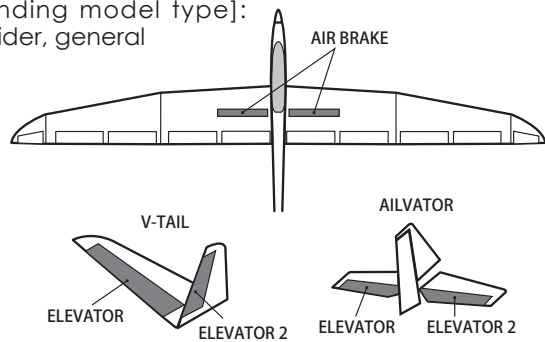

\*The display screen is an example. The actual screen depends on the model type.

- Select [Airbrake→ ELE] at the model menu and call the setup screen shown below.

- Return to Model menu

● **Mixing curve setting**  
(For a description of the setting method, see the description at the back of this manual.)



Up/Down overall adjustment at Rate A and Rate B

Activate the function by tapping the [INH].

Condition group/single mode selection (Gr./Sngl)

The ON/OFF switch of mixing is chosen.

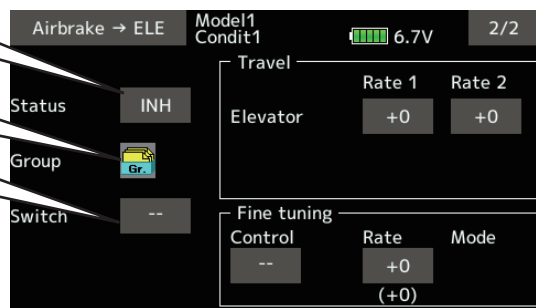

Adjustment of elevator servo

Fine tuning setting

## Setting method

- Tap [INH].  
(ON is displayed.)
- When setting a switch, tap the [--] item of the switch and tap the screen to call the selection screen, and then select the switch and set its ON direction. (Always ON at "--" setting)  
(For a description of the switch selection method, see the description at the back of this manual.)
- When setting a VR, tap the Fine tuning

"--" item and tap the screen to call the selection screen, and then select the VR. The adjustment rate can be set. The VR operation mode can also be set.

(For a description of the fine tuning VR setting method, see the description at the back of this manual.)

- A mixing curve can be set.  
(For a description of the curve setting method, see the description at the back of this manual.)



## Camber flap → ELE

[Corresponding model type]: Airplane/  
glider, 2 ailerons + 1 flap or more

This mixing is used to correct changes (elevator direction) generated when the camber flaps (speed flaps) are used.

- The elevator servos up side/down side rate can be adjusted. When the mixing direction is reversed by the linkage, adjustments can be made by changing the mixing rate polarity (+ or -).
- A mixing curve can be set.
- Mixing during flight can be turned ON/OFF by setting a switch. (Always ON at [--] setting)
- The mixing rate can be fine-tuned by setting a VR.

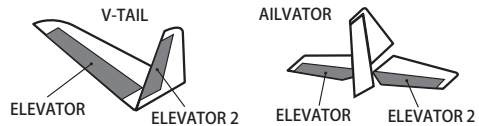
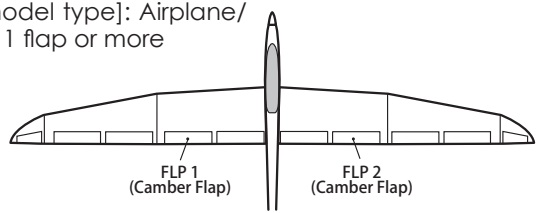

- Select [Camber flap→ELE] at the model menu and call the setup screen shown below.

- Return to Model menu

● **Mixing curve setting**  
(For a description of the setting method, see the description at the back of this manual.)

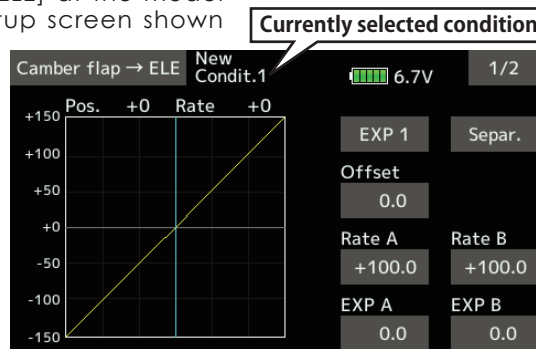

Currently selected condition name

Up/Down overall adjustment at Rate A and Rate B

Activate the function by tapping the [INH].

Condition group/single mode selection (Gr./Sngl)

The ON/OFF switch of mixing is chosen.

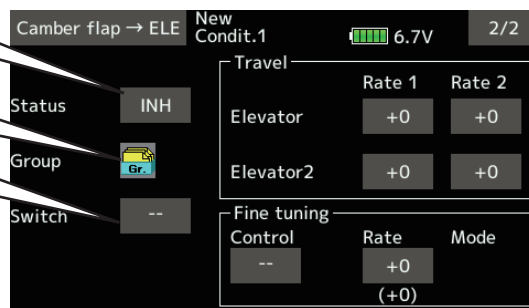

Adjustment of elevator servo

Fine tuning setting

### Setting method

- Tap [INH].  
(ON is displayed.)
- When setting a switch, tap to the [--] item of the switch and tap the screen to call the selection screen. Then, select the switch and set its ON direction. (Always ON at [--] setting)  
(For a description of the switch selection method, see the description at the back of this manual.)
- Tap elevator servos. Adjust the mixing rate.

\*When the mixing direction is reversed by the linkage, adjustments can be made by changing the mixing rate polarity (+ or -).

- When setting a VR, tap the Fine tuning "--" item and tap the screen to call the selection screen, and then select the VR. The VR operation mode can be selected.
- A mixing curve can be set.  
(For a description of the curve setting method, see the description at the back of this manual.)



# Rudder → Aileron

[Corresponding model type]:  
Airplane/glider, general

This function is used when you want to mix the ailerons with rudder operation. It is used when rudder is applied during roll maneuvers, knife edge, etc. of stunt planes. It can be used to bank scale models, large models, etc. like a full size plane.

- A mixing curve can be set.
- Mixing during flight can be turned ON/OFF by setting a switch. (Always ON at [--] setting)
- Linking can be set: Link this mix to other mixes.
- The mixing rate can be fine-tuned by setting a VR.

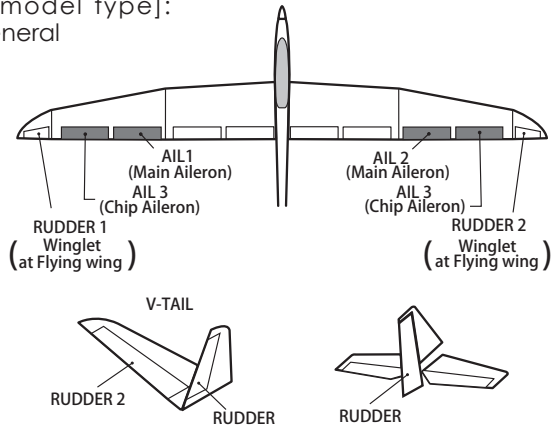

- Select [Rudder→Aileron] at the model menu and call the setup screen shown below.

- Return to Model menu

● **Mixing curve setting**  
(For a description of the setting method, see the description at the back of this manual.)

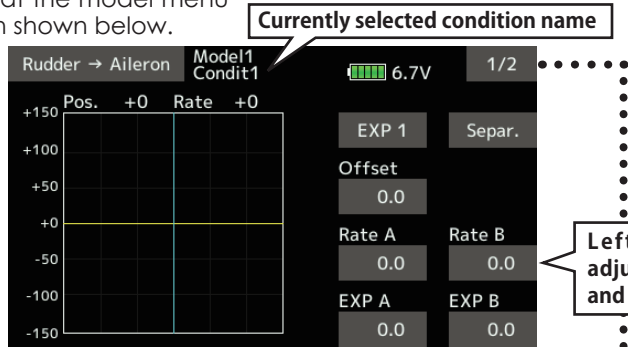

Activate the function by tapping the [INH].

Condition group/single mode selection (Gr./Sngl)

The ON/OFF switch of mixing is chosen.

To set linking, tap to the [OFF] item

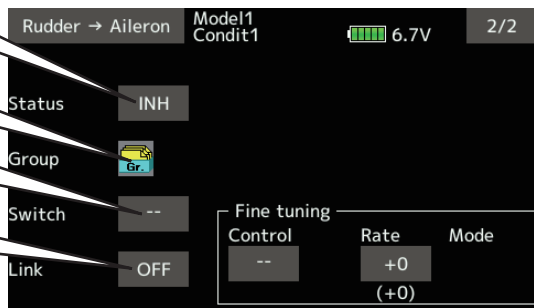

Fine tuning setting

## Setting method

- Tap [INH].  
(ON is displayed.)
- When setting a switch, tap to the [--] item of the switch and tap the screen to call the selection screen. Then, select the switch and set its ON direction. (Always ON at "--" setting) (For a description of the switch selection method, see back of this manual.)
- When setting a VR, tap to the Fine tuning "--" item and tap the screen to call the selection screen and then select the VR. The adjustment rate can be set.

The VR operation mode can also be set.  
(For a description of the fine tuning VR setting method, see the description at the back of this manual.)

- A mixing curve can be set.  
(For a description of the curve setting method, see the back of this manual.)
- When linking: tap the [Link] item. (ON is displayed.)





# Rudder → Elevator

[Corresponding model type]: Airplane, general

This function is used when you want to mix elevator operation with rudder operation. It is used to correct undesirable tendencies when rudder is applied in roll maneuvers, knife edge, etc. of acrobatic planes.

- A mixing curve can be set.
- Mixing during flight can be turned ON/OFF by setting a switch. (Always ON at [-] setting)
- Select [Rudder→Elevator] at the model menu and call the setup screen shown below.

- Link can be set: Links this mixing to other mixings.
- The mixing rate can be fine-tuned by setting a VR. (Fine tuning)

- Return to Model menu

● **Mixing curve setting**  
(For a description of the setting method, see the description at the back of this manual.)

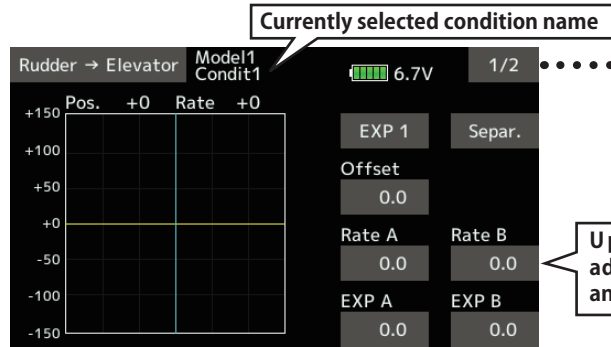

Activate the function by tapping the [INH].

Condition group/single mode selection (Gr./Sngl)

The ON/OFF switch of mixing is chosen.

To set linking, tap to the [OFF] item

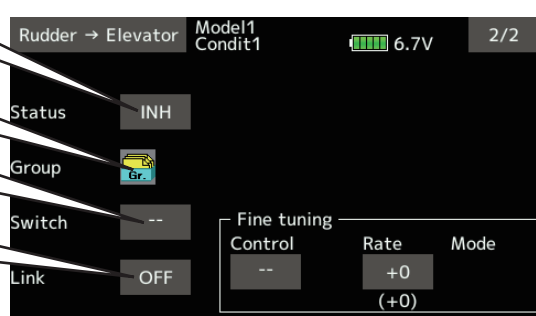

Fine tuning setting

## Setting method

- Tap [INH]. (ON is displayed.)
- When setting a switch, tap to the [--] item of the switch and tap the screen to call the selection screen. Then, select the switch and set its ON direction. (Always ON at "--" setting) (For a description of the switch selection method, see the description at the back of this manual.)
- When setting a VR, tap the Fine tuning "--" item and tap the screen to call the selection screen and then select the VR. The

adjustment rate can be set.

The VR operation mode can also be set.

(For a description of the fine tuning VR setting method, see the description at the back of this manual.)

- A mixing curve can be set. (For a description of the curve setting method, see the description at the back of this manual.)
- When linking: tap the [Link] item. (ON is displayed.)





# Butterfly

[Corresponding model type]: Glider, 2 ailerons or more

This function allows powerful brake operation by simultaneously raising the left and right ailerons and lowering the flaps (camber flap, brake flap).

This setting will allow the ailerons to be raised while the flaps are simultaneously lowered. Butterfly (crow) produces an extremely efficient landing configuration by accomplishing the following:

1. Slow the aircraft's velocity.
2. Provide washout at the wing tips to reduce the tendency to tip stall.
3. Create more lift toward the center of the wing allowing it to fly at a slower speed.

- Mixing during flight can be turned ON/OFF by setting a switch. (Always ON at [-] setting)
- The butterfly operation reference point can be offset. When the screen is tapped with the offset item selected, when operated to the position to be changed, the reference point is offset. If the reference point is offset too much, unexpected operation may be performed.
- The ailerons and flaps operation speed can be adjusted. (In side/Out side)
- A delay can be set for each condition. A cut switch which can turn OFF the delay function can also be set.
- The differential rate can be adjusted.

\*When servo binding occurs when setting the ailerons and flaps in butterfly mixing, use the AFR function to adjust the rate.

\*The display screen is an example. The actual screen depends on the model type.

**When using this function, Tap [INH]. (ON is displayed.)**

**Condition group/single mode selection (Gr. / Sngl)**

**The ON/OFF switch of mixing is chosen.**

**Condition delay setting**

- Select [Butterfly] at the model menu and call the setup screen shown below.

**Condition delay cut switch**

**The differential rate can be adjusted.**

**To next page**

\*When differential rate is "+", Up rate is decrease and DOWN rate is increase.

\*When differential rate is "-", the calculation method of UP/DOWN and a direction become reverse.

**When offsetting the butterfly operation reference point, operate to the throttle stick point you want to change and then touch the Offset button. The reference point displays 0%. When [Yes] is touched, the reference point is changed. Then, "Initialize elevator curve?" appears, allowing you to confirm your setting.**

\*The display screen is an example. The actual screen depends on the Model Type.



●Return to Model menu

Butterfly NEW Condit.1 6.8V 2/2

Mixing rate

AIL3	AIL	AIL2	AIL4		
+0	+0	+0	+0		
FLP3	FLAP	FLP2	FLP4	ABK	Mode
+0	+0	+0	+0	+0	A

Elevator setting

Curve	Rate 1	ELE	ELE2	Fine tuning
	+0	+0	+0	Control RD
	Rate 2	+0	+0	Rate (+0) Mode
				+20 LIN.

Select the Mixing Rate AIL and FLP box. Adjust the mixing rates.

Elevator rate adjustment

Fine tuning setting

\*In case of tailless wing not display.

(To elevator curve setup screen)

(Elevator correction rate setup screen)

The offset position is indicated by a red dotted line by an elevator curve.

Butterfly Model1 Condit.1 6.7V

Pos. -84 Rate +0

Point	Separ.
Offset	0.0 Add
Position	0.0 Rate
	+34.5

Overall adjustment by Rate A and Rate B

Mixing curve setting  
\*For a description of the curve setting method, see the description at the back of this manual.

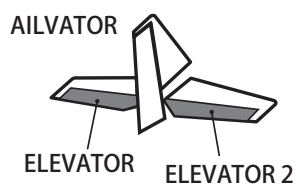
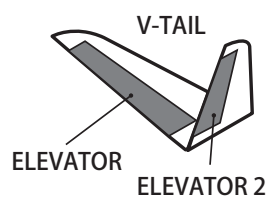
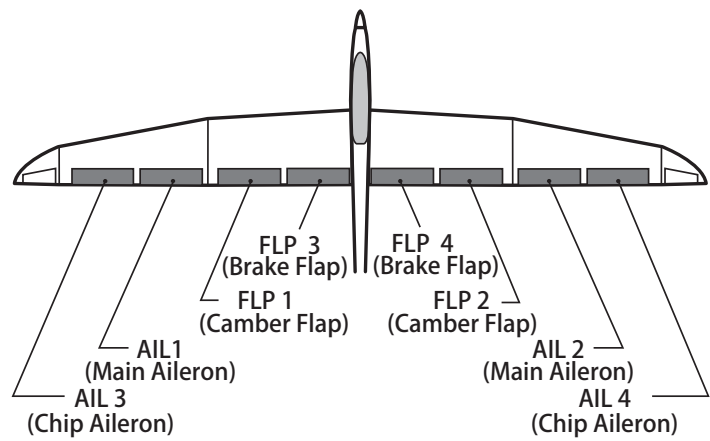
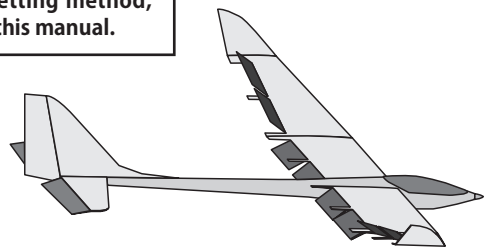



Butterfly NEW Condit.1 6.8V 2/2

Mixing rate

AIL3	AIL	AIL2	AIL4	
+0	+0	+0	+0	
FLP3	FLAP	FLP2	FLP4	ABK
+0	+0	+0	+0	+0

Elevator setting

Curve	Rate 1	ELE	ELE2	Fine tuning
		+0	+0	Control RD
	Rate 2	+0	+0	Rate (+0) Mode
				+20 LIN.

Mode A



**Throttle stick full stroke MODE**

- **Mode A**  
(Normal)
- The butterfly operation direction is reversed at the neutral position (50) of the throttle stick.
- **Mode B**  
(Throttle stick full stroke MODE)
- It does not reverse at the neutral position, so you can set the butterfly operation start point with the full stroke of the throttle stick.

**At offset 20**

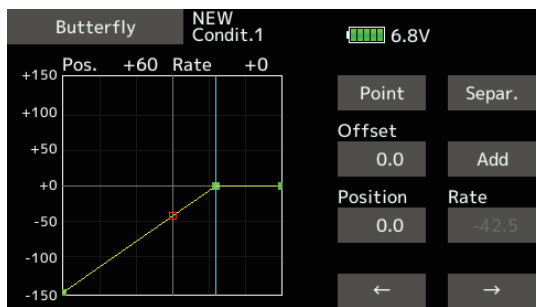

**At offset 20**

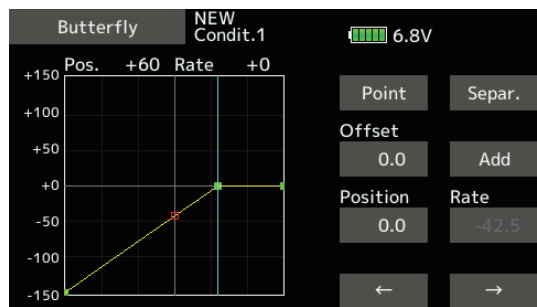

**At offset 70**

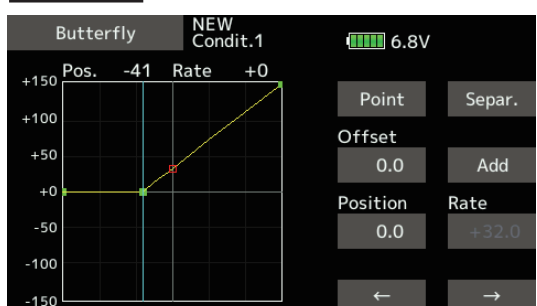

**At offset 70**



The direction of butterfly motion is reversed.

The direction of butterfly motion is not reversed.



# Trim mix 1/2

[Corresponding model type]: Glider, general

These functions call the ailerons, elevators, and flaps (camber flaps, brake flaps) trim offset rates preset according to the flight state.

The amount of ailerons, elevator, and flaps (camber flap, brake flap) trim offset can be set to a switch.

As an example **Trim mix 1** can be set up for launching, with speed flaps and ailerons dropped, and a slight amount of up elevator. **Trim mix 2** can be used for high speed flying, with both ailerons and speed flaps reflexed slightly, and a bit of down elevator.

The trim functions can be activated during flight by setting a switch. To prevent sudden trim changes when switching flight conditions, a delay can be set to provide a smooth transition between the two. Trim mix 2 will have priority over Trim mix 1.

**Example**

- Move to the [INH] item. Set the trim mix function to [ON].  
\*When separating the settings for each condition, move to the [Group] item and set it to [Single].
- Select the ON/OFF switch.
- Select the [Manual] or [Auto] mode.  
In the [Auto] mode, also select an auto SW. This switch can be linked to a stick, etc.

<Speed>  
In: The operation speed at switch ON can be set.  
Out: The return speed at switch OFF can be set.

<Fine Tuning>  
The offset rate can be varied in the Fine Tuning numeric range set at screen by VR, etc. selection.

<Condition Delay>  
When flight conditions are set, the operation speed can be set for each condition. Condition delay operation can be interrupted and each rudder quickly returned to its original position by selecting a cut switch.

\*The display screen is an example. The actual screen depends on the Model type.

When using this function, Tap [INH]. (ON is displayed.)

The ON/OFF switch of mixing is chosen.

Manual/Auto mode selection  
Manual: Switches the function ON/OFF by switch  
Auto: Trim mix function call can be linked to a stick, etc. A stick switch, etc. separate from the function ON/OFF switch is set.

Condition delay setting

- Select [Trim mix1 or 2] at the model menu and call the setup screen shown below.

To next page

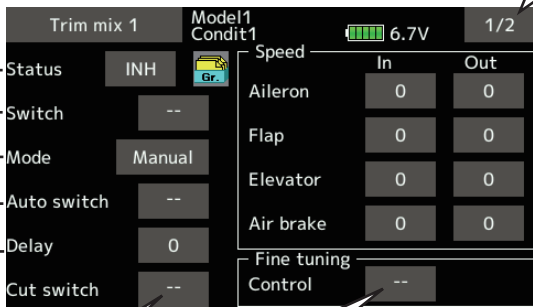

Condition delay cut switch

When a fine tuning VR is set, the trim rates of ailerons, flaps and elevators can be adjusted.

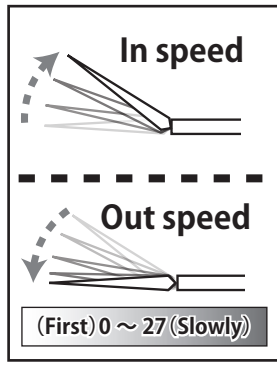

- Return to Model menu

Trim mix 1	Model1 Condit1				
	AIL3	AIL	AIL2	AIL4	ABK
Offset	+0	+0	+0	+0	+0
Fine tuning	+0 (+0)	+0 (+0)	+0 (+0)	+0 (+0)	+0 (+0)
FLP3	+0	FLAP	FLP2	FLP4	ELE
	+0		+0	+0	+0
	+0	+0	+0	+0	+0
	(+0)	(+0)	(+0)	(+0)	(+0)

The value inside the parentheses shows the current rudder position.

The offset rate of ailerons, flaps and elevators can be adjusted. Tap to the corresponding setting item. Adjust the rate.



# Snap roll

[Corresponding model type]: Airplane, general

This function selects the switch and rate adjustment of each rudder, (ailerons, elevators, or flaps) when a snap roll is performed.

- Four snap roll directions can be set. (Right/up, right/down, left/up, left/down)
  - Operation mode: When [Master] mode is selected, the Snap Roll function is turned ON/OFF by master switch in the state in which the direction switch was switched to the direction in which you want to snap roll. When [Single] mode is selected, snap roll in each direction can be executed by means of independent switches.
  - A safety switch can be set. As a safety measure, the switch can be set so that snap roll is not executed when, for instance, the landing gear is lowered, even if the switch is turned on accidentally. The snap roll switch is activated only when the safety switch is ON.
  - The operation speed of the aileron, elevator, and flap servos can be adjusted for each snap roll direction. (In side/out side)
- Select [Snap roll] at the model menu and call the setup screen shown below.

**(Example) Setting example for F3A**

- Mode: [Master]
- Safety SW: [SW-G] (Safety measure)
- Master SW: [SW-H] (Main switch for executing snap roll)
- Direction switches:  
 \*The snap roll up side left and right and down side left and right direction switches are selected here.  
 Right/Up: [SW-D] OFF-OFF-ON  
 Right/Down: [SW-D] ON-OFF-OFF  
 Left/Up: [SW-A] OFF-OFF-ON  
 Left/Down: [SW-A] ON-OFF-OFF
- Speed adjustment  
 The operation speed of each control surface when the snap switch is ON can be changed and snap roll executed by stick while there is switch operation can be performed.

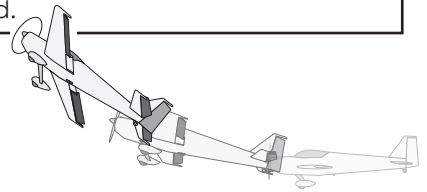

•Return to Model menu

Master or Single is chosen

Snap roll directions

The ON/OFF switch of snap roll is chosen.

The safety switch is chosen.

Snap roll		Model1 Condit1	6.7V	1/2
Mode	Master	Master-SW	Safety-SW	Gr
ACT/INH	OFF	Switch	Aileron	Elevator
Right/Up	OFF	--	+100	+100
Right/Down	OFF	--	+100	-100
Left/Up	OFF	--	-100	+100
Left/Down	OFF	--	-100	-100
			Rudder	+100

Master mode : Direction switches  
 Single mode : Snap roll switches

Aileron, elevator and Rudder rate adjustment

To next page

Condition group/ single mode selection (Gr./Sngl)

Snap roll		Model1 Condit1	6.7V	2/2
Speed		Aileron	Elevator	Rudder
		In	Out	In
		Out	In	Out
Right/Up		0	0	0
Right/Down		0	0	0
Left/Up		0	0	0
Left/Down		0	0	0

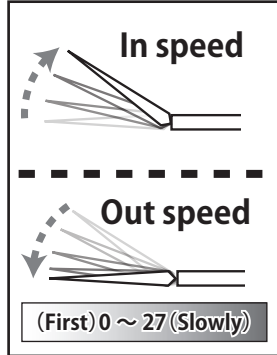



# Air brake

This function is used when an air brake is necessary when landing or diving, etc.

The preset elevators and flaps (camber flap, brake flap) offset amount can be activated by a switch.

The offset amount of the aileron, elevator, and flap servos can be adjusted as needed. Also the speed of the aileron, elevator, and flap servos can be adjusted. (In side/Out side) A delay can be set for each condition, and a Cut switch which will turn OFF the delay can be chosen. Trim amounts can be fine-tuned by setting a VR. You can also set the Auto Mode, which will link Airbrake to a stick, switch, or dial. A separate stick switch or dial can also be set as the ON/OFF switch.

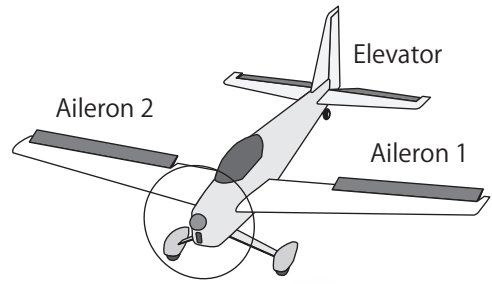

- Select [Air brake] at the model menu and call the setup screen shown below.

\*The display screen is an example. The actual screen depends on the Model Type.

When using this function, Tap [INH]. (ON is displayed.)

The ON/OFF switch of air brake is chosen.

Manual/Auto mode selection  
**Manual:** Switches the function ON/OFF by switch  
**Auto:** Air brake function call can be linked to a stick, etc. A stick switch, etc. separate from the function ON/OFF switch is set.

Air brake		Model1	6.7V		1/2
Condit1					
Status	INH	Speed	In	Out	
Switch	--	Aileron	0	0	
Mode	Manual	Flap	0	0	
Auto switch	--	Elevator	0	0	
Delay	0	Air brake	0	0	
Cut switch	--	Fine tuning	Control		
			--		

Condition delay setting and cut switch setting.

Fine tuning setting

To next page

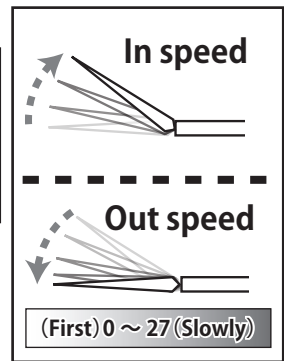

**Offset :** The offset rate of ailerons, flaps, and elevators can be adjusted. Tap to the corresponding setting item. Adjust the rate.

**Fine tuning :** When a fine tuning VR is set on the next page, the ailerons', flaps', and elevators' trim rates can be adjusted. Tap to the corresponding setting item. Adjust the rate.

- Return to Model menu

Air brake		Model1	6.7V		2/2
Condit1					
Offset	AIL3	AIL	AIL2	AIL4	ABK
	+0	+0	+0	+0	+0
Fine tuning	+0	+0	+0	+0	+0
	(+0)	(+0)	(+0)	(+0)	(+0)
	FLP3	FLAP	FLP2	FLP4	ELE
	+0	+0	+0	+0	+0
	(+0)	(+0)	(+0)	(+0)	(+0)

The value inside the parentheses shows the current rudder position.



# Gyro

[Corresponding model type]: Airplane/glider/multicopter, general

This function is used when a GYA Series gyro is used to stabilize the aircraft's attitude. The sensitivity and operation mode (Normal mode/GY mode) can be switched with a switch.

- Three rates (Rate1/Rate2/Rate3) can be switched.
- Up to 3 axes (Gyro/Gyro2/Gyro3) can be simultaneously controlled.

\*Initial setting does not assign a sensitivity channel. Use the

Function menu of the Linkage menu to assign the sensitivity channel (Gyro/Gyro2/Gyro3) used to a vacant channel beforehand.

Set [Control] and [Trim] other than Function to [--].

- Select [Gyro] at the model menu and call the setup screen shown below.

•Return to Model menu →

**Tapping this will change INH to either ON or OFF and enable operation. Adjustment of the three rates (sensitivity) and switching between Normal and AVCS is possible.**

Gyro		Model1 Condit1		6.7V	
Rate	INH	Rate 1	Rate 2	Rate 3	Rate 3
Gr.	Gr.	Gr.	Gr.	Gr.	Gr.
Type	Switch	Type	Switch	Type	Switch
GY	--	GY	--	GY	--
Mode	Rate	Mode	Rate	Mode	Rate
GYRO	Normal 0	Normal 0	Normal 0	Normal 0	Normal 0
GYR2	Normal 0	Normal 0	Normal 0	Normal 0	Normal 0
GYR3	Normal 0	Normal 0	Normal 0	Normal 0	Normal 0

**Condition group/ single mode selection (Gr./Sngl)**

**The ON/OFF switch of gyro is chosen.**

**3 rate (gyro gain) adjustment**

**The operation mode (AVCS/NOR) and sensitivity of the 3 axes Gyro/Gyro2/Gyro3 can be set.**

- Three rates (Rate1/Rate2/Rate3) can be used.  
Tap to the [Rate] item. Adjust the rate.
- When using this function, Tap [INH].
- When a Futaba GYA gyro is used, when [GY] type is selected, the sensitivity set value is directly read in both the AVCS and Normal modes.
- When setting a switch, tap the Switch item and tap the "--" button to call the selection screen, and then select the switch and set its ON direction.  
(For a description of the switch selection method, see the description at the end of this manual.)



(Example) Setting three axis using a GYA440 and GYA441 (2)

- Wing type: Aileron 2 servos mounted fuselage selected
- Set **5CH → Gyro** (GYA441AIL), **7CH → Gyro2** (GYA441ELE), **8CH → Gyro3** (GYA440RUD), **Control and Trim → "-"** : of the Function menu of the Linkage menu.
- Gyro setting of the Model menu.

Rate	ACT	Type	Switch	Gyro	Gyro 2	Gyro 3
1	OFF/ON	GY	SE	AVCS : 60%	AVCS : 60%	AVCS : 60%
2	INH					
3	ON/OFF	GY	SE	Normal : 60%	Normal : 60%	Normal : 60%

\*Set so that Rate 1 is turned on at the back position of switch E and Rate 3 is turned ON at the front position. Since switch E is turned OFF at the center, Rate 2 remains [INH].

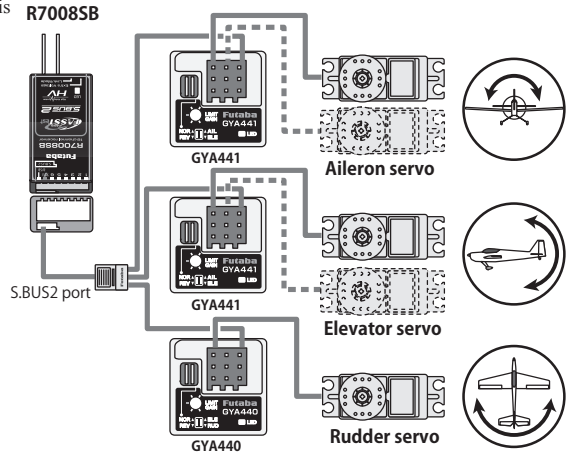
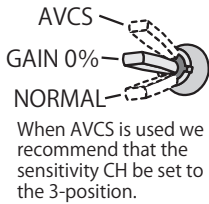





# Ailevator

[Corresponding model type]: Airplane/glider, Tail type  
 Ailevator (Effective only when 2 servos used at the elevators)

This function improves the operating performance of the roll axis by operating the elevators as ailerons.

Ailevator is where each elevator in a standard (conventional) or v-tail moves independently, like ailerons on a wing. In addition to each elevator side moving up and down together, each side moves in opposite directions when moving as an ailevator. On a V-tail, this is also known as a ruddervator, as they can serve the same purpose. Typically, both ailevator and ailerons are coupled together to maximize roll performance, especially on larger wingspan planes.

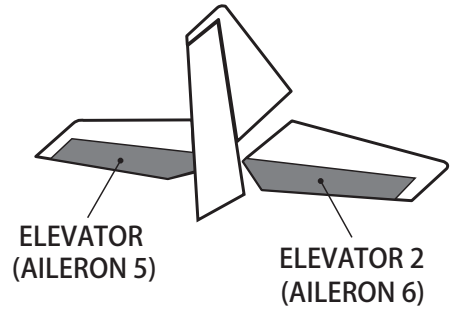

Note: Select ailevator as the Model type at the Model type screen. This changes the output channel. Check the Function menu.

- Select [Ailevator] at the model menu and call the setup screen shown below.

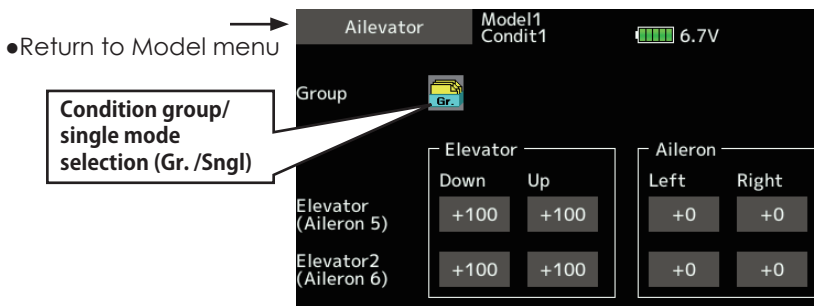

**(Elevator function)**  
 The up and down rates of the left and right elevators when the elevator stick is manipulated can be individually adjusted.

**(Aileron function)**  
 When the elevators are used as ailerons, aileron travel of the left and right elevators can be adjusted.

- Travel adjustment  
 Tap to the item you want to adjust.  
 Adjust the rate using the "▼▼▼" "▲▲▲" buttons.
- \*If the mixing direction is reversed by the linkage, adjustments can be made by changing the mixing rate polarity (+ or -).
- \*If a large value of travel is specified, when the sticks are moved at the same time, the controls may bind or run out of travel. Decrease the travel until no binding occurs.

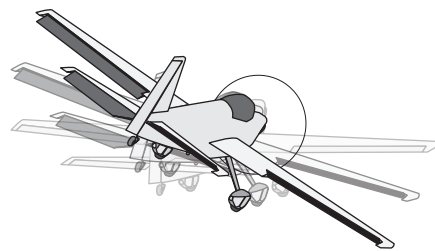



# Acceleration

[Corresponding model type]: Glider, general

Acceleration setting can be performed at Elevator, Elevator → Camber and Aileron → Rudder. (Glider only)

- This setting is divided into elevator setting and camber setting. The setting method is the same.
- Camber setting sets the acceleration function for Ele to camber mixing. Setting is not performed when Ele to camber mixing is INH.
- The acceleration function can be set for both the up side and down side.
- Function ON/OFF switch setting is performed for Aileron→ Rudder setting only.
- Aileron→ Rudder setting is acceleration function setting for Aileron→ Rudder mixing. It is not performed when Aileron→ Rudder mixing is INH.

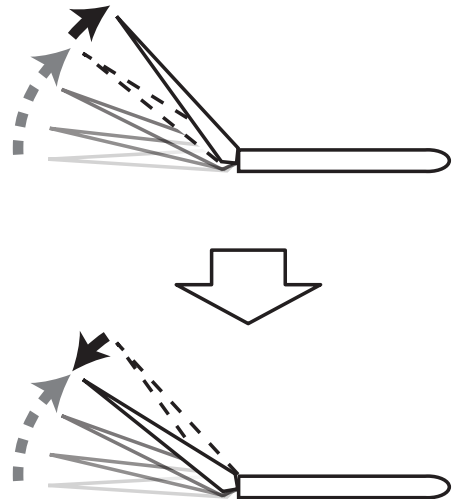

- Select [Acceleration] at the model menu and call the setup screen shown below.

**When using this function, Tap [INH]. (ON is displayed.)**

**Condition group/ single mode selection (Gr./Sngl)**

**To next page  
2/3 : Elevator → Camber  
3/3 : Aileron → Rudder**

- Return to Model menu

**The rate the angle increases.**

**Operation up to this range will initiate acceleration.**

**Act position**

**Current position**

**The return time after operation (Damping) can be set.**  
 (First return) 1 ~ 100 (Slow return)  
 (Acceleration doesn't function as 0.)

## Setting method

- Acceleration rate setting (Rate)
- The return time after operation (Damping) can be set.
- The operation point at acceleration and deceleration can be set. When an operation point is exceeded, acceleration is performed.

Note: When using the acceleration function, since the servo stroke is large, make your settings so there is no binding of your linkage.



# Motor

[Corresponding model type]: Airplane/glider, general

This function lets you set the operation speed when the motor of an F5B or other EP glider is started by switch. The operation speed can be set in 2 ranges of slow speed flight and high speed flight (Speed 1/Speed 2). This function can also be operated as a safety function by setting 2 switches.

- The in side and out side operating speeds can be adjusted independently in 2 ranges (Speed 1/Speed 2).
- The boundary between the 2 ranges can be set. (From speed 1 to speed 2)
- Select [Motor] at the model menu and call the setup screen shown below.

- The set operation speed operation can be activated at initial operation only. (1 time operation) However, operation can be repeated by setting the switch to OFF before operation is finished. When you want to reset 1 time operation, set the ACT/INH item to [INH] and then reset it to [ON].
- The motor (CH3) is controlled by SW-G. (Initial setting) When changing the switch or stick which controls the motor, first change Function of the Linkage menu.

**Note: When using this function, always check initial operation with the propeller removed.**

•Return to Model menu →

Motor Model1 Condit1 6.7V

Status INH ACT/INH INH

Group Gr. One time INH

Switch -- Speed1 → 2 +0

Motor off +0 Speed 1 In Out 0 0

Speed 2 0 0

- When using this function, Tap [INH].
- Group/single mode switching (For more information, see the description at the back of this manual.)
- Switch  
A switch that turns the function itself ON/OFF can be selected.
- Motor off position  
Tap the motor off button when [SW-G] is in the motor OFF position you want to set. The direction of the motor switch is memorized. The screen graph display OFF direction also changes.

- When using this function, Tap [INH].
- When you want to set the "One time mode", tap to the [One time] item and tap the screen.
- Speed 1 to 2  
The speed 1 and speed 2 region boundary can be changed,
- Operation speed adjustment  
The speed when speed 1 and speed 2 are ON (In) and OFF (Out) can be adjusted.

## Notes

- First decide the motor OFF direction, and then set the speed. When you want to reset the motor OFF direction, also reset the speed.
- We recommend that motor OFF be set in combination with F/S.
- Set the basic operation direction with the reverse function to match the ESC used.
- Always set the motor OFF position.



# V-Tail

[Corresponding model type]: Airplane/glider, Tail type V-tail

This function lets you adjust for left and right rudder angle changes at elevator and rudder operation of a V-tail airplane.

V-tail is when 2 servos are used together to control rudder movement as elevators. In addition to each rudder side moving up and down together, each side moves in opposite directions when moving as elevators. On a V-tail, this is also known as a ruddervator, as they can serve the same purpose.

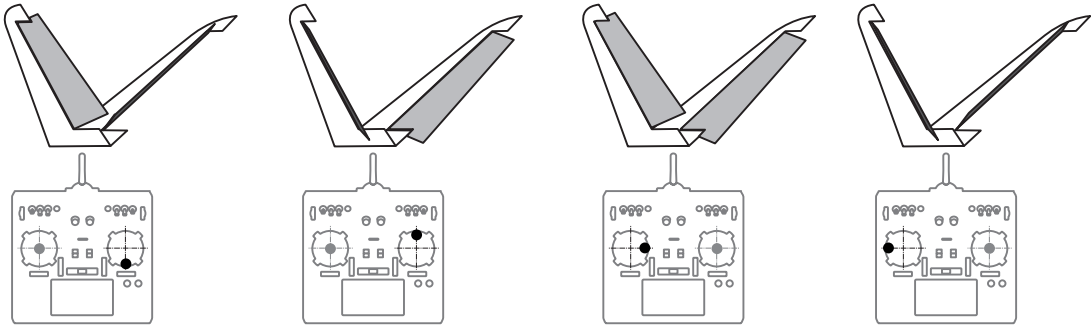
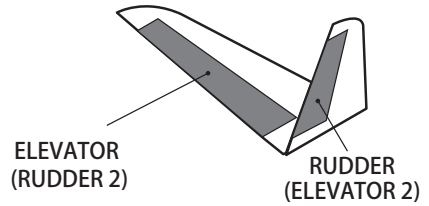

- Select [V-Tail] at the model menu and call the setup screen shown below.

• Return to Model menu

V-Tail Model1 Condit1 6.7V

Group

	Elevator		Rudder	
	Down	Up	Left	Right
Elevator (Rudder 2)	+50	+50	+50	+50
Rudder (Elevator 2)	+50	+50	+50	+50

**(Elevator function)**  
Up and down travel adjustment at CH1 and CH2 elevator operation

**(Rudder function)**  
Left and right travel adjustment at CH1 and CH2 rudder operation

Condition group/  
single mode  
selection (Gr. /Sngl)

- Travel adjustment  
Tap to the item you want to adjust.  
Adjust the rate using the "▼▼" "▼" "▲" "▲▲" buttons.
- \*If the mixing direction is reversed by the linkage, adjustments can be made by changing the mixing rate polarity (+ or -).
- \*If a large value of travel is specified, when the sticks are moved at the same time, the controls may bind or run out of travel. Decrease the travel until no binding occurs.



# Winglet

[Corresponding model type]: Airplane/glider, winglet(2RUD)

This function adjusts the left and right rudder angles of airplanes with winglets.

Winglets are used to improve the efficiency of aircraft lowering the lift-induced drag caused by wingtip vortices. The winglet is a vertical or angled extension at the tips of each wing.

Winglets work by increasing the effective aspect ratio wing without adding greatly to the structural stress and hence necessary weight of its structure - an extension of wing span would also permit lowering of induced drag, though it would cause parasitic drag and would require boosting the strength of the wing and hence its weight - there would come a point at which no overall useful saving would be made. A winglet helps to solve this by effectively increasing the aspect ratio without adding to the span of the wing.

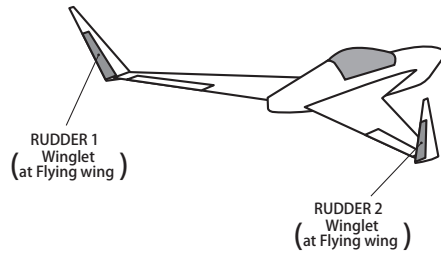

- Select [Winglet] at the model menu and call the setup screen shown below.

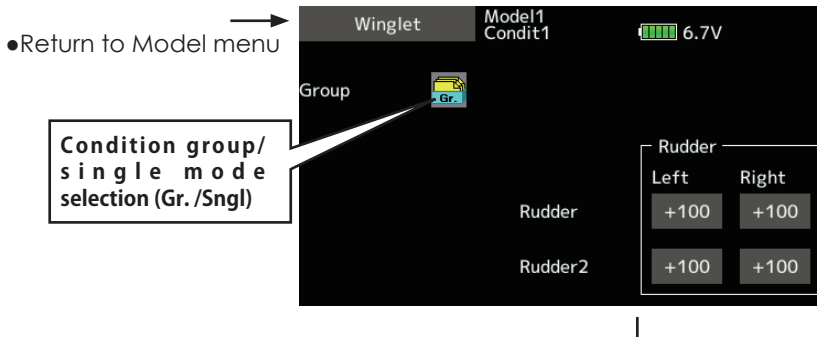

**(Rudder 1/2)**  
The travel at rudder stick left and right operation can be individually set.

- Travel adjustment  
Tap to the item you want to adjust.  
Adjust the rate using the "▼▼" "▼" "▲" "▲▲" buttons.
- \*If the mixing direction is reversed by the linkage, adjustments can be made by changing the mixing rate polarity (+ or -).



## MODEL MENU (Helicopter functions)

This section contains information on the commands that apply to helicopters only. For instructions on airplane, glider and multicopter, refer to the sections pertaining to those aircraft.

Use the Model type function in the Linkage menu to select the swash type matched to the fuselage beforehand.

Also, add flight conditions at the Condition Select screen if necessary before setting the model data at each function. (Up to 8 conditions can be used)

The AFR function, dual rate function and other functions common to all model types, are described in a separate section.

### ◆ Condition hold

When performing adjustments, such as idling up, when the engine is engaged, keep the throttle stable so as to prevent the engine from revving too high. Once your adjustments are complete, always make sure to set the function to [OFF].

#### ⚠ WARNING

**!** For safety reasons, when performing individual adjustments it is recommended that you shut off the engine and disconnect the motor to prevent rotation.

\*Sudden, abrupt rotation can result in death or serious injury.

\*Condition hold ON/OFF operation is possible under normal conditions and the throttle stick is more than 1/3rd into the slow throttle range. Throttle servos will remain at the throttle stick position during ON operation.

### ● ON/OFF operation on the Home screen

Under the conditions described above, tap the Condition hold [OFF] displayed on the screen.

During function operation, Condition hold will display [ON] and an alarm will sound.

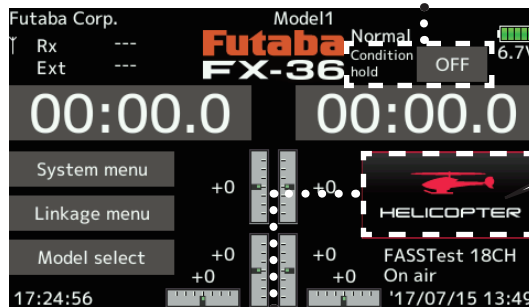

Tap this icon to go to the model menu.

- Select the function name and return to the Home screen.

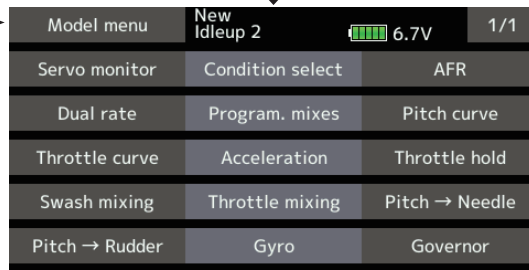

(Model menu screen example)

\* The Model menu screen depends on the model type.

## Model menu (Helicopter) functions table

**Pitch curve:** Pitch curve and hovering trim adjustment

**Throttle curve:** Throttle curve and hovering trim adjustment

**Acceleration:** Allows a brief "overload" in response to sudden throttle and pitch commands

**Throttle hold:** Moves the throttle to idle during autorotation

**Swash mixing:** Compensates for each control response

**Throttle mixing:** Compensates for power loss when cyclic applied

**Pitch→Needle:** Adjusts response curve in different flight conditions

**Pitch→Rudder:** Handles torque changes from pitch angle inputs

**Gyro:** Used to switch gyro sensitivity

**Governor:** Used to switch RPM of the helicopter's head



# Pitch curve / Pitch trim

## Pitch curve

This function adjusts the pitch operation curve for each flight condition for the optimal flight state relative to movement of the throttle stick.

\*Up to 17 points can be set for the point curve types. However, when using the 3 points or 5 points specified to create a curve, a simple curve can be created by reducing the number of input points to 3 or 5, and then entering the specified value at the corresponding points that you created a curve.

- Select [Pitch curve] at the model menu and call the setup screen shown below.
- Return to Model menu

**Currently selected condition name**

● **Mixing curve setting**  
 \*For a description of the curve setting method, see the description at the back of this manual.

Point curve type is 9 points (initial), but for simple use, 4~5 points are sufficient.

### Normal curve adjustment

- For normal curve, usually use [Point] type and create a basic pitch curve centered about hovering. Use this function together with the THR curve (normal) function and adjust the curve so that up/down control is best at a constant engine speed.

### Idle up curve adjustment

- For the high side pitch curve, set the maximum pitch which does overload the engine. For the low side pitch curve, create curves matched to loop, roll, 3D, and other purposes and use the idle up curves according to the performance.

### Throttle hold curve adjustment

- The throttle hold curve is used when executing auto rotation dives.

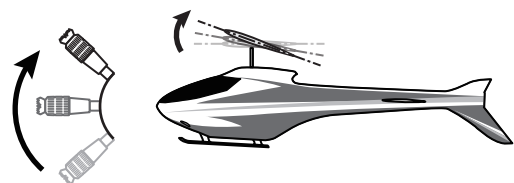

## Operation precautions

### ⚠ WARNING

- ❗ When actually starting the engine and flying, always set the idle up condition switch to OFF and start the engine in the idling state.



## Setting method

- **Group/Single item:** When you also want to input the same setting contents at other conditions, perform setting in the group mode. In this case, the same contents are input to the other conditions set in the group mode. When you want to set each condition independently, select the single mode (initial setting). Other conditions can be set independently.

## Curve setting examples

The screens shown below are curves created by entering the pitch rate at low, center, and high side (3 points or 5 points) at each condition. When actually creating a curve, input the rate specified at the fuselage (or the reference value).

\*For a description of the curve setting method, see the description at the back of this manual.

### •Pitch Curve (Example)

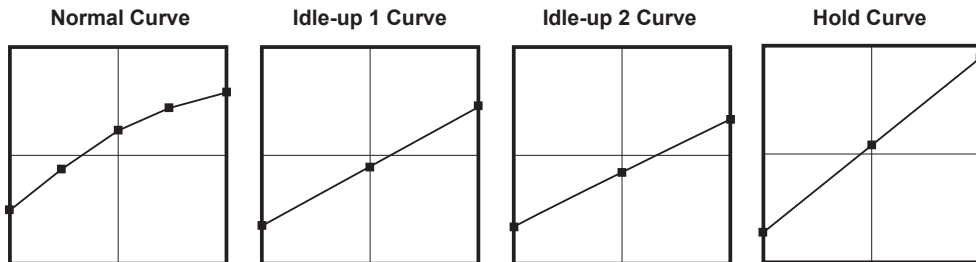

**Pitch servo speed setting**  
(For a description of the setting method, see the description at the back of this manual.)





## Pitch trim (Hovering pitch, high pitch, low pitch)

The hovering pitch, low pitch, and high pitch trim setup screen can be called from the Pitch curve setup screen.

- Return to Model menu

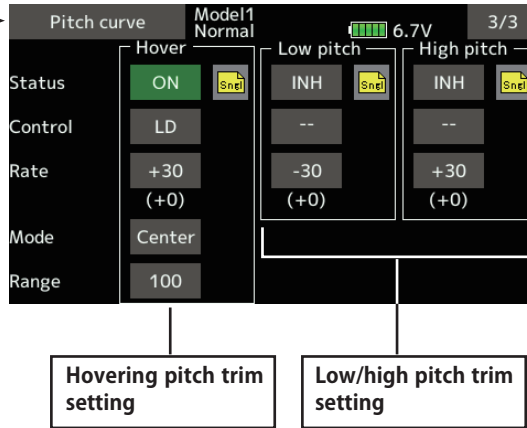

### Hovering pitch trim

The Hovering Pitch trim function trims the pitch near the hovering point. Normally, it is used with the hovering condition. The hovering pitch can be fine tuned for changes in rotor speed accompanying changes in temperature, humidity, and other flight conditions. Adjust the hovering pitch so that rotor speed is constant. This function can be used together with the hovering Throttle Trim function for more delicate operation.

#### Setting method

- When using only the hovering (normal) condition, switch the group mode to the single mode (initial setting) before setting.
- Tap [INH]. (ON is displayed.)
- Select the adjustment knob.  
Selection example: LD
- The trim operation mode (Mode: Center/Normal) can be selected.  
Center mode: Maximum amount of change near center by center trim operation (recommended)  
Normal mode: Normal trim (parallel movement trim) operation. The advantage of using this mode is that the hovering pitch can be adjusted without changing the curve.
- Trim adjustment range (Range) setting  
When this value is made small, trim can only be used near the center.
- The trim rate can be adjusted and the operation direction can be changed.

### High Pitch/Low Pitch Trim

High Pitch/Low Pitch Trim is the pitch servo high side and low side trim function.

#### Setting method

- When setting the adjustment knobs common to all the conditions, set them in the group mode.
- Tap [INH]. (ON is displayed.)
- Select the adjustment knobs.  
Selection example: LS (high side), RS (low side)
- The trim rate can be adjusted and the operation direction can be changed.
- Trim acts as high side or low side trim with the center as the standard.



## Throttle curve / Throttle Hover trim

### Throttle curve

This function adjusts the throttle operation curve for each condition for optimum engine speed to throttle stick movement.

Up to 17 curve points can be set for the point curve type. However, when the 5 points and other

- Select [Throttle curve] at the model menu and call the setup screen shown below.

- Return to Model menu

Currently selected condition name

● **Mixing curve setting**  
\*For a description of the curve setting method, see the back of this manual.

**Throttle hover trim operating position (White line)**

Point curve type is 9 points (initial), but for simple use, 4~5 points are sufficient.

### Normal curve adjustment

- Normal curve creates a basic curve centered around hovering. Use it along with the normal pitch curve and adjust so that up/down control at a constant engine speed is easiest.

### Idle up curve adjustment

- Set an idle up curve that maintains a constant speed at all times, even during operation which reduces the pitch performed in flight. Create a curve matched to loop, roll, 3D, or other purposes and the idle up curve according to the performance.

### Setting method

- Group/single item: When you want to simultaneously enter the same settings to other functions, make the settings in the group mode. In this case, the same setting

point data is used, a simple curve can be easily created by reducing the number of input points of the curve to 5 and entering the specified value at the corresponding points.

### Operation precautions

#### ⚠ WARNING

- ❗ When actually starting the engine and flying, always set the idle up condition switch to OFF and start the engine in the idling mode.

contents are entered to the all conditions. When you want to set each condition independently, make the settings after selecting the single mode (Initial setting).



## Curve setting examples

The curves shown below are created by using the point curve type and inputting the data of the 5 points 0% (low side), 25%, 50% (center), 75%, 100% (high side) at each condition. They are

created by reducing the number of points on the line to 5. When actually creating a curve, enter the data specified per the aircraft (or the reference value).

\*For a description of the curve creation method, see the description at the back of this manual.

### ● Throttle Curve (Example)

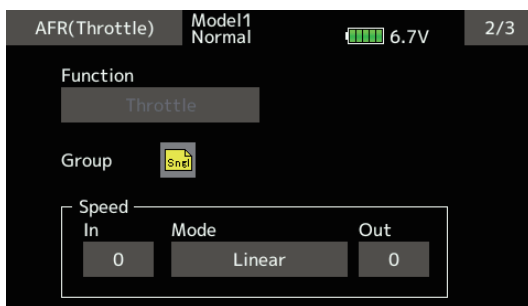
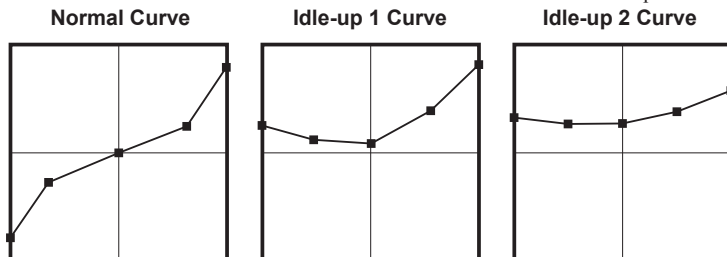

#### Throttle servo speed setting

(For a description of the setting method, see the description at the back of this manual.)

## Throttle Hover trim

The Throttle Hover trim setup screen can be called from the Throttle curve setup screen.

- Return to Model menu

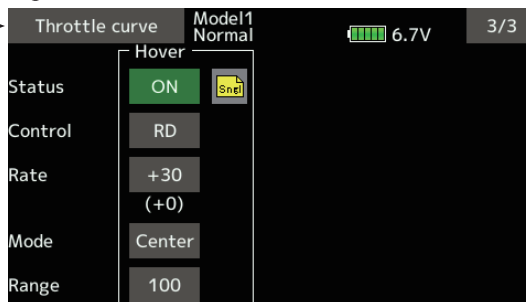

The Throttle Hover function trims the throttle near the hovering point. Normally, use it with hovering conditions. Changes in rotor speed accompanying changes in the temperature, humidity, and other flight conditions can be trimmed. Adjust the throttle so that rotor rotation is most stable. More delicate trimming is also possible by using this function along with the Hover Pitch function.

### Setting method

- When using the hovering (normal) condition only, switch the group mode to the single mode (initial setting) and make the settings.
- Tap [INH]. (ON is displayed.)

- Select the adjustment knob.  
Selection example: RD
- The trim operation mode (Mode: Center/Normal) can be selected.  
Center mode: Maximum rate of change near center by center trim operation (recommended)  
Normal mode: Normal trim (horizontal movement trim) operation.
- Trim adjustment range (Range) setting  
When the value is made small, trim acts only near the center.
- The trim rate can be adjusted and the operation direction can be set.



# Acceleration

This function is used to adjust the pitch and the throttle rise characteristic at acceleration/deceleration operation. An acceleration function which temporarily increases the pitch and throttle operations at throttle stick acceleration/deceleration operation can be set.

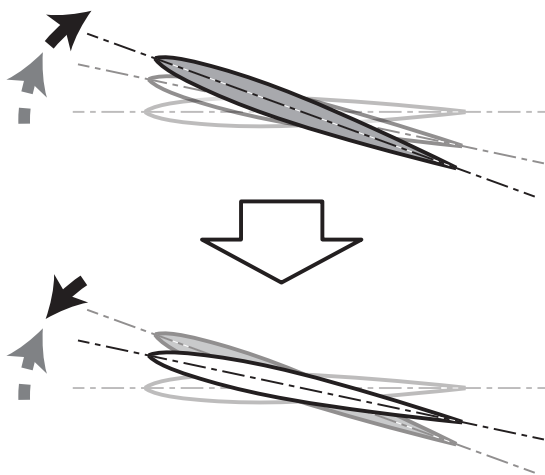

### Example of acceleration function use

- When used at pitch, the acceleration function is effective when you want to quicken the response of the fuselage at 3D flight flip, etc.  
When used, high pitch temporarily exceeds maximum pitch, but immediately returns to maximum pitch.

- Select [Acceleration] at the model menu and call the setup screen shown below.

**When using this function, Tap [INH]. (ON is displayed.)**

**Condition group/ single mode selection (Gr./Sngl)**

**To next page  
1/2 : Pitch  
2/2 : Throttle**

**Operation up to this range will initiate acceleration.**

**Act position**

**Current position**

• Return to Model menu →

**The rate the angle increases.**

**The return time after operation (Damping) can be set.**  
(First return) 1 ~ 100 (Slow return)  
(Acceleration doesn't function as 0.)

### Setting method

- Acceleration can be set at both setting at acceleration (high) and setting at deceleration (low).  
(The operation point is displayed on a graph.)
- Acceleration rate setting (Rate)
- The return time after operation (Damping) can be set.

- The operation point at acceleration and deceleration can be set. When an operation point is exceeded, acceleration is performed.

Note: When using the acceleration function, since the pitch stroke is large, make your settings so there is no binding of your linkage.



# Throttle hold

This function sets the throttle cut position for autorotation. The throttle position can also be set to an idling position. Setting of these 2 positions can be selected by switch. This allows use for switching during training.

- Select [Throttle hold] at the model menu and call the setup screen shown below.

• Return to Model menu

Throttle hold		Model1
Cut mode		Normal
Status	INH	[Snel]
Switch	--	
Hold pos.	17	
Speed	0	
Mode	Manual	
Auto pos.	50	

**Engine cut setting**

Idle mode		6.7V
Status	INH	[Snel]
Switch	--	
Hold pos.	50	
Speed	0	
Mode	Manual	
Auto pos.	50	

**Engine idle setting**

Annotations:   
 - Current position (points to 17 in Cut mode)   
 - Set to the engine stop position. (points to the red arrow on the slider)   
 - Hold position (points to the 17 value)   
 - Set to the idling position. (points to 50 in Idle mode)

### Example of use

- Since throttle hold has 2 modes (Cut) and (Idle), using it in the Idling mode during training and in the Cut mode when stopping the engine at contest, etc. is convenient.

Note: When throttle hold is set to ON in the normal condition, throttle hold acts and the throttle servo is deactivated. Always set throttle hold to ON in the hold condition.

## Setting method

- Operation mode selection
  - Manual mode(Manual): The throttle hold function is operated by switch operation only.
  - Auto mode(Auto): The throttle hold operation is linked to the throttle stick position.
  - Auto position setting: When the auto mode is selected, the throttle position (auto position) can be selected. Move the throttle stick to the position you want to set and tap the screen. (Auto position is displayed.)
- Hold position adjustment
  - Throttle Hold (Cut) sets the throttle cut position. Adjust it so that the carburetor is fully closed.
  - Throttle Hold (Idle): Make this adjustment to maintain idling for training. Adjustments can be made based on the throttle curve idle position.
- The throttle servo operating speed can be adjusted. (Speed)
- Throttle cut or training function can be switched by hold function selector switch.

## Operation precautions

**⚠ WARNING**

**❗ When starting the engine, confirm that the idle up condition and throttle hold condition are OFF.**

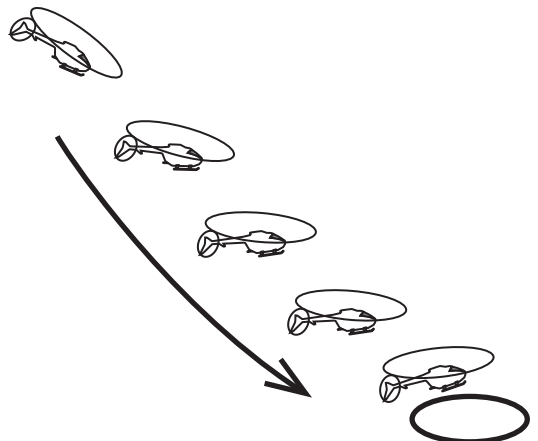



# Swash mixing

The swash mix function is used to correct the swash plate in the aileron (roll) direction and elevator (cyclic pitch) corresponding to each operation of each condition.

Adjustment by independent curve for aileron, elevator, and pitch operations is possible. The operation can be smoothly adjusted by calling up the “Curve setup” screen by tapping the mixing item that corresponds to the mixing and direction which needs correction.

**Example of use**

- As an example, use swash mixing to correct undesirable tendencies in the roll direction.
- For a condition which uses Aileron to Elevator, set this function to ON. When raising the nose at a right roll, when the Rate B side is input and the right aileron is operated, the elevator moves to the down side. Tune by adjusting the Rate. For right roll, adjust to the rate A side.

- Select [Swash mixing] at the model menu and call the setup screen shown below.

Mixing	Status	Switch	Trim	
Aileron → Elevator	INH	--	OFF	Snel
Elevator → Aileron	INH	--	OFF	Snel
Pitch → Aileron	INH	--		Snel
Pitch → Elevator	INH	--		Snel

- Return to Model menu

**● Mixing curve setting**  
 \*For a description of the curve setting method, see the description at the back of this manual.

## Setting method

- When using this function, Tap [INH]. (ON is displayed.)
- When you want to set the same contents at other conditions, select the group mode. When you want to set the selected condition only, select the single mode (initial setting).
- The correction rate can be set by curve.
- A switch can be set.

When [--] is set, the swash mixing function is operated by merely selecting the condition. When setting an [ON]/[OFF] switch, tap to the [--] item and tap the screen to call the selection screen and set the switch and its ON position.



# Throttle mixing

This function corrects slowing of engine speed caused by swash plate operation during aileron or elevator operation. The method of applying clockwise or counterclockwise torque when pirouetting can also be corrected.

An acceleration function which temporarily increases the throttle side correction rate relative to rapid stick operation can also be set.

- Select [Throttle mixing] at the model menu and call the setup screen shown below.
- Return to Model menu



"CTRM" : The correction rate maximum when the throttle stick is centered.  
 "Linear" : Correction applied for the entire throttle range.

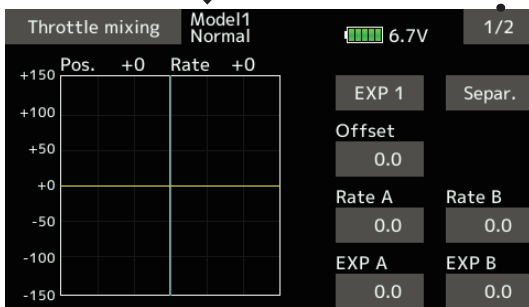

● **Mixing curve setting**  
 \*For a description of the curve setting method, see the description at the back of this manual.



**<Acceleration function setting>**

- Acceleration can be set for both settings (Left) and (Right)
- Acceleration rate setting (Rate)
- The return time (Damping) after operation can be set.
- The operation point (Act position) when the correction rate is increased and decreased can be set independently. When an operation point is exceeded, acceleration operation is performed.

## Setting method

- When using this function, Tap [INH]. (ON is displayed.)
- When you want to set the same contents at other conditions, select the group mode.  
 When you want to set the selected condition only, select the single mode (initial setting).
- The correction rate can be set by curve.
- A switch can be set.

When [--] is set, the swash mixing function is operated by merely selecting the condition.

When setting an [ON]/[OFF] switch, tap to the [--] item and tap the screen to call the selection screen and set the switch and its ON position.

When correction is necessary, tap to the mixing item corresponding to the mixing that needs correction and tap the screen to call the curve setup screen, and then correct the slowing.

**Setting example**

- Aileron to Throttle applies a load to the engine and corrects slowing of the engine speed when the aileron stick was operated. Engine racing can be adjusted independently at the right aileron and left aileron by Rates A and B.



## Pitch → Needle

This mixing is used when the engine is equipped with needle control or other fuel-air mixture adjustment. A needle curve can be set.

An acceleration function which temporarily increases needle operation at throttle stick

acceleration/deceleration operation can be set. The rise characteristic of the needle servo at acceleration and deceleration operation can be adjusted.

- Select [Pitch→Needle] at the model menu and call the setup screen shown below.

- Return to Model menu

### ● Mixing curve setting

\*For a description of the curve setting method, see the description at the back of this manual.



Normally, use [Point] type.

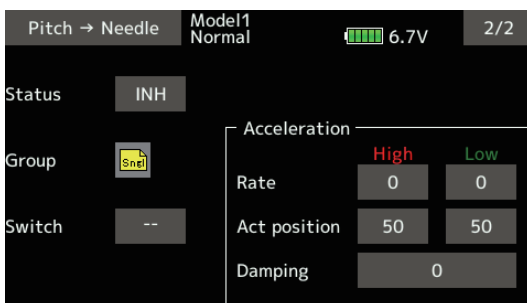

### Setting method

- When using this function, Tap [INH]. (ON is displayed.)
- When you want to set the same contents at other conditions, select the group mode. When you want to set the selected condition only, select the single mode (initial setting).
- A needle curve can be set.
- A switch can be set.

When [--] is set, the mixing function is operated by merely selecting the condition.

When setting an [ON]/[OFF] switch, tap to the [--] item. Tap the screen to call the selection screen and set the switch and its ON position.

### < Acceleration function setting >

- Acceleration can be set at both acceleration (high) and deceleration (low).
- The acceleration rate (rate) and the return time after operation (damping) can be set.
- An operation point (Act position) at acceleration and deceleration can be set. When an operation point was exceeded, acceleration operation is performed.





## Pitch → Rudder (Revolution mixing)

Use this mix when you want to suppress the reaction torque generated by main rotor pitch and speed changes during pitch operation. Adjust so that the nose does not move in the rudder direction.

An acceleration function which temporarily increases the correction rate at throttle stick acceleration/deceleration operation can be set. The mixing rate at acceleration/deceleration can be set.

- Select [Pitch→Rudder] at the model menu and call the setup screen shown.

● **Mixing curve setting**  
 \*For a description of the curve setting method, see the description at the back of this manual.



### Setting method

- When using this function, Tap [INH]. (ON is displayed.)
- When you want to set the same contents at other conditions, select the group mode.  
 When you want to set the selected condition only, select the single mode (initial setting).
- A mixing curve is set.

However, when a GY Series or other heading hold gyro is used, since correction is performed by the gyro, this mix is not used. If this function is used when the gyro operation mode is the AVCS mode, the neutral position will change.

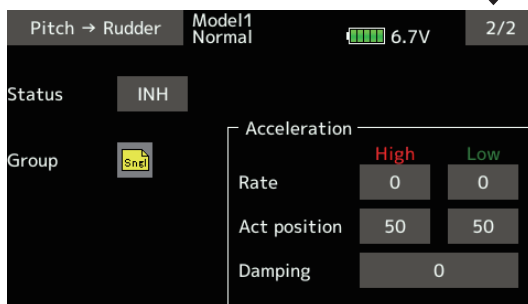

#### <Normal condition mixing curve>

The mixing curve rate starts from a small value.

For a rotor with a clockwise operation direction (polarity), when pitch was operated at the plus side, set so that mixing is in the clockwise direction. First, trim at hovering and then adjust the neutral position.

1. Adjustment between slow and hovering  
 Repeatedly hover from take off and land from hovering at a constant rate matched to your own rhythm, and adjust the pitch so the nose does not deflect when the throttle is raised and lowered.
2. Throttle high side (climbing and diving from hovering)  
 Repeat climbing and diving from hovering at a constant rate matched to your own rhythm and adjust the pitch so that the nose does not deflect when the throttle is raised and lowered.

#### <Idle up condition mixing curve>

Set the mixing rate so that the rudder direction at high-speed flight is straight ahead. Adjust for each condition used.

#### <Acceleration function setting>

- Acceleration operation can be performed for both setting at acceleration (High) and setting at deceleration (Low).
- Acceleration rate setting (Rate)
- The return time after operation (Damping) can be set.
- An operation point (Act position) at acceleration and deceleration can be set independently. When an operation point was exceeded, acceleration operation is performed.



# Gyro [Helicopter]

This function is used to adjust gyro sensitivity. The sensitivity and operation mode (Normal mode/AVCS mode) can be set for each condition.

The gyro sensitivity can be switched with each condition or the switch. (3 sensitivities)

\*Compatible with 3 axis gyro (CGY750).

Note: [Gyro] [Gyro2] [Gyro3] Default function  
 [Gyro]: **CH6**(FASSTest12CH) **CH5**(Other system type)  
 [Gyro2] : **CH9**  
 [Gyro3] : **CH10**

Always set to [--] both (control) and (trim) for the [Gyro] function at the Function menu in the Linkage menu.

- Select [Gyro] at the model menu and call the setup screen.

- Return to Model menu

The operation mode (AVCS/NOR) and sensitivity of the 3 axes Gyro/Gyro2/Gyro3 can be set.

	Gyro (RUD) setting		Gyro2 (AIL) setting		Gyro3 (ELE) setting	
Gyro	Model1 Normal		6.7V			
	Gyro(RUD)		Gyro2(AIL)		Gyro3(ELE)	
Rate 1	Normal	80	Normal	50	Normal	50
	ON	(80)	ON	(50)	ON	(50)
Rate 2	Normal	80	Normal	50	Normal	50
	INH	(80)	INH	(50)	INH	(50)
Rate 3	Normal	80	Normal	50	Normal	50
	INH	(80)	INH	(50)	INH	(50)

Tapping these will pull up the detailed selection screen for each.

Rate1 Gyro type and gain

Rate2 Gyro type and gain

Rate3 Gyro type and gain

When using Rate2/Rate3, make it INH → ON or OFF.

Use this when you want to adjust sensitivity via VR, etc., and not on-screen data entry. Tap "--", select "VR", etc., and then tap the value to adjust. (Won't operate when value is "0".)

	Gyro(RUD)		Gyro2(AIL)		Gyro3(ELE)	
Rate 1	ON	Sngl	INH	Sngl	INH	Sngl
	GY	--	GY	--	GY	--
Rate	Normal	80	Normal	80	Normal	80
		(80)		(80)		(80)
Fine tuning	--	+0	--	+0	--	+0
		(+0)		(+0)		(+0)

Condition group/single mode selection (Gr./Sngl)

The ON/OFF switch of gyro is chosen.

3 rate (gyro gain) adjustment

## Setting method

- When using this function, Tap [INH]. (ON is displayed.)
- When you want to set the same contents at other conditions, select the group mode.  
 When you want to set the selected condition only, select the single mode (initial setting).
- Three rates can be switched for each condition. (Rate1/Rate2/Rate3)
- A fine tuning VR can be set.



### Usage example #1: Using gyro for only the rudder and adjusting sensitivity for each condition

\* Gyro gain channel

Gyro : CH5

For the FASSTest12CH, Gyro/RUD is 6ch. The gyro sensitivity adjustment connector connects to 6ch.

- Select [Gyro] at the model menu and call the setup screen.

Tapping here will let you select either Normal or AVCS.

This is all that is needed for use in this case.

Set gain of a rudder

	Gyro	Mod Normal	6.7V			
	Gyro(RUD)	Gyro2(AIL)	Gyro3(ELE)			
Rate 1	Normal	80	Normal	50	Normal	50
	ON	(80)	ON	(50)	ON	(50)
		80	Normal	50	Normal	50
		(80)	INH	(50)	INH	(50)
Rate 3	Normal	80	Normal	50	Normal	50
	INH	(80)	INH	(50)	INH	(50)

Because the sensitivity is switched (Sngl) per condition, Rate2 and Rate3 are not used.

Because sensitivity changes for hovering and idleup, perform switchover for each condition and adjust sensitivity.

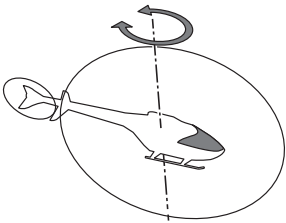

### Usage example #2: Using 3-axis gyro CGY750 and adjusting sensitivity for each condition

\* Gyro gain channel

Gyro RUD : CH5 For the FASSTest12CH, Gyro/RUD is 6ch.

Gyro2 AIL : CH9

Gyro3 ELE : CH10

For the CGY750, simply connect the S.BUS; functions do not need to be set.  
(For the FASSTest12CH, change Gyron/RUD to 6ch.)

- Select [Gyro] at the model menu and call the setup screen.

Tapping here will let you select either Normal or AVCS for each of the three axes.

This is all that is needed for use in this case.

Set gain of a rudder

Set gain of an aileron

Set gain of an elevator

	Gyro	Model1 Normal	6.7V			
	Gyro(RUD)	Gyro2(AIL)	Gyro3(ELE)			
Rate 1	Normal	80	Normal	50	Normal	50
	ON	(80)	ON	(50)	ON	(50)
		80	Normal	50	Normal	50
		(80)	INH	(50)	INH	(50)
Rate 3	Normal	80	Normal	50	Normal	50
	INH	(80)	INH	(50)	INH	(50)

Because the sensitivity is switched (Sngl) per condition, Rate2 and Rate3 are not used.

Because sensitivity changes for hovering and idleup, perform switchover for each condition and adjust sensitivity.

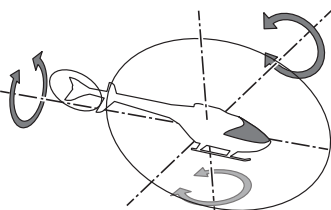



# Governor

When using a Futaba governor, this function is used to switch the RPM of the helicopter's head. Up to 3 rates can be set for each condition.

\*The governor is used by connecting the governor speed setting channel to CH7 (initial setting).

\*When using an independent governor [ON]/[OFF] switch, connect the AUX([ON]/[OFF]) connector of the governor to CH8 (initial setting) and set the switch to CH8 (Governor2) at the Function menu of the Linkage menu.

\*When using the Fuel Mixture function, the mixture servo is controlled from the governor. When transmitting the mixture curve data from the transmitter to the governor, the governor AUX (m.trm) connector must be connected to CH8 (initial setting) and governor side setting performed. See the governor instruction manual.

Note: Always set (Control) and (Trim) to [--] for [Governor] and [Governor2] of the Function menu of the Linkage menu.

- Select [Governor] at the model menu and call the setup screen shown below.

- Return to Model menu

	Rate 1	Rate 2	Rate 3
INH	[INH]	[INH]	[INH]
Rate	50.0 (50.0)	50.0 (50.0)	50.0 (50.0)
Tuning	+0 (+0)	+0 (+0)	+0 (+0)
Unit	%	%	%

Mode: 1000 - 2000 rpm

## Setting method

### •Activate the mixing

When using this function, Tap [INH]. (ON is displayed.)

\*When the function is set ON/OFF at the governor setup screen, the governor rpm setting channel end point servo travel and limit point are now initialized.

\*When changed from INH to ACT (ON), the servo travel is initialized to 100 and the limit point is initialized to 155.

\*When operation is changed to INH at all conditions, the servo travel is initialized to 100 and the limit point is initialized to 135.

### •RPM adjustment

Tap to the rate item .  
Adjust the rpm using the "▼▼" "▼" "▲" "▲▲" buttons.  
Initial value: 50% (1500rpm)  
Adjustment range: OFF, 0~110% (OFF, 700~3500rpm)

\*When the value is tapped reset to the initial value.

### •Unit display selection

Tap to the UNIT item [%] [rpm]. Select the unit.



## ●Display mode selection

- \*When [rpm] mode is selected above setting, the display mode can be selected.
- \*There is no change in the transmitter output even when the "Mode" is changed. Calibration should be performed via the governor.
- \*In order to use the Governor function of the FX-36, it is necessary to change the settings on the governor for the low side 700 rpm mode.

When the Mode of the Governor screen's model menu is changed, the change is also indicated on-screen.

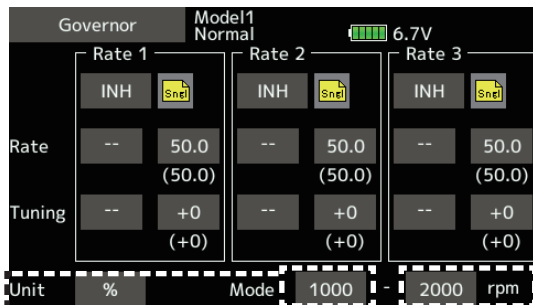

The chart below indicates the mode percentage and the corresponding RPM.

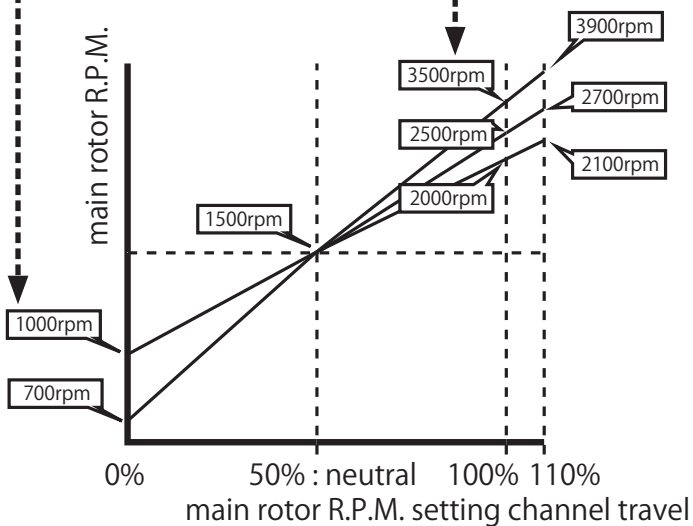

## ●Fine tuning VR settings

Tap to the [--] item and tap the screen to access the selection screen. Select the control.

\*For a description of the switch selection method, see the description at the back of this manual.

Tap to the rate item .

Adjust the trim rate using the "▼▼" "▼" "▲" "▲▲" buttons.

Initial value: 0% (0rpm)

Adjustment range: -20~+20%

\*When the screen is tapped for one second, the sensitivity is reset to the initial value.

Tap the screen to return to the cursor mode.

## Common operations used in function setup screen

This section describes the functions often used at the function setup screen. Refer to it when setting each function.

### Operations value setting

EXP B  
-100.0

Pressing and holding a value will return it to its default setting.

Tapping the value setting buttons on each screen will cause value input buttons to appear at the top of the panel.

Value input buttons display at the top of the panel

Large change in value    Small change in value    Large change in value

### Operations related to flight conditions

#### Group/single mode switching (Gr/Singl)

When setting multiple flight conditions, linking the setting contents with all conditions (group mode) or setting independently (single mode) can be selected. The mode can be changed at the [Gr] item on each setup screen.

[Group/single mode switching]

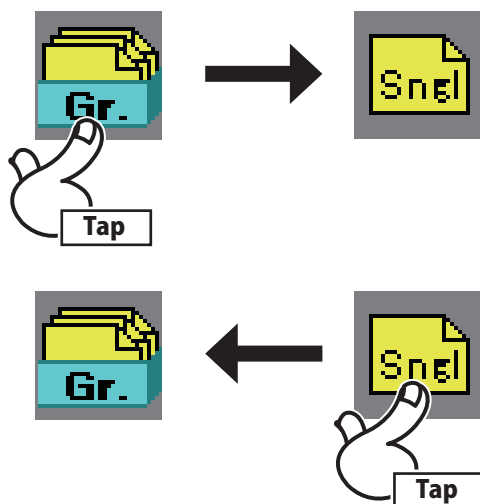

- Group mode (Gr)  
The same setting contents are set to all the flight conditions.
- Single mode (Singl)  
Set this mode when the setting contents are not linked with other conditions.

#### Condition delay setting

Unnecessary fuselage motion generated when there are sudden changes in the servo position and variations in the operating time between channels can be suppressed by using the condition delay function of the condition select function [Condition select].

When the delay function is set at the switching destination condition, a delay corresponding to that amount is applied and the related functions change smoothly.

[Setting method]



1. Switch to the condition you want to set and tap the delay[ 0 (value)].
2. Set the delay using the "▼▼▼" "▼" "▲▲▲" "▲▲" buttons  
Initial value: 0  
Adjustment range: 0~27 (maximum delay)  
(When the value is tapped, the delay is reset to the initial value.)

## Operations related to fine tuning VR

**Operation mode selection**  
 \*The operation modes which can be selected depend on the function.

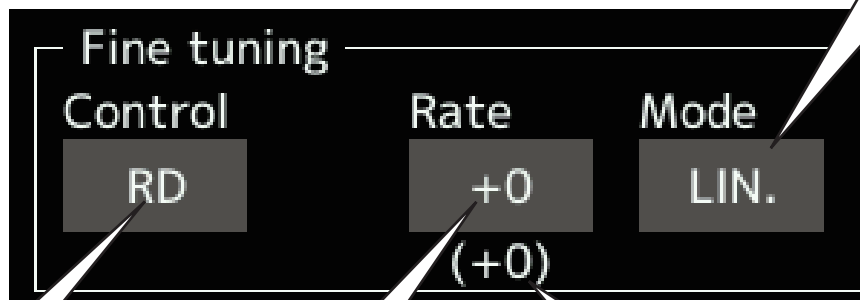

**VR selection**

**Rate adjustment**

**(Fine tuning VR operation position)**

[Setting method]

**1. Control selection**

Tap the [Control] "--" button to call the <Hardware select> screen, and then select the switch and its ON direction.

**2. Mode selection**

Tap the [Mode] button, and then select the mode ([LIN.], [ATL+], [ATL-], or [SYM.]).

**3. Rate adjustment**

Tap the [Rate] "value" button.

Set the rate using the "▼▼" "▼" "▲▲" buttons

Initial value: 0%

Adjustment range: -100%~+100%

(When the value is tapped, the rate is reset to the initial value.)

[Fine tuning VR operation mode]

[LIN.] Mixing rate 0% at center of VR. When the VR is turned clockwise and counterclockwise, the mixing rate increases and decreases, respectively.

[ATL+] Mixing rate 0% at left end of VR. When the VR is turned, the mixing rate increases.

[ATL-] Mixing rate 0% at right end of VR. When the VR is turned, the mixing rate increases.

[SYM.] When the VR is turned to the left or right of the neutral position, the mixing rate increases.



**LIN. ATL+ ATL- SYM.**

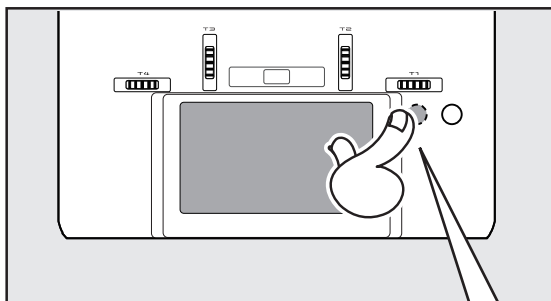

**After setting, press a H/E button**

## Operations related to servo speed

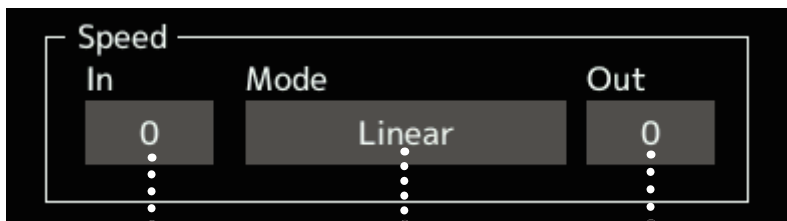

(First) 0 ~ 27 (Slowly)

### Servo speed setting

The servo speed at each function operation (including flight condition switching) can be adjusted. The servos operate smoothly at a fixed speed corresponding to the set speed. The operating speed (In side) and return speed (Out side) can be set individually.

Switch the operation mode according to the set function.

"Symmetry" mode: Used with ailerons and other self neutral functions.

"Linear" mode: Used with functions which hold the operation position of the throttle and switch channel, etc.

[Setting method]

1. Select the mode ([Linear] or [Symmetry]). Each time the button is tapped, it toggles between [Linear] and [Symmetry].
2. Tap the In or Out Speed button and set the servo speed.

Initial value: 0

Setting range: 0~27

### Linear

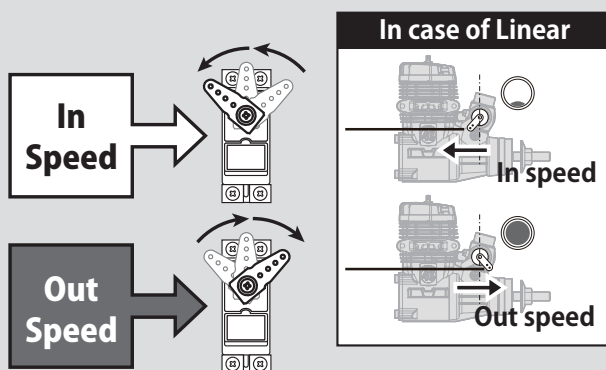

### Symmetry

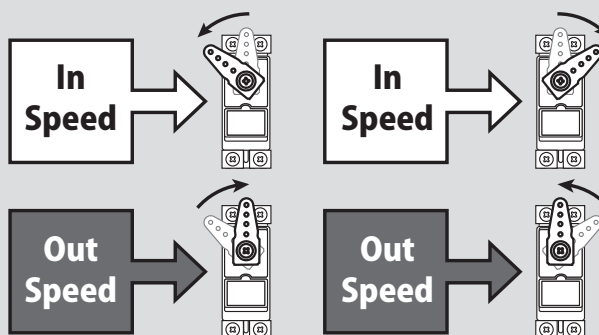

### In case of Symmetry

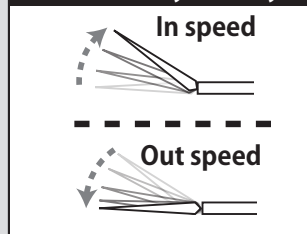



## Curve setting operation

This section describes the setting procedure of curves which are used with the AFR function and each mixing function.

### Curve type selection

Four types of curves (EXP1, EXP2, Point and Spline) can be selected.

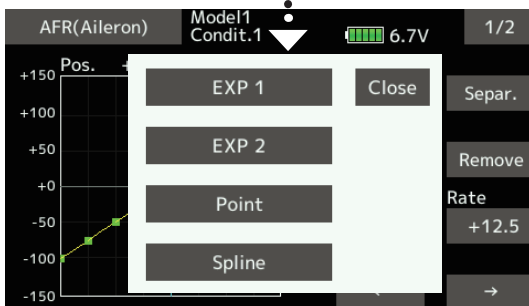
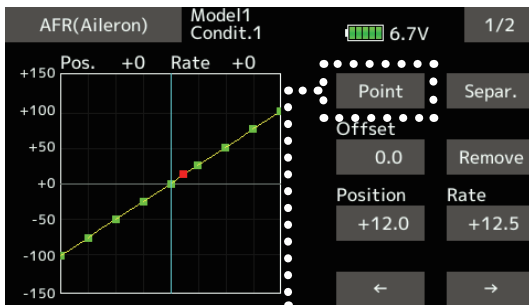

### Curve type selection

1. Tap the button of the curve type you want to use.

\*The curve type changes and the display returns to the original screen.

[EXP1]: EXP1 curve

[EXP2]: EXP2 curve

[Point]: point curve

[Spline]: spline curve

## Setting by curve type

When the curve type is selected as described above, adjustment items corresponding to the curve type appear on the screen. Adjust each curve as described below.

### EXP1/EXP2 curve adjustment

(EXP1 curve)

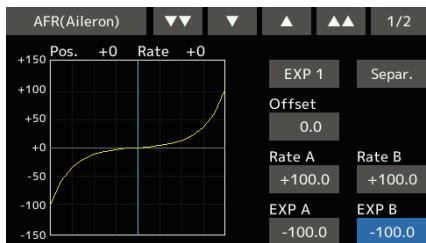

Using the EXP1 curve is effective in smoothing starting of the ailerons, elevator, rudder, etc.

(EXP2 curve)

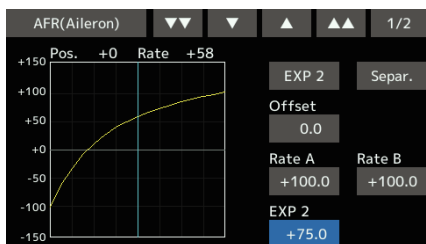

Using the EXP2 curve is effective in engine rise and other engine control.

The curve left and right rates ([Rate A], [Rate B]) and EXP curve rate ([EXP A], [EXP B]) can be adjusted individually. ([EXP] for EXP2)

The curve can also be offset horizontally ([Offset]) in the vertical direction.

[Rate setting]

1. Tap to the [Rate A], [Rate B], [EXP A], or [EXP B] setting item.
2. Set the rate using the "▼▼" "▼" "▲" "▲▲" buttons

Initial value: +100.0% (rate)/+0.0% (EXP rate)

\*Initial value differs depending on function.

Adjustment range: -200.0~+200.0% (rate)/-100.0~+100.0% (EXP rate)

(When the value is tapped, the rate is reset to the initial value.)

[Offsetting the curve horizontally in the

vertical direction]

1. Tap to the [Offset] setting item.
2. Move the curve in the vertical direction using the "▼▼" "▼" "▲" "▲▲" buttons

Initial value: +0.0%

(When the value is tapped, the rate is reset to the initial value.)

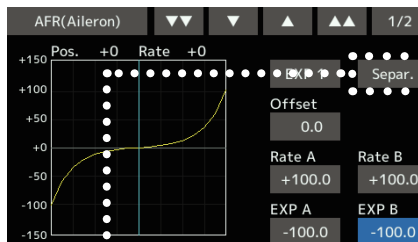

\*[Separ.] mode: Normal setting

\*[Comb.] mode: Creates a left and right symmetrical curve.

Point curves or spline curves of up to 11/17 points can be used. (Initial value: 7/9 points) **The set points can be freely increased, decreased, and offset.**

### Point addition method

1. Open the screen of a mixing curve with the curve function.

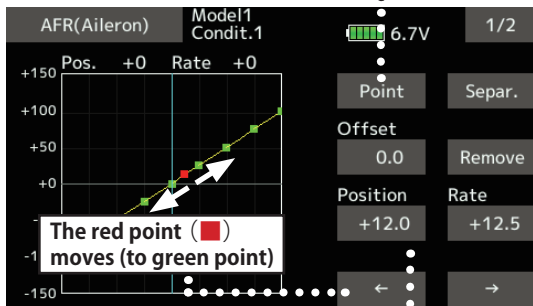
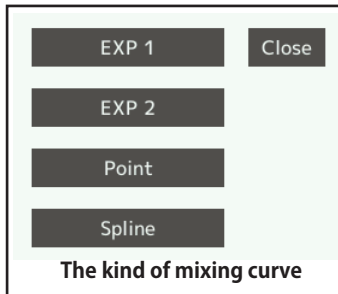

2. Tap the "Position" button.

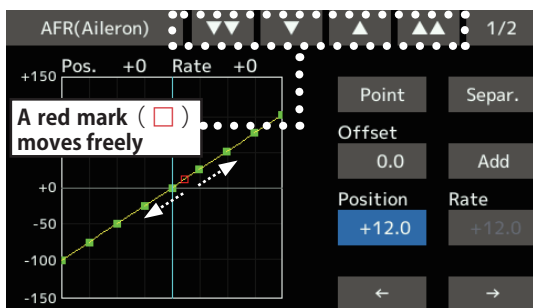

3. Tap the "▼▼" "▼" "▲" "▲▲" button and select the position (mark □) you want to add.

4. When the "Add" is tapped, the point is added. (□) → (■)

\*A new point is created.

5. Press "Rate" and use the up/down arrows to adjust the rate points up or down.

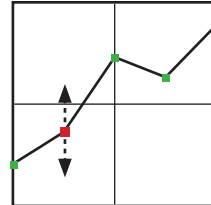

### Point deletion method

1. Use the move between points button [← ] or [→ ] and select the point. (The red point ■ is the selected point.)

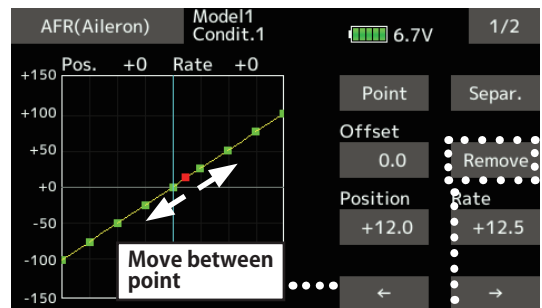

2. Tap the [Remove] button. (The selected point becomes an outlined point □)

3. Use the move between points button [← ] or [→ ].

### Curve setting operation Spline curve

A smoother curve is made.  
Setting method is same at spline and point.

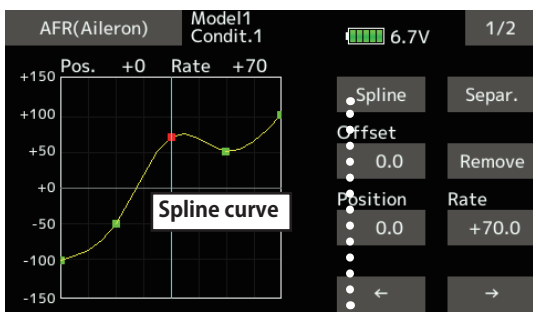
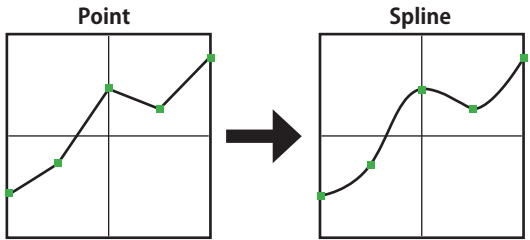

EXP 1 Close

EXP 2

Point

Spline

The kind of mixing curve

Up to 11 or 17 points curve can be used.  
(differs with function)

Initial point number: 9 points (17 points curve), 7 points (11 points curve)

\*The set points can be freely increased, decreased, and offset.

[Rate adjustment of each point]

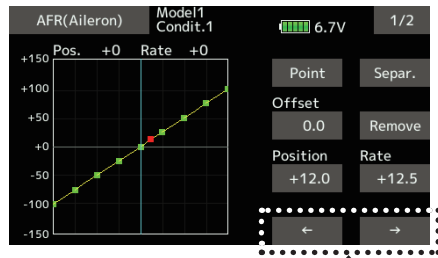

1. Tap to the ← → item and select the point whose rate you want to set.

\*The mark ■ on the curve shows the currently selected point.

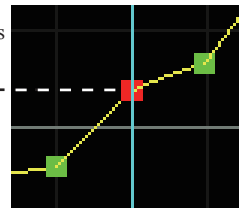

2. Tap to the [Rate] item. And set the rate using the "▼▼" "▼" "▲" "▲▲" buttons

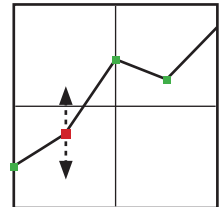

Repeat steps 1 through 2 and adjust the curve.

### Point curve (Point) adjustment

(Point)

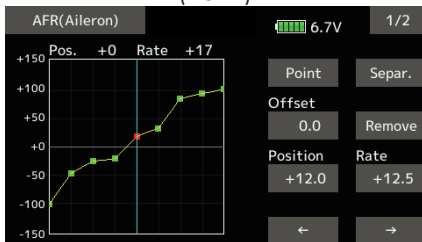

Up to 11 or 17 points curve can be used. (differs with function)

Initial point number: 9 points (17 points curve), 7 points (11 points curve)

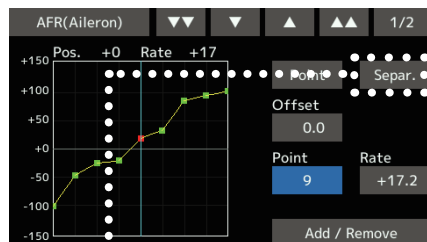

\*[Separ.] mode: Normal setting

\*[Comb.] mode: Creates a left and right symmetrical curve.

## Switch selection method

The various functions used in the FX-36 can be selected by switch. The switch (including when stick, trim lever, or VR are used as a switch) setting method is common to all functions.

### Switch selection

When a switch is selected at a mixing function, etc., the selection screen shown below is called.

(Switch selection screen example)

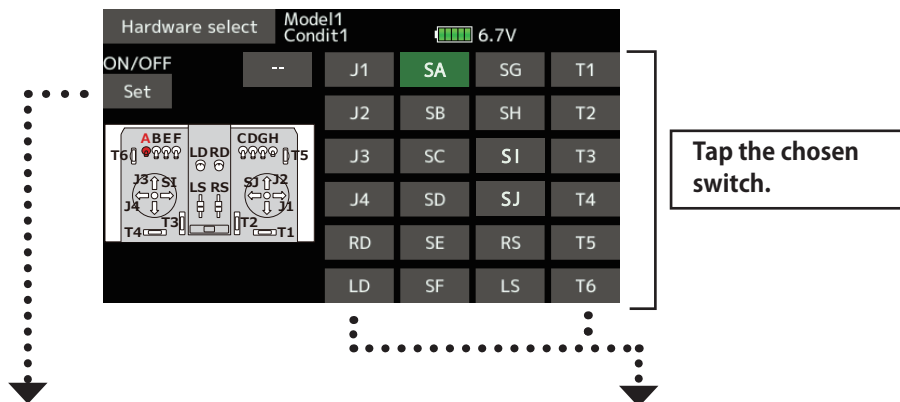

#### When switch is selected

Switch ON/OFF setting is possible at each position.

1. When the ON/OFF "Set" position switch is tapped after the switch was selected, the screen shown below appears.

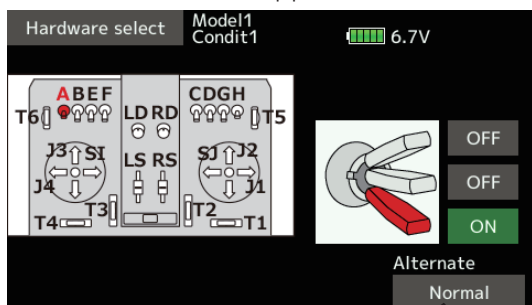

**Normal or Alternate: Alternate switching mode is available depending on mixing function.**

#### When stick, trim lever, or VR is selected.

When a stick, trim lever, or VR is used as a switch, the following 4 modes can be selected.

⋮  
↓  
Next page

\*When the button of each position is tapped, it toggles between ON and OFF.

2. Tap the button and set to the ON position.
3. Close the screen by tapping [Hardware select].

**Hysteresis-type and box-type can be selected in a hardware select screen.**

When a stick, trim lever, or VR is used as a switch, the following 4 modes can be selected.

**◆ Linear • Hysteresis mode**

This setting method selects function ON/OFF based on the set point. Hysteresis (dead band) can be set to ON and OFF. The ON and OFF positions can be reversed with the Reverse button.

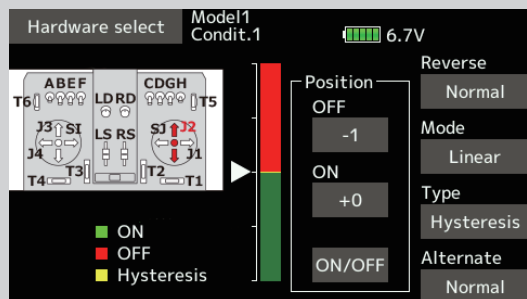

**◆ Symmetry • Hysteresis mode**

The operation is the same as the linear hysteresis mode, but left and right (up and down) operations are symmetrical about the neutral position. For example, when you want to switch DR1 with the aileron stick, when the stick is moved to the left or right, DR1 can be turned ON at the same left and right position.

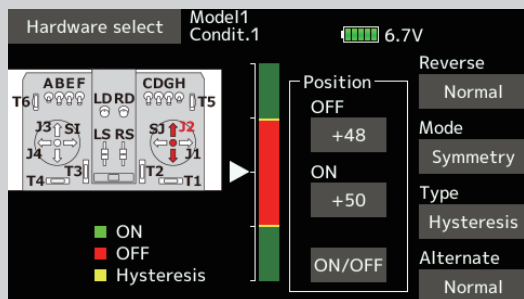

**◆ Linear • Box mode**

This mode turns on the switch within a range of 2 points. Each point can be set. The ON and OFF positions can be reversed with the Reverse switch.

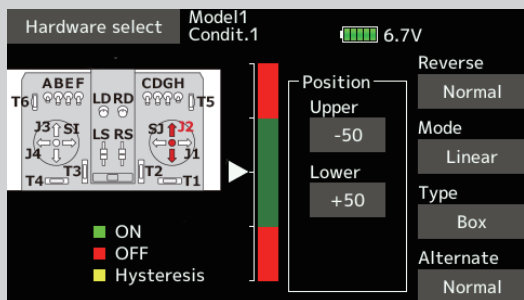

**◆ Symmetry • Box mode**

The operation is the same as the linear box mode, but left and right (up and down) operation is symmetrical about the neutral position.

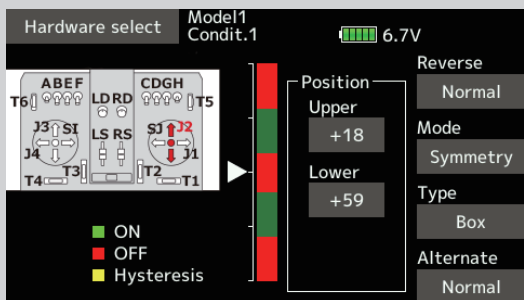

### When shifting the ON/OFF point

The ON/OFF and hysteresis (dead band) boundary point (there are 2 points: top and bottom) position can be shifted. ON/OFF is possible at a free position.

- ◆ Area Green : ON
- ◆ Area Red : OFF
- ◆ Area Yellow : Hysteresis (Dead band)

#### [ Setting method ]

1. Move the stick, etc. to the point you want to shift and touch the [ON/OFF] button. The boundary points change.

Current stick position

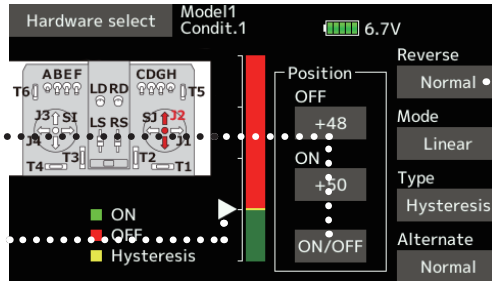

Reverse of ON/OFF direction

#### [ Setting method ] → Box Type

1. Move the stick to the point you want to shift upper side.
2. Touch the [Upper] button. The boundary points change.
3. Move the stick to the point you want to shift lower side.
4. Touch the [Lower] button. The boundary points change.

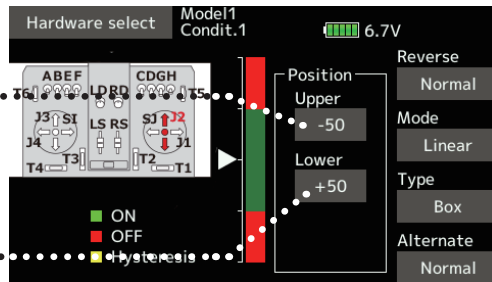

#### ● Symmetry

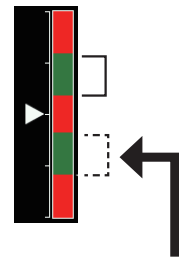

When Upper (Lower) is set, at the same time, Lower (Upper) is also set.

### Hysteresis : Hysteresis (dead band) can be set to ON and OFF

#### [Setting method] → Linear Type

1. Move the stick to the off point you want to shift and touch the [OFF] button. The off points change.
2. Move the stick to the on point you want to shift and touch the [ON] button. The on points change.

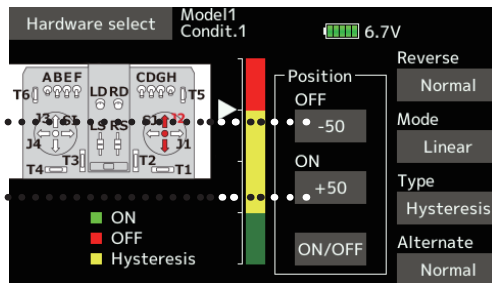

#### ● Symmetry

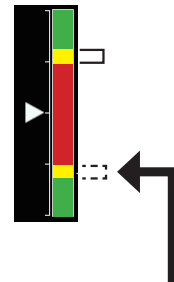

When Upper (Lower) is set, at the same time, Lower (Upper) is also set.

---

## Logic switch (Condition select and DG1, DG2)

---

The logic switch function lets you turn operation on and off by combining two switches. For instance, the condition is activated when 2 switches are turned on.

### Logic mode

AND: When both switches are ON, the condition is ON.

OR: When either switch is ON, the condition is ON.

EX-OR: When the two switches are in different states, the condition is ON.

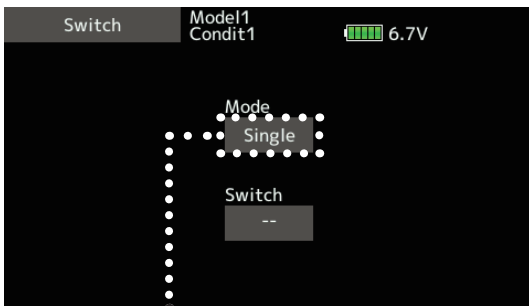

### Switch mode selection

1. Tap to the [Mode] "Single" item.  
(Logic switch setting screen)

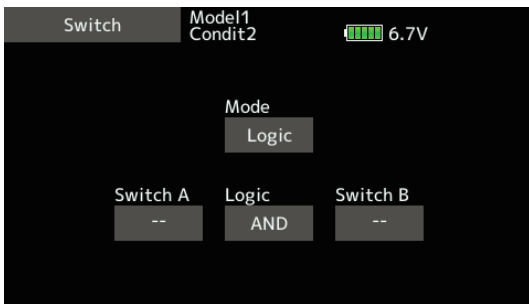

### Switch selection

1. Select the switch A and B.

### Logic mode selection

1. Tap to the [Logic] item.
2. Select the logic mode.



## Updating

Your Futaba FX-36 transmitter programming can be updated easily online. When functions are added or improved, the update file can be downloaded from our website. Copy the update files to the SD card and then use the following procedure to update the program.

Check our web site for the FAQ regarding updating for more information.

### Updating procedure

**Note:** If the battery fully discharges during program updating, updating will fail. When the remaining battery capacity is 50% or less, always recharge the battery before updating.

**Note:** The model data in the transmitter can be used unchanged after updating, but to be safe, back up the model data before updating.

1. Download the zip file of the update data from our website.

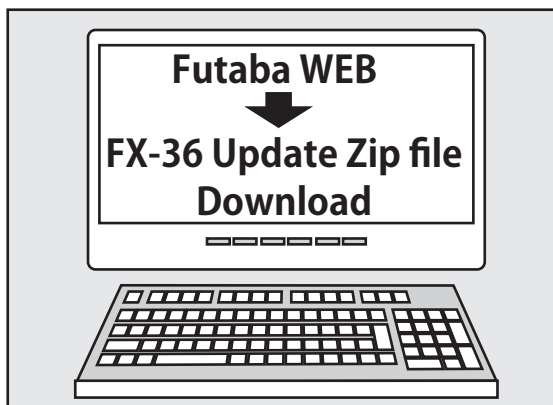

2. Extract the zip file on your computer.
3. The "FUTABA" folder will be created on your computer.
4. Copy the "FUTABA" folder into your SD card.

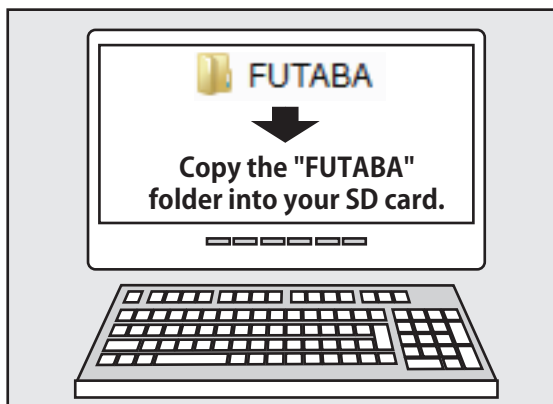

**Note:** If the SD card has already had "another FUTABA" folder before you make a copy, the "FUTABA" folder is OVERWRITTEN.

5. Insert the SD card with "FUTABA" folder that contained the update software into the SD card slot on your FX-36 radio transmitter.

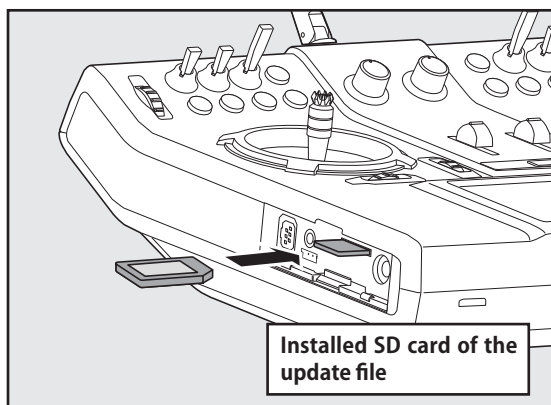

6. Turn on the transmitter power while pressing down the "H/E" button. The update screen appears on the LCD display of your FX-36 and the software update is started.

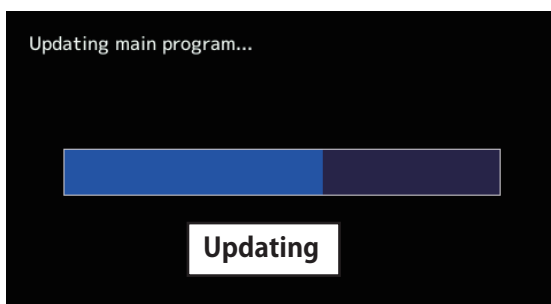
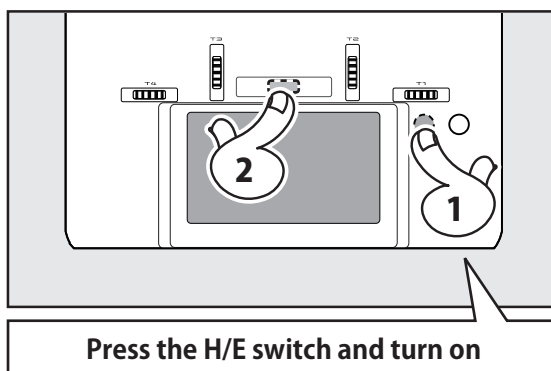

7. When the software update is completed, "Completed" message is shown on the LCD display of your FX-36. (Show below picture.)

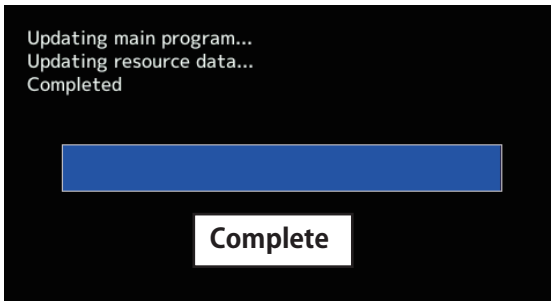

8. Turn off the power switch of your FX-36 and remove the SD card from the card slot.

### **Possible Problems**

When one of the error messages shown below appears on the LCD screen your FX-36, the software update will not be completed.

#### **"Low battery."**

Software update is postponed because of low battery. Retry the software update after the battery is recharged.

#### **"Update file not found."**

The FX-36 cannot find the update file on the SD card. Check to be sure all the update files have been copied onto the SD card.

#### **"Broken file."**

The FX-36 detects the update file error. The update file may be broken or for another transmitter.

#### **"Write error."**

The software update procedure is stopped for an unknown reason. Contact your local service center when this error message appears on the LCD screen of your FX-36.



**Don't absolutely remove the battery and the SD card from the transmitter during the update.**

There is a possibility that the transmitter will be damaged.

Recovering a failed update

If you failed to update for any reason, it may transmitter will not start.

In that case, please update again transmitter in the following procedure.

1. Detach the battery from the transmitter.
2. Insert the SD card that contained the update files to the transmitter.
3. Attach the battery to the transmitter while pressing down the "H/E" button.
4. The update will start.

Even after the above steps, if the transmitter fails to update or does not start, please have it serviced.

### **Initialization of final means**

**Note:** In the unlikely event that model data is damaged and can not be set, the current model data can be initialized by the following method.

**Note:** Do not use it except when data is corrupted.

1. Turn off the power of the transmitter.
2. Hold the H/E button and the U/M Button at the same time, turn on the transmitter power.
3. An initialization warning screen appears.
4. Touch Yes to initialize and turn off the power. Since the current model data is initialized, please reconfigure from the beginning and check the operation sufficiently.

## FX-22/FX-30/T14SG/T12FG →FX-36 MODEL DATA CONVERSION

The model data (only latest version) of FX-22/FX-30/T14SG/T12FG can be copied to FX-36.

- \* SD card is required.
- \* The model data of FX-36 cannot be copied to FX-22/FX-30/T14SG/T12FG.
- \* Functions in FX-22/FX-30/T14SG/T12FG, functions not in FX-36 are not converted.

[Model data conversion method]

1. Attach an SD card that contains model data of FX-22/FX-30/T14SG/T12FG to the SD slot of a FX-36.
2. Turn on the power switch, and the Data Converter should run.

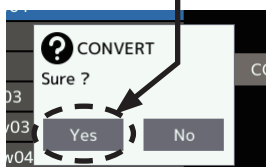
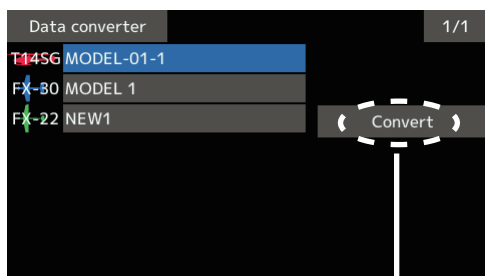

3. The converter shows a list of model data in the card. Select a model data that you want to convert and push "CONVERT" → "Yes" key, and the converter should begin converting data.
4. If the convert succeeds, the converter will show the following message. The converted data are copied to the internal memory of the FX-36. Hence, if the FX-36 does not have available space in its internal memory, converts must fail.

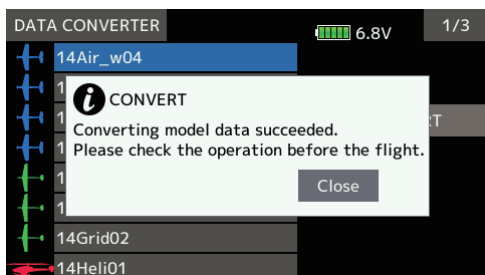

5. The converter can accept model data made by FX-22/FX-30/T14SG/T12FG with the latest software only. If you try to convert model data made by old version software, the converter must fail to convert and show the following error message. If this message is shown, do the following procedure to update the model data in order to avoid this limitation.

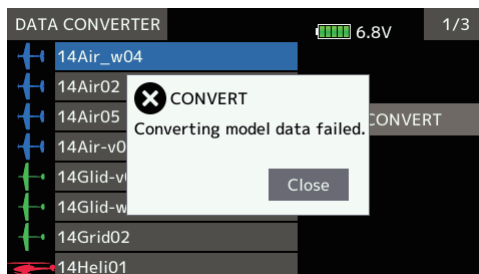

- (a) First, update a FX-22/FX-30/T14SG/T12FG to the latest software.
- (b) Load the model data which failed to convert into the FX-22/FX-30/T14SG/T12FG with the latest software, and the model data should be updated to the latest format.
- (c) Save the updated model data to a SD card.
- (d) Retry to convert the updated model data on a FX-36.

\* When SD card cannot be recognized, it may be able to be used if it reformat by SD formatter offered from SD Association.  
SD formatter is downloadable from SD Association  
<https://www.sdcard.org/> (As of June, 2017)

### ⚠ CAUTION

- ❗ After finishing data copy, be sure to perform a complete check of operation with the model to be used.
- ❗ Check well all the directions of operation and all the operation switches.

**Important: Always check the operation of the model prior to flight.**

FUTABA CORPORATION

Makuhari Techno-Garden Bldg. B-6F, 1-3 Nakase, Mihama-ku, Chiba, 261-8555, Japan  
Phone: +81-43-296-8259, Facsimile: +81-43-296-8253

©FUTABA CORPORATION 2017, 10 (1)