

Airnox™

R/C Flying Made Easy

SPITFIRE



ULTRA MICRO SIZE READY-TO-FLY AIRPLANE

MANUAL



Specifications:

- Span width: 425 mm
- Length: 393 mm
- RTR weight: 54 g
- Radio: MT-180 4-channel 2.4GHz FHSS
- Gyro: Stabilizing 3AXG™ Gyro System
- Battery: 1S/3.7V 200 mAh 20C LiPo
- Charger: Built into the transmitter
- Flight Time: Aprox. 5-7.5 minutes
- Not included: 4x AA alkaline batteries for the transmitter

Version 1.0
2016-03-14

Distributed by:

Minicars Hobby Distribution AB
Annelundsgatan 17C • 749 40 Enköping • Sweden

minicars.se



RoHS



WARNINGS

GENERAL WARNINGS

- Never fly your aircraft from the street or at night. Always fly in an open area free from obstructions.
- When flying, make sure any spectators are behind you.
- Always be conscious of the spinning propeller. Be careful not to allow loose clothing etc to be drawn into the propeller.
- Because your aircraft is operated by radio control, it is important to make sure you are always using fresh and/or fully charged batteries. Never allow the batteries to run low, or you could lose control of the aircraft.
- Never attempt to disassemble any of the aircraft's components - especially the electronics.
- Do not allow any of the electrical components to get wet, or electrical damage may occur.
- You should complete a successful radio range check of your radio equipment prior to each new day of flying, or prior to the first flight of a newly repaired aircraft.
- If your aircraft gets dirty, do not use any solvents to clean it. Solvents will damage the foam and plastic. Use a dry cloth to clean any dirt from outside of the aircraft.
- This product includes small and sharp edged parts. Always assemble and keep this product out of children's reach.
- Recommended minimum user age: 14+.
- Do not fly your airplane on days with strong winds.
- When not using the model, always switch off the receiver by disconnecting the battery and switch off the transmitter. Also remove the LiPo battery from the model and remove the AA batteries from the transmitter as otherwise they may leak and cause damage.
- Do not store the model in a high temperature and/or high humidity area or in direct sunlight.

RADIO CONTROL SYSTEM WARNINGS

- Always turn on the transmitter before turning on the aircraft and always turn off the aircraft before turning off the transmitter.
- Always unplug the battery when not flying the aircraft.
- Never cut the receiver antenna shorter, or you may lose control of the aircraft during flight.
- Never attempt to disassemble or modify any of the radio control system components.

LITHIUM POLYMER (LIPO) WARNINGS - YOU MUST READ THIS BEFORE CHARGING THE BATTERY

- All instructions, warnings and cautions must be followed at all times. Failure to do so can lead to serious injury or fire. Do not use this product before reading and understanding of all directions and warnings.
- Serious injury, loss of property and fire can result from misuse of this product.
- Do not use or charge the battery if the battery is hot.
- Do not leave the model in direct sunlight or in a hot storage area such as a hot car. Do not let any parts get wet or exposed to moisture.
- Do not overcharge the LiPo battery. Maximum voltage (max 4.2V) for each LiPo battery must be followed.
- Do not short-circuit the LiPo battery. Check polarity - then connect the LiPo battery to the charger socket.
- Only discharge and charge the battery outdoors or in a fire safe container.
- Do not operate or charge the LiPo battery unattended.
- Do not use the battery if you do not understand the warnings and proper use of the LiPo battery.
- Always let the battery cool and rest between use and charging. Do not charge inside your car or inside your house.
- We recommend the use of a safe container when charging and storing (such as a LiPo-Safe bag).
- Inspect the battery before each use for swelling or other malfunction. If the LiPo battery has "balooned" it must be discarded (drop it off at your local battery recycling station).
- Do not over discharge or exceed the maximum discharge level (minimum battery voltage = 3.0V)
- Do not poke, bend or damage the battery. The outer casing is soft and can be damaged.
- The LiPo battery must never exceed 71°C for any reason.

This radio control model is not a toy, serious injury to persons or damage to property can result if not used in a responsible manner. Read all instructions carefully prior to assembling and before flying this model. Seek advice should any information be unclear. You assume all risk and responsibility when using this model.

DECLARATION OF CONFORMITY



For the following equipment

Product : Radio Control
Model Number : MT-180
Applicant : Shanghai Merit Technology Corp.
No.1058, Taogan Road, Songjiang District , Shanghai, China
Manufacturer's Name : Merit Technology Corp.
Manufacturer's Address : No.1058, Taogan Road, Songjiang District , Shanghai, China

Supplementary Information:

The product herewith complies with the requirements Directive 1999/5/EC.

Conforms to the following specification:

ETSI EN 300 328 V1.8.1:2012-06
ETSI EN 301 489-1 V1.9.2:2011-09
ETSI EN 301 489-17 V2.2.1:2012-09
EN 60950-1:2006 + A11:2009 +A1:2010 +A12:2011 + A2:2013
EN 62479:2010

The following is responsible for this declaration

Company Name : Merit Technology Corp.

Company Address : No.1058, Taogan Road, Songjiang District , Shanghai, China

Person responsible for marking this declaration

Name : David Cheng Telephone No. : +86-21-57793858

Signature :  Date : 2016/03/10

Items Included

Fuselage

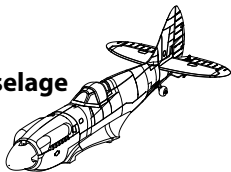

Main Wing

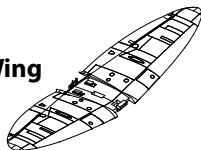

Propeller

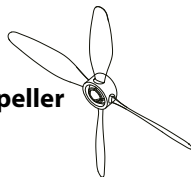

3.7V 200 mAh LiPo Battery

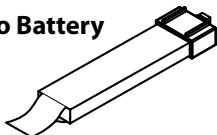

MT-180 2.4GHz
Radio System

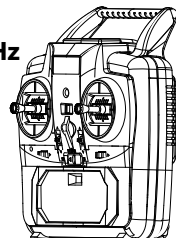

Items Required

4x AA Alkaline Batteries

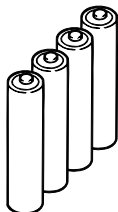

Parts Description

- ❶ Tail Fin
- ❷ Rudder
- ❸ Stabilizer
- ❹ Elevator
- ❺ Elevator Rod
- ❻ Rudder Rod
- ❼ Main Wing
- ❽ Control Horn
- ❾ Control Horn
- ❿ Propeller
- ⓫ Aileron

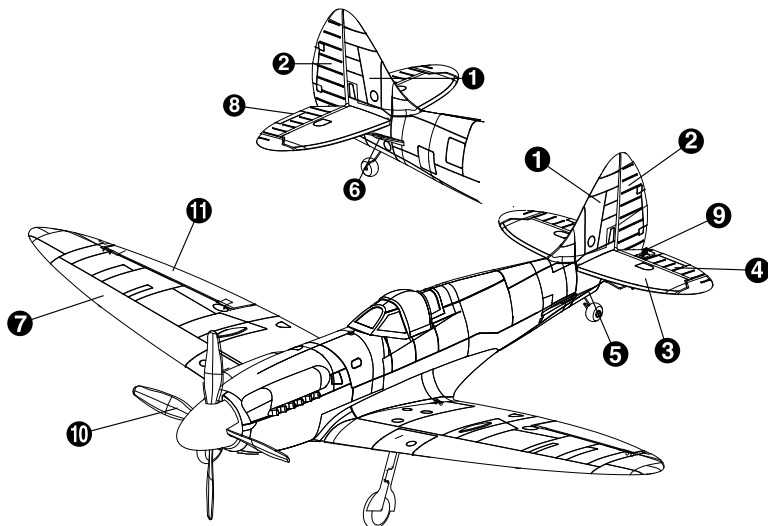

Transmitter

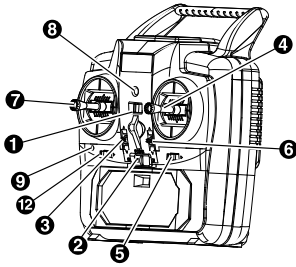

Mode 1

- 1 Mode Change Switch**
- 2 Power Switch**
- 3 Elevator Trim (Up/Down)**
Adjust it so the airplane flies level and straight horizontal wise
- 4 Throttle Stick (Up/Down)**
Controls the motor rpm/propeller speed
Aileron Stick (Left/Right)
Controls the airplane's left/right roll movement
- 5 Aileron Trim (Left/Right)**
Adjust it so the airplane flies straight roll wise
- 6 Throttle Trim (Up/Down)**
Adjust it so the motor will not rotate at the throttle stick down position
- 7 Elevator Stick (Up/Down)**
Controls the airplane's up/down movements
Rudder Stick (Left/Right)
Controls the left/right direction of the airplane's nose
- 8 Battery Level Indicator**
- 9 Charge Indicator Lamp**
- 10 Battery Cover**
- 11 Charge Terminal Cover**
- 12 Rudder Trim (Left/Right)**
Adjust it left/right so the airplane flies straight

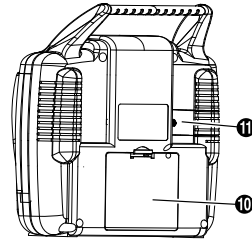

Mode 2

- 1 Mode Change Switch**
- 2 Power Switch**
- 3 Throttle Trim (Up/Down)**
Adjust it so the motor will not rotate at the throttle stick down position
- 4 Elevator Stick (Up/Down)**
Controls the the airplane's up/down movements
Aileron Stick (Left/Right)
Controls the airplane's left/right roll movement
- 5 Aileron Trim (Left/Right)**
Adjust it so the airplane flies straight roll wise
- 6 Elevator Trim (Up/Down)**
Adjust it so the airplane flies level and straight horizontal wise
- 7 Throttle Stick (Up/Down)**
Controls the motor rpm/propeller speed
Rudder Stick (Left/Right)
Controls the left/right direction of the airplane's nose
- 8 Battery Level Indicator**
- 9 Charge Indicator Lamp**
- 10 Battery Cover**
- 11 Charge Terminal Cover**
- 12 Rudder Trim (Left/Right)**
Adjust it left/right so the airplane flies straight

Before Operating

Installing the transmitter batteries

Remove the battery cover

Insert 4x AA batteries. Note the correct polarity!

Close the battery cover

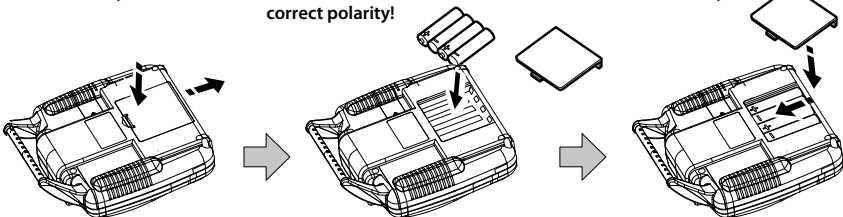

Charging the LiPo battery



- Read page 2 carefully and charge the LiPo battery accordingly.
- Use only the specified charger.
- Do not charge a damaged battery - this may cause fire or serious damage.

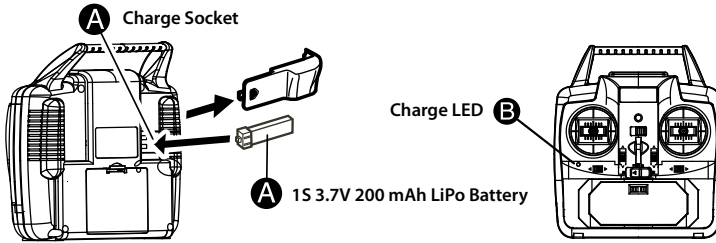

- A** Connect the 3.7V 200 mAh LiPo battery to the charge socket.
- B** The charge LED will light up and quick charging starts. A fully discharged battery takes about 40 minutes to charge.
- B** After the charging LED will go off, the charging is complete.

Mode 1 & Mode 2 Switch

The transmitter can easily be changed from Mode 1 to Mode 2 with the mode change switch. In Europe it's most common to use Mode 2 that uses the throttle on the left stick.

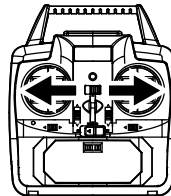

- 1** Move the left and right hand sticks to the neutral position.
- 2** Make sure the mode change switch is moved all the way to its end location.

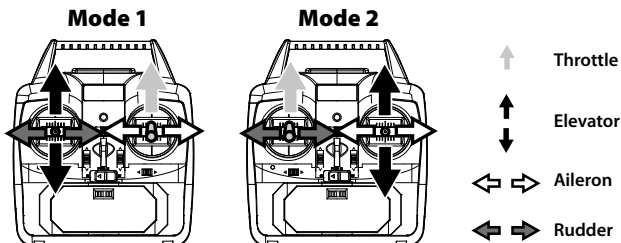
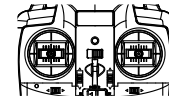

Binding of the Transmitter and the Airplane

The binding procedure is already done at the factory and the model is ready to be used. But if the binding is lost, follow the below procedure to get the model and transmitter to recognize each other (bind).

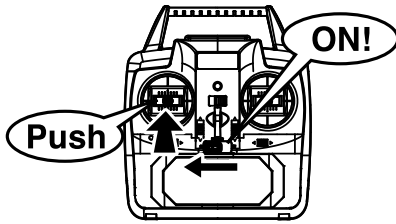

1

While pushing/pressing down the throttle stick, turn the power switch ON. The transmitter will beep for 20 seconds.

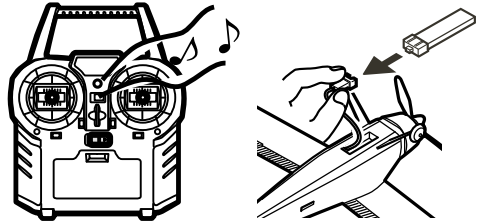

2

Connect the LiPo battery to the airplane while the transmitter is beeping.

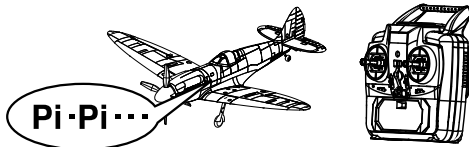

3

When the airplane beeps, turn OFF the transmitter and then ON again. The binding process is done.

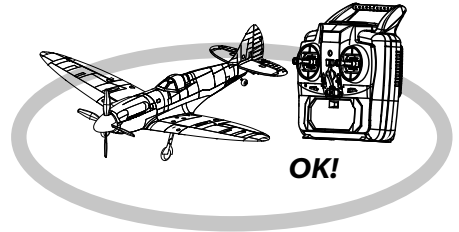

3AXG™ Gyro Calibration Procedure

- Connect the LiPo battery within 20 seconds from turning on the transmitter.
- Leave the model stable on a flat surface for another 3-5 seconds for the calibration of the 3AXG™ gyro system.
- Make sure all the trim's are within neutral +/- 7 steps (except the throttle trim) for the calibration to start.
- The gyro calibration must be done every time the transmitter and model is turned on, otherwise it will not function correctly.

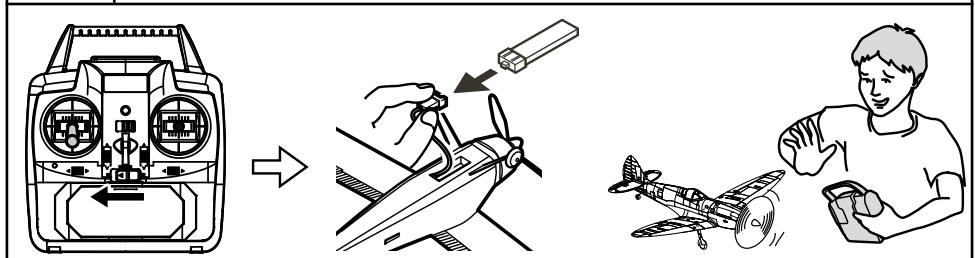
	<ul style="list-style-type: none">• Always turn on the transmitter first.• Ensure the throttle stick is all the way down - a spinning propeller can be dangerous.
	

Choosing Your Airfield

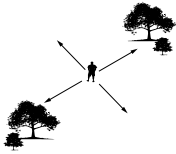

- 1 Choose a flying field that is a large open field with grass. There should be no vehicles, no buildings, no powerlines, no trees, no large rocks or anything else that your model can crash into.

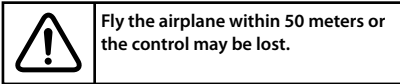

Fly the airplane within 50 meters or the control may be lost.

- 2 Size of an indoor hall - see drawing to the right.

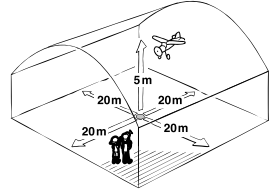

Choosing a Day to Fly

Calm weather with either no wind at all or a wind speed of 1-2 m/s is suitable for flying.

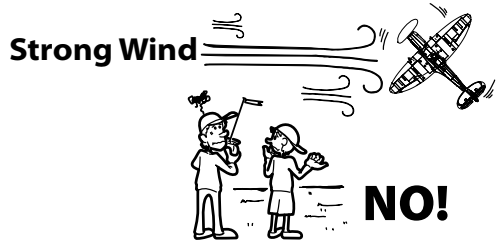
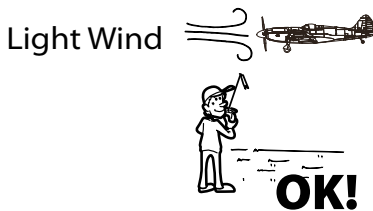

Pre-Flight Check

- 1 Check for any broken or damaged parts on the wing, fuselage or tail wing.

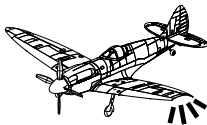

- 2 Be sure the propeller and spinner are properly attached.

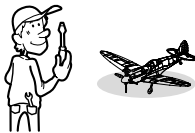

- 3 Switch ON the transmitter and connect the battery. Follow the binding and calibration procedures explained earlier.

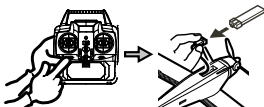

- 4 If the motor starts rotating accidentally, have an assistant hold the rear of the airplane securely.

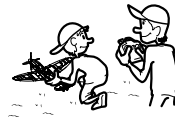

- 5 Check that the airplane respond properly to control signals.

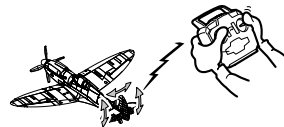

- 6 Test the range of the radio signal. Step back about 10 m and check for any unusual behavior.

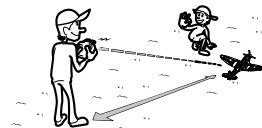

Take Off

Check that the airplane responds correctly to control signals.

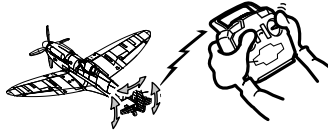

Apply full throttle while facing into the wind. Hold the plane horizontally and launch it forward with a steady hand motion.

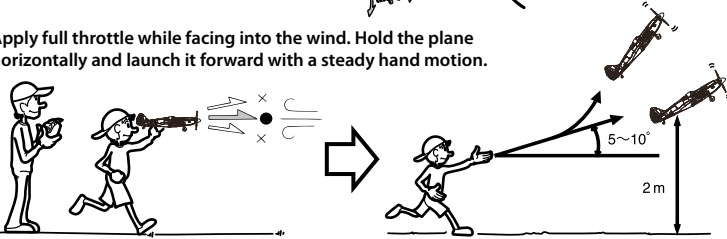

After launching the airplane, use the rudder to adjust the motion where the airplane is traveling left/right. If the airplane rolls sideways left or right - adjust the motion with the ailerons. If the airplane does not climb - adjust it with the elevator stick. After reaching about 2 meter altitude, begin circling the airplane. (If the battery isn't charged fully the airplane will not ascend.)

Adjusting the Neutral Trims

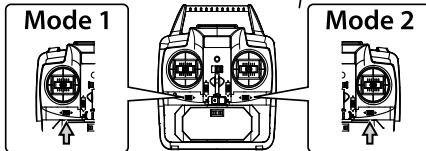
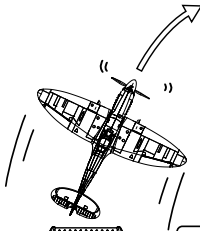

Fly the airplane level/horizontal.

Release your finger from the rudder stick.

If the nose of the airplane flies to the right/left - adjust the neutral trims until the model flies straight.

Do the same with the aileron stick. If the plane rolls in any direction - adjust the aileron neutral trim until it flies straight.

Each trim position is indicated with a beeping sound.

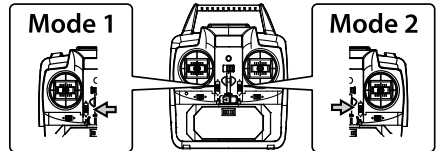
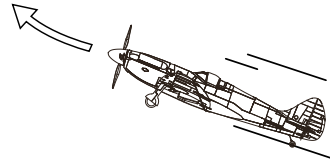
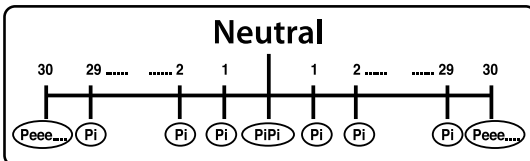

Fly the airplane level/horizontal.

Release your finger from the elevator stick.

If the airplane dives or climbs - adjust the elevator neutral trim until it flies straight.

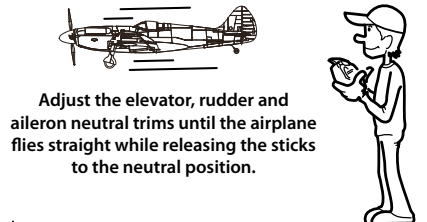

Adjust the elevator, rudder and aileron neutral trims until the airplane flies straight while releasing the sticks to the neutral position.

Landing

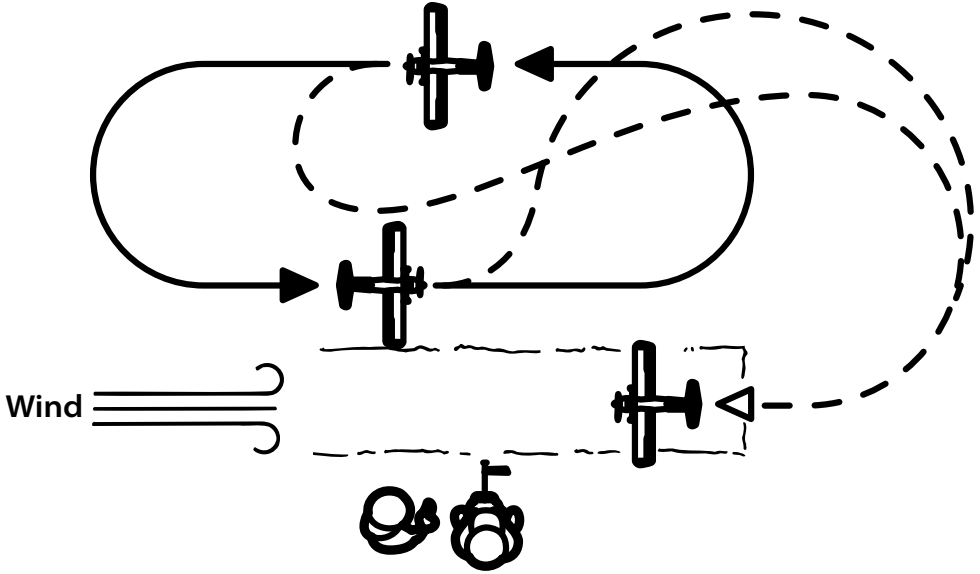

- ▶ When the LiPo battery power runs low the auto-cut function will stop the propeller. So aim for about 5-6 minutes of flight time and then land the airplane before the auto-cut function stops the motor from running.
- ▶ When landing, make a wide turn with the wind and then land the airplane into the wind.

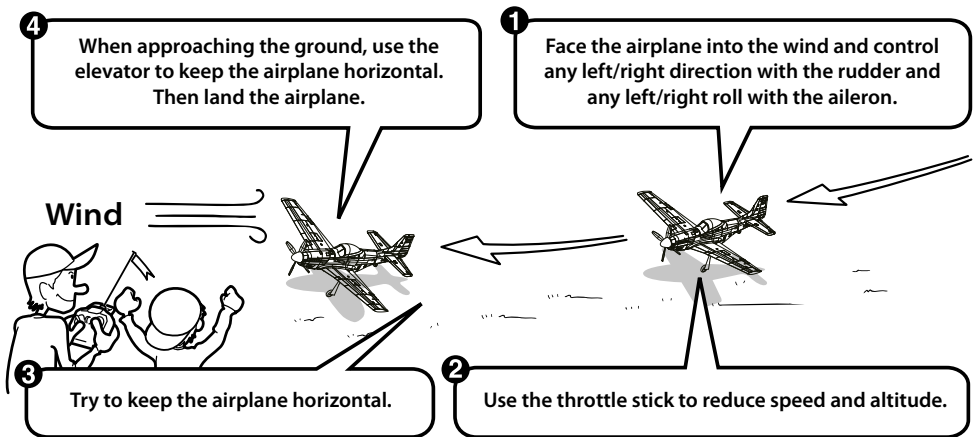

After Landing

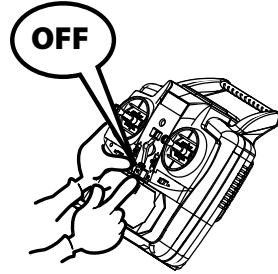
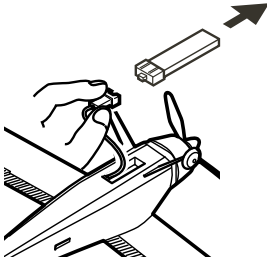

1 Disconnect the LiPo battery and recharge it.

2 Switch OFF the transmitter.



- The LiPo battery can become hot/warm after flight. Always let the battery cool down before recharging.
- Recharge the battery before storage.
- Don't store a discharged LiPo battery - it may become destroyed and/or cause damage.

After Flight Maintenance

1 Always remove the LiPo battery from the airplane after use and store the battery separately in a safe place and/or in a LiPo-Safe bag. Remove the AA batteries from the transmitter.

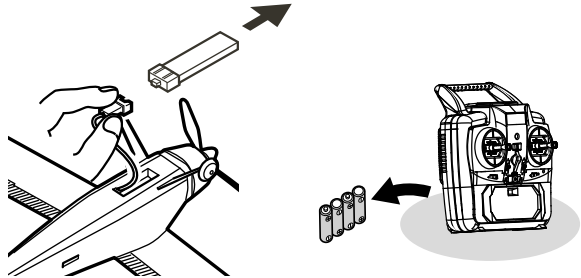

2 Check that no screws have loosened and replace any damaged parts before the next flight.

Use a foam-safe glue when repairing the model.

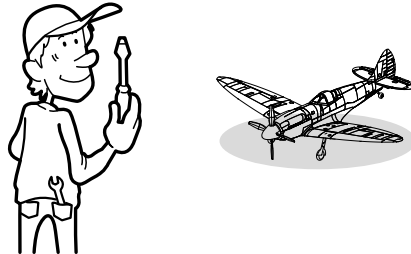

3 Clean and remove any dirt from the model.

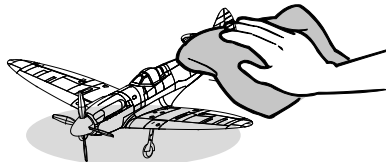

WARRANTY

All products sold by Minicars Hobby Distribution AB are covered by a 1 year warranty. The warranty covers manufacturing defects, with the exception of:

- Neglect or improper handling of the product
- Wear and tear parts such as wings, fuselage, propellers and bearings etc
- Consumables such as batteries
- Congestion damages
- Water damages
- Modified products

SPARE PARTS

#AN10100 - 1S 3.7V 200 mAh LiPo Battery

#AN10301 - Propeller & Spinner set for P-51D Mustang

