

T6L

Sport

6-Channel Digital Proportional R/C System



INSTRUCTION MANUAL

Futaba[®]

1M23N32701

Digital Proportional R/C System



TABLE OF CONTENTS

● Introduction	3
● Support and Service	3
● Application, Export, and Modification	4
● Definitions of Symbols	6
● Precautions (do not operate without reading)	6

● Features	9
● Contents	9
● System compatibility	9
● Transmitter controls	10
● Receiver R3106GF	11
● Installation of the Battery	12
● Transmitter power ON/OFF (and fail-safe)	13
● Monitor LED	13
● Stick control	13
● Stick control : Airplane Example	14
● Trim	15
● Channel-5 · Switch	16
● Channel-6 · Dial	16
● Trainer function (Student only)	16
● Link procedure	17
● Power down mode	18
● Servo reverse	19
● Elevon mixing	20
● V-Tail mixing	20
● Flaperon mixing	21
● When a mixing isn't used (Normal)	21
● Mounting the receiver switch	22
● Safety precautions when you install receiver and servos	22
● Change to mode1	23
● Technical specifications	24

Technical updates and additional programming examples available at: <http://www.futaba-rc.com/faq>

Entire Contents © 2017

INTRODUCTION

Thank you for purchasing a Futaba® T-FHSS Air-2.4GHz 6L Sport series digital proportional R/C system. In order for you to make the best use of your system and to fly safely, please read this manual carefully. If you have any difficulties while using your system, please consult the manual, our online Frequently Asked Questions (on the web pages referenced below), your hobby dealer, or the Futaba Service Center.

Due to unforeseen changes in production procedures, the information contained in this manual is subject to change without notice.

Support and Service: It is recommended to have your Futaba equipment serviced annually during your hobby's "off season" to ensure safe operation.

IN NORTH AMERICA

Please feel free to contact the Futaba Service Center for assistance in operation, use and programming. Please be sure to regularly visit the 6L Sport Frequently Asked Questions web site at www.futaba-rc.com/faq/. This page includes extensive programming, use, set up and safety information on the 6L Sport radio system and is updated regularly. Any technical updates and US manual corrections will be available on this web page. If you do not find the answers to your questions there, please see the end of our F.A.Q. area for information on contacting us via email for the most rapid and convenient response.

Don't have Internet access? Internet access is available at no charge at most public libraries, schools, and other public resources. We find internet support to be a fabulous reference for many modelers as items can be printed and saved for future reference, and can be accessed at any hour of the day, night, weekend or holiday. If you do not wish to access the internet for information, however, don't worry. Our support teams are available Monday through Friday 8-5 Central time to assist you.

FOR SERVICE ONLY:

Futaba Service Center
3002 N. Apollo Drive, Suite 1
Champaign, IL 61822
Phone: 217-398-0007
www.futaba-rc.com/service.html
Email: futabaservice@hobbico.com

FOR SUPPORT : (PROGRAMMING AND USER QUESTIONS)

Please start here for answers to most questions:
www.futaba-rc.com/faq/
Fax: 217-398-7721
Phone: 217-398-8970 option 2

OUTSIDE NORTH AMERICA

Please contact your Futaba importer in your region of the world to assist you with any questions, problems or service needs.

Please recognize that all information in this manual, and all support availability, is based upon the systems sold in North America only. Products purchased elsewhere may vary. Always contact your region's support center for assistance.

Application, Export, and Modification

1. This product may be used for unmanned aerial vehicle use. It is not intended for use in any application other than unmanned aerial vehicle control. The product is subject to regulations of the Ministry of Radio/Telecommunications and is restricted under Japanese law to such purposes.

2. Exportation precautions:

(a) When this product is exported from the country of manufacture, its use is to be approved by the laws governing the country of destination which govern devices that emit radio frequencies. If this product is then re-exported to other countries, it may be subject to restrictions on such export. Prior approval of the appropriate government authorities may be required. If you have purchased this product from an exporter outside your country, and not the authorized Futaba distributor in your country, please contact the seller immediately to determine if such export regulations have been met.

(b) Use of this product with anything other than models may be restricted by Export and Trade Control Regulations, and an application for export approval must be submitted. This equipment must not be utilized to operate equipment other than radio controlled models.

3. Modification, adjustment, and replacement of parts: Futaba is not responsible for unauthorized modification, adjustment, and replacement of parts on this product. Any such changes may void the warranty.

Compliance Information Statement

This device complies with part 15 of the FCC Rules. Operation is subject to the following three conditions:

(1) This device may not cause harmful interference, and (2) This device must accept any interference received, including interference that may cause undesired operation.

(3) RF Radiation Exposure Statement

This equipment complies with FCC radiation exposure limits set forth for an uncontrolled environment.

This transmitter must not be co-located or operating in conjunction with any other antenna or transmitter.

The responsible party for the compliance of this device is:

Futaba Service Center

3002 N Apollo Drive Suite 1, Champaign, IL 61822 U.S.A.

TEL (217)398-8970 or E-mail: support@hobbico.com (Support)

TEL (217)398-0007 or E-mail: futabaservice@hobbico.com (Service)



The RBRC. SEAL on the nickel-cadmium battery contained in Futaba products indicates that Futaba Corporation is voluntarily participating in an industry-wide program to collect and recycle these batteries at the end of their useful lives, when taken out of service within the United States. The RBRC. program provides a convenient alternative to placing used nickel-cadmium batteries into the trash or municipal waste system, which is illegal in some areas.

(for USA)

You may contact your local recycling center for information on where to return the spent battery. Please call 1-800-8BATTERY for information on NiCd battery recycling in your area. Futaba Corporation involvement in this program is part of its commitment to protecting our environment and conserving natural resources.

*RBRC is a trademark of the Rechargeable Battery Recycling Corporation.

NOTE:

This device complies with Industry Canada license-exempt RSS standard(s). Operation is subject to the following two conditions: (1) this device may not cause interference, and (2) this device must accept any interference, including interference that may cause undesired operation of the device.

This equipment complies with IC radiation exposure limits set forth for an uncontrolled environment. This equipment should be installed and operated with minimum distance 20cm between the radiator and your body.

French: Cet appareil radio est conforme au CNR-210 d'Industrie Canada. L'utilisation de ce dispositif est autorisée seulement aux deux conditions suivantes : (1) il ne doit pas produire de brouillage, et (2) l'utilisateur du dispositif doit être prêt à accepter tout brouillage radioélectrique reçu, même si ce brouillage est susceptible de compromettre le fonctionnement du dispositif. Cet équipement est conforme aux limites d'exposition aux rayonnements IC établies pour un environnement non contrôlé. Cet équipement doit être installé et utilisé avec un minimum de 20 cm de distance entre la source de rayonnement et votre corps.

This radio transmitter has been approved by Industry Canada to operate with the antenna types listed below with the maximum permissible gain indicated. Antenna types not included in this list, having a gain greater than the maximum gain indicated for that type, are strictly prohibited for use with this device.

No.	Name	Gain(Peak)	Remark
1	Internal pattern	2.14dBi	1/2 λ pattern type antenna

CAUTION:

To assure continued FCC compliance:

Any changes or modifications not expressly approved by the grantee of this device could void the user's authority to operate the equipment.

Where to Fly

We recommend that you fly at a recognized model airplane flying field. You can find model clubs and fields by asking your nearest hobby dealer, or, in the US, by contacting the Academy of Model Aeronautics.

The national Academy of Model Aeronautics (AMA) has more than 2,500 chartered clubs across the country. Through any one of them, instructor training programs and insured newcomer training are available. Contact the AMA at the address or toll-free phone number below.

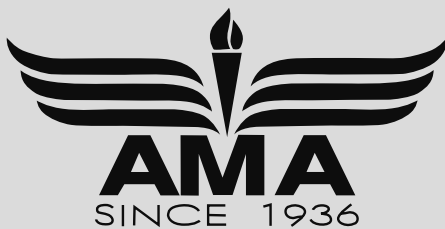

Academy of Model Aeronautics

5161 East Memorial Drive

Muncie, IN 47302

Tele. (800) 435-9262

Fax (765) 289-4248

or via the Internet at <http://www.modelaircraft.org>

Always pay particular attention to the flying field's rules, as well as the presence and location of spectators, the wind direction, and any obstacles on the field. Be very careful flying in areas near power lines, tall buildings, or communication facilities as there may be radio interference in their vicinity.

Precautions

Application, Export, and Modification Precautions.

1. This product is only designed for use with radio control models. Use of the product described in this instruction manual is limited to radio control models.
2. Export precautions:
 - a) When this product is exported, it cannot be used where prohibited by the laws governing radio waves of the destination country.
 - b) Use of this product with other than models may be restricted by Export and Trade Control Regulations.
3. Modification, adjustment, and parts replacement

Futaba is not responsible for unauthorized modification, adjustment, or replacement of parts on this product.

 - No part of this manual may be reproduced in any form without prior permission.
 - The contents of this manual are subject to change without prior notice.
 - The contents of this manual should be complete, but if there are any unclear or missing parts please contact a Futaba Service Center.
 - Futaba is not responsible for the use of this product by the customer.
 - Company and product names in this manual are trademarks or registered trademarks of the respective company.

For safe use

Please observe the following precautions to ensure safe use of this product at all times.

Meaning of Special Markings:

The parts of this manual indicated by the following marks require special attention from the standpoint of safety.

- ⚠ **DANGER** - Procedures which may lead to dangerous conditions and cause death/serious injury if not carried out properly.
- ⚠ **WARNING** - Procedures which may lead to a dangerous condition or cause death or serious injury to the user if not carried out properly, or procedures where the probability of superficial injury or physical damage is high.
- ⚠ **CAUTION** - Procedures where the possibility of serious injury to the user is small, but there is a danger of injury, or physical damage, if not carried out properly.

⊘ = Prohibited ! = Mandatory

WARNING: Always keep electrical components away from small children.

Flying Precautions

⚠ WARNING

⊘ **Never grasp the built-in transmitter antenna while flying.**

■ The transmitter output may drop drastically.

! **Always make sure that all transmitter stick movements operate all servos properly in the model prior to flight. Also, make sure that all switches, etc. function properly as well. If there are any difficulties, do not use the system until all inputs are functioning properly.**

⊘ **Never fly in range check mode.**

■ In the dedicated range test range check mode, the transmitter output range is reduced and may cause a crash.

⊘ **While operating, never touch the transmitter with, or bring the transmitter near, another transmitter, a cellphone, or other wireless devices.**

■ Doing so may cause erroneous operation.

⊘ **Never fly on a rainy day, when the wind is strong or at night.**

■ Water could lead to failure or improper functionality and poor control of the aircraft which could lead to a crash.

⊘ **Never turn the power switch off during flight or while the engine or motor is running.**

■ Operation will become impossible and the aircraft will crash. Even if the power switch is turned on, operation will not begin until transmitter and receiver internal processing is complete.

⊘ **Do not start the engine or motor while wearing the neck strap.**

■ The neck strap may become entangled with the rotating propeller, rotor, etc. and cause serious injury.

⊘ **Do not fly when you are physically impaired as it could pose a safety hazard to yourself or others.**

⊘ **Do not fly at the following places:**

- Near another radio control flying field.
- Near or above people.
- Near homes, schools, hospitals or other places where people congregate.
- Near high voltage lines, high structures, or communication facilities.

⊘ **When setting the transmitter on the ground during flight preparations, do not stand it upright.**

- The transmitter may tip over, the sticks may move and the propeller or rotor may rotate unexpectedly and cause injury.

⊘ **Do not touch the engine, motor, or FET amp during and immediately after use.**

- These items may become hot during use.

ⓘ **For safety, fly so that the aircraft is visible at all times.**

- Flying behind buildings or other large structures will not only cause you to lose sight of the aircraft, but also degrade the RF link performance and cause loss of control.

ⓘ **From the standpoint of safety, always set the fail safe function.**

- In particular, normally set the throttle channel to idle.

ⓘ **Always check the remaining capacity of the transmitter and receiver batteries before each flying session prior to flight.**

- Low battery capacity will cause loss of control and a crash.

ⓘ **Always check operation of each control surface and perform a range test before each flying session. Also, when using the trainer function, check the operation of both the teacher and student transmitter.**

- Even one incorrect transmitter setting or aircraft abnormality can cause a crash.

ⓘ **Before turning on the transmitter:**

1. Always move the transmitter throttle stick position to the minimum (idle) position.

2. Turn on the transmitter first and then the receiver.

ⓘ **When turning off the transmitter's power switch. After the engine or motor has stopped (state in which it will not rotate again):**

1. Turn off the receiver power switch.
2. Then turn off the transmitter power switch.

- If the power switch is turned on/off in the opposite order, the propeller may rotate unexpectedly and cause a serious injury.

- Also always observe the above order when setting the fail safe function.

- Maximum low throttle: Direction in which the engine or motor runs at the slowest speed or stops.

ⓘ **When adjusting the transmitter, stop the engine except when necessary. In the case of a motor, disconnect the wiring and don't allow it to continue operation. When doing so, please exercise extreme caution. Ensure that the aircraft is secured and that it will not come into contact with anything or anyone. Ensure that the motor will not rotate prior to making any adjustments.**

- Unexpected high speed rotation of the engine may cause a serious injury.

Battery and Charger Handling Precautions

⚠ **DANGER**

⊘ **Do not recharge a battery that is damaged, deteriorated, leaking electrolyte, or wet.**

⊘ **Do not use the charger in applications other than as intended.**

⊘ **Do not allow the charger or battery to become wet.**

- Do not use the charger, when it or your hands, are wet. Do not use the charger in humid places.

⊘ **Do not short circuit the battery.**

⊘ **Do not solder, repair, deform, modify, or disassemble the battery and/or battery charger.**

⊘ **Do not drop the battery into a fire or bring it near a fire.**

⊘ **Do not charge and store the battery in direct sunlight or other hot places.**

⊘ **Do not charge the battery if it is covered with any object as it may become very hot.**

⊘ **Do not use the battery in a combustible environment.**

- The combustibles may ignite and cause an explosion or fire.

ⓘ **Always charge the battery before each flying session.**

- If the battery goes dead during flight, the aircraft will crash.

ⓘ **Always use the charger with the specified power supply voltage.**

- Use the special charger by connecting it to a proper power outlet.

ⓘ **If the battery liquid should get in your eyes, do not rub your eyes, but immediately wash them with tap water or other clean water and get treated by a doctor.**

- The liquid can cause blindness.

⚠ WARNING

⊘ Do not touch the charger and battery for any length of time during charging.

■ Doing so may result in burns.

⊘ Do not use a charger or battery that has been damaged.

⊘ If any abnormalities such as smoke or discoloration are noted with either the charger or the battery, remove the battery from the charger and disconnect the power cord plug and do not use the charger.

■ Continued use may cause fire, combustion, generation of heat, or rupture.

⊘ Do not subject the batteries to impact.

■ Doing so may cause fire, combustion, generation of heat, rupture, or liquid leakage.

⚠ CAUTION

⊘ Do not place heavy objects on top of the battery or charger. Also, do not place the battery or charger in any location where it may fall.

■ Doing so may cause damage or injury.

⊘ Do not store or use the battery and charger where it is dusty or humid.

■ Insert the power cord plug into the receptacle only after eliminating the dust.

⚠ If the battery leaks liquid or generates an abnormal odor, immediately move it to a safe place for disposal.

■ Not doing so may cause combustion.

⚠ If the battery liquid gets on your skin or clothing, immediately flush the area with tap water or other clean water.

■ Consult a doctor. The liquid can cause skin damage.

⚠ After the specified charging time has elapsed, end charging and disconnect the charger from the receptacle.

⚠ When recycling or disposing of the battery, isolate the terminals by covering them with cellophane tape.

■ Short circuit of the terminals may cause combustion, generation of heat or rupture.

⊘ Do not charge the battery in extreme temperatures.

■ Doing so will degrade the battery performance. An ambient temperature of 10°C to 30°C (50 °F to 86 °F) is ideal for charging.

⚠ Unplug the charger when not in use.

⊘ Do not bend or pull the cord unreasonably and do not place heavy objects on the cord.

■ The power cord may be damaged and cause combustion, generation of heat, or electric shock.

Storage and Disposal Precautions

⚠ CAUTION

⊘ Do not store wireless devices in the following places:

- Where it is extremely hot (40°C [104F] or higher) or cold (-10°C [14F] or lower)
- Where the equipment will be exposed to direct sunlight
- Where the humidity is high
- Where vibration is prevalent
- Where it is very dusty
- Where the device may be exposed to steam and heat

⚠ When the device will not be used for a long time, remove the battery from the transmitter and aircraft and store them in a dry place where the temperature is between 0 and 30°C [32F and 86F].

■ When left 'as is', batteries may deteriorate, leak, or be otherwise damaged.

Other Precautions

⚠ CAUTION

⊘ Do not directly expose plastic parts to fuel, oil, exhaust gas, etc.

■ If left in such an environment, the plastic may be damaged.

■ Since the metal parts of the case may corrode, always keep them clean.

⚠ Join the Academy of Model Aeronautics.

■ The Academy of Model Aeronautics (AMA) provides guidelines and liability protection should the need arise.

⚠ Always use genuine Futaba products such as transmitter, receiver, servo, FET amplifier, battery, etc.

■ Futaba is not responsible for damage sustained by combination with parts other than Futaba Genuine Parts. Use the parts specified in the instruction manual and catalog.

FEATURES

T6L Sport transmitter

- **T-FHSS Air (Mono directional)-2.4GHz 6-channel transmitter**

The Futaba 2.4GHz T-FHSS Air system is employed. (*No telemetry)

- **Built-in antenna**

Antenna built into the transmitter provides a simple appearance and improves handling ease.

- **Power-saving type transmitter**

Four AA alkaline batteries can be used.

- **Mixing type selection**

Elevon, V-Tail, and Flaperon mixing type can be selected to match the aircraft type.

- **Trainer function (Student only)**

The T6L Sport trainer function lets you practice flying as a student by connecting the T6L Sport to the instructor's Futaba transmitter.

- **AUX Channel 5 switch function**

- **AUX Channel 6 dial function**

R3106GF receiver

- **T-FHSS Air (Mono directional)-2.4GHz 6-channel receiver**

The Futaba 2.4GHz T-FHSS Air system is employed. (*No telemetry)

- **Fail Safe function (Throttle channel <ch3> only)**

The Fail Safe function is recommended to use for safety reasons in the event of radio interference.

The "F/S" (Fail Safe) function moves the throttle servo to a predetermined position.

CONTENTS

- **Transmitter T6L Sport**

- **Receiver R3106GF**

- **Instruction manual**

SYSTEM COMPATIBILITY

The T6L uses Futaba's 2.4GHz T-FHSS Air transmission system. The compatible receivers are shown below.

Communications System	Usable Receivers
T-FHSS Air	R3006SB, R3008SB, R3001SB *R304SB,R304SB-E,R314SB,R314SB-E,T-FHSS surface system receivers do not operate.

NOTE :

*The Futaba **T-FHSS Air** system cannot be used with Futaba **S-FHSS/FASST/FASSTest** systems. Use it with a **T-FHSS Air** system transmitter and receiver. However, the telemetry system cannot be used.

*The **T-FHSS Air system** and **T-FHSS** surface system are different. The **T6L** cannot be used with the **R304SB,R304SB-E,R314SB,R314SB-E** or **T-FHSS** surface system receivers.

TRANSMITTER CONTROLS-T6L Sport (in case of mode 2)

Transmitter T6L Sport

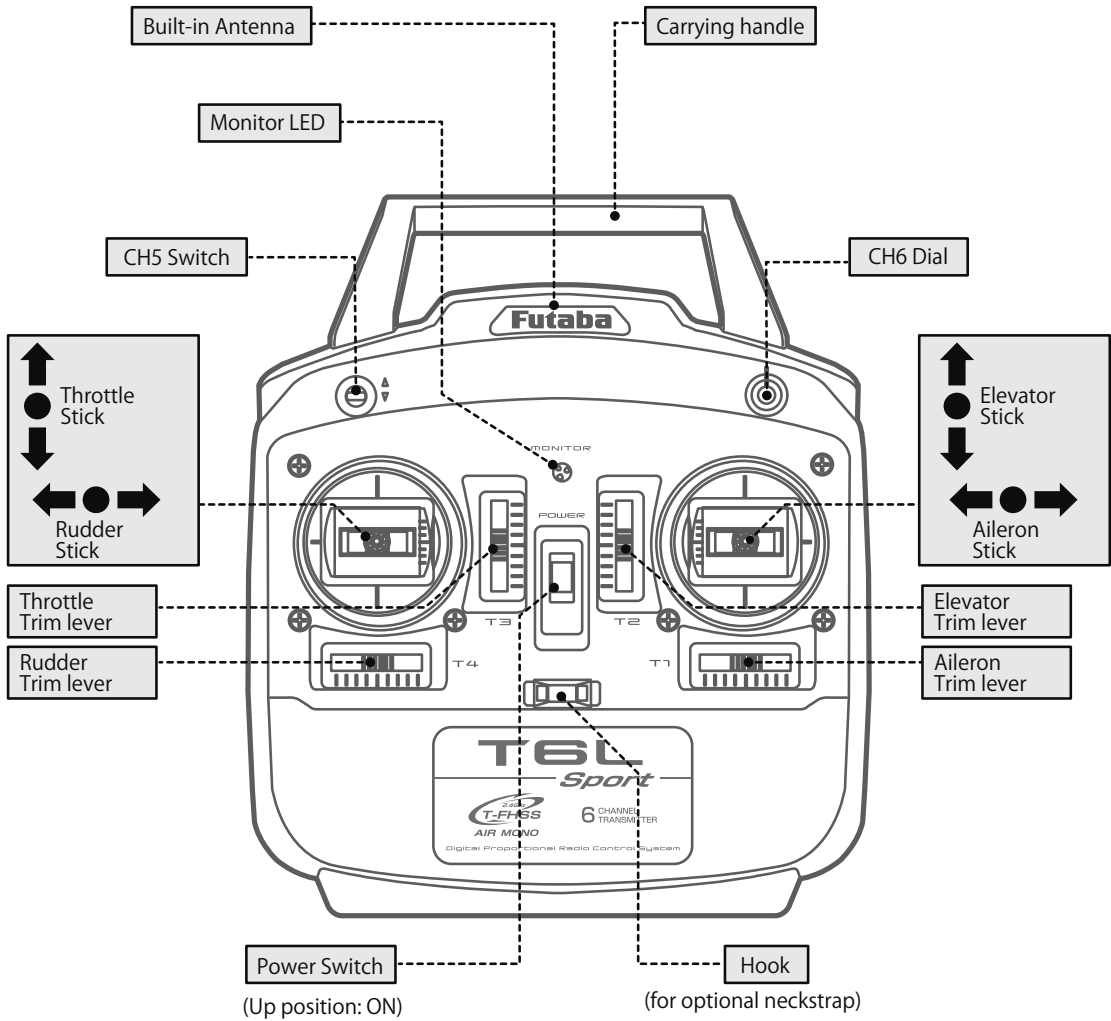

How to hold the transmitter

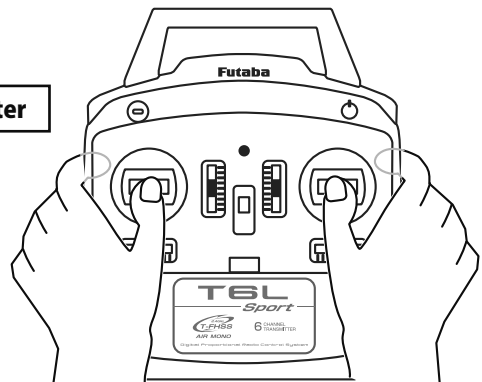

CAUTION

- When operating the dial or the switch, be careful not to drop the transmitter.

Receiver R3106GF

The R3106GF receiver has 6 PWM channel outputs.

R3106GF is T-FHSS Air system, but the telemetry function isn't equipped.

Connection example

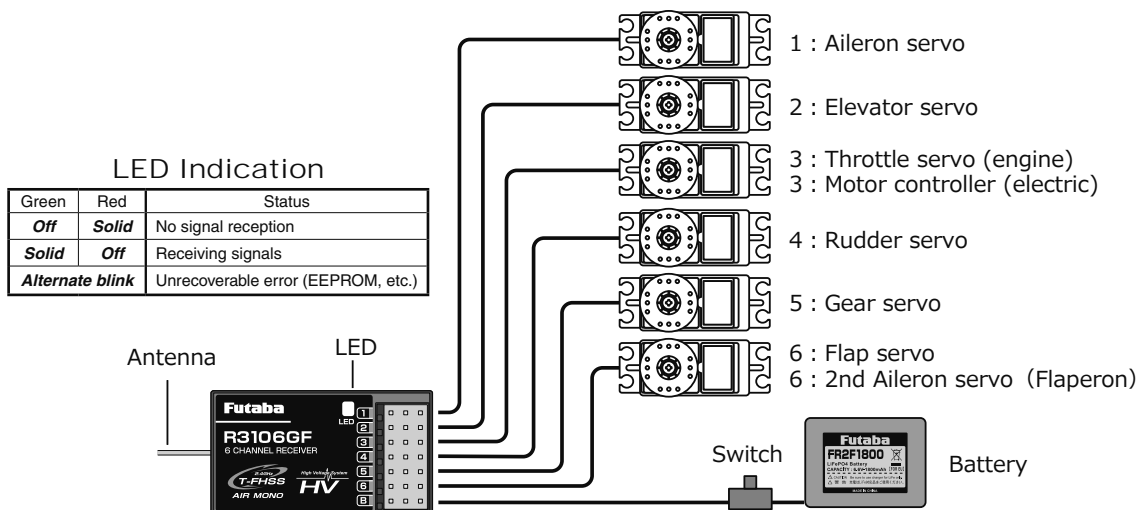

(Note: When power is supplied from a motor controller, a separate power supply is not required.)

Receiver installation precaution

⚠ WARNING

❗ The R3106GF receiver should be protected from vibration by foam rubber, hook and loop tape, or similar mounting methods. Protect from moisture.

❗ Keep away from conductive materials to avoid short circuits.

❗ Be sure that the battery is the correct size for the amount and type of servos being used. When using a BEC, be sure that it is capable of delivering constant voltage and can accept enough current that will be used by the RX and servos.

⊘ Do not use a dry cell battery with this receiver.

Antenna installation precaution

⚠ WARNING

⊘ Don't cut or bundle the receiver antenna wire.

⊘ Don't bend the coaxial cable. It causes damage.

❗ The antennae must be installed in a way that ensures they are not under strain.

❗ Keep the antenna as far away from the motor, ESC and other noise sources as you possibly can.

Antenna installation for carbon fuselage

⚠ WARNING

❗ You must leave 30mm at the tip of the antenna fully exposed. The exposed antenna should be secured so that it cannot move around or back inside of your aircraft.

Connect precaution

⚠ DANGER

⊘ Don't connect a connector, as shown next.

• The connector will short circuit if it is connected in this way. A short circuit across the battery terminals may cause abnormal heat and possibly fire.

Receiver



⊘ Do not insert either a switch or battery in this manner.

INSTALLATION OF THE BATTERY

The T6L Sport transmitter is designed to work with four (4) AA alkaline dry cell batteries. AA alkaline batteries are available at any local hobby shop or grocery store and need to be purchased separately.

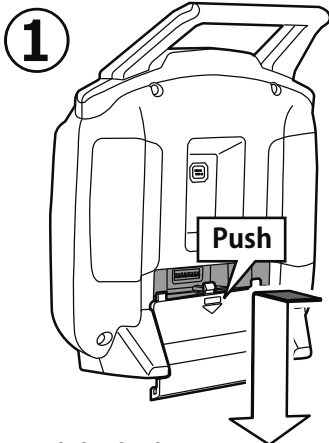

Slide the battery cover off the transmitter in the direction of the arrow in the figure.

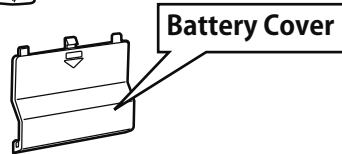
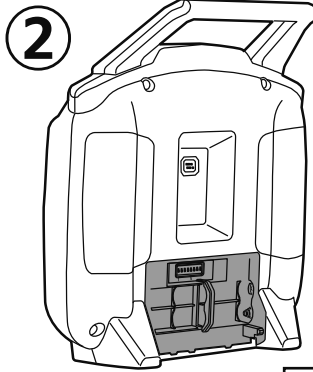

Check:

Turn the power switch on the transmitter to the ON position. Check the display on the monitor LED. If the LED is blinking or OFF, check the batteries for insufficient contact or incorrect battery polarity.

Disposal of the Dry Cell Batteries:

The method to dispose of used dry cell batteries depends on the area in which you reside. Dispose of the batteries in accordance with the regulations for your area.

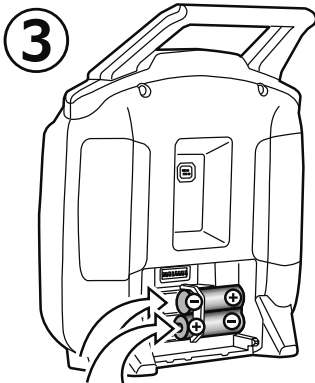

Load the new AA size batteries.

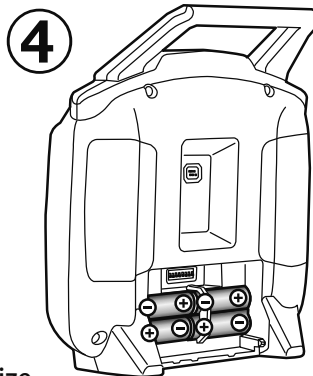

Pay very close attention to the polarity markings and insert accordingly.

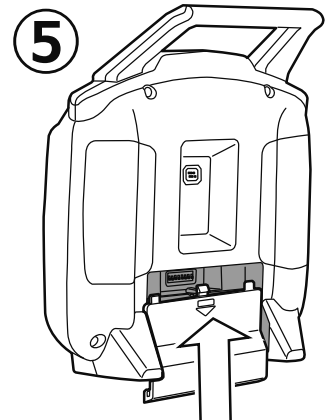

Slide the battery cover back onto the case.

⚠ CAUTION

⚠ Always be sure you reinsert the batteries in the correct polarity order. If the batteries are loaded incorrectly, the transmitter may be damaged.

⚠ Remove the batteries whenever the transmitter will not be in use. If the batteries do happen to leak, clean the battery case and contacts thoroughly. Make sure the contacts are free of corrosion.

TRANSMITTER POWER ON/OFF (Fail safe setting)

When turning on the power of the transmitter. The status of the transmitter is displayed by the LED at the upper part of the front of a transmitter.

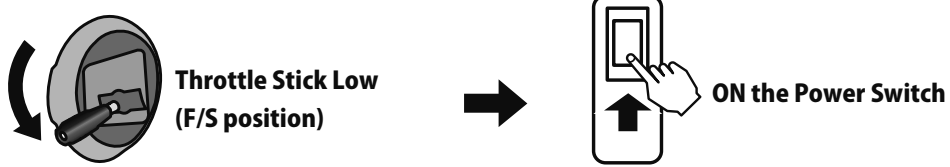

The throttle position when turning on a receiver power supply will be a fail-safe position. The throttle moves to this (low) position in an emergency.

If the power switches are turned off in the opposite order, the model may unexpectedly run out of control and cause a very dangerous situation.

Turning on the power switches

1. Throttle stick to the low (F/S) position.
2. Turn on the transmitter power switch.
3. Turn on the receiver or motor controller switch.

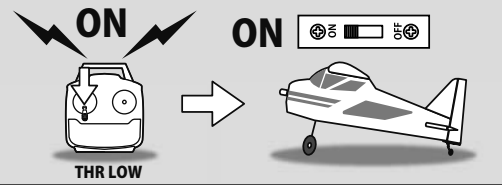

Turning off the power switches

- Always be sure the motor/engine is stopped.
- 1. Turn off the receiver or motor controller switch.
- 2. Then turn off the transmitter power switch.

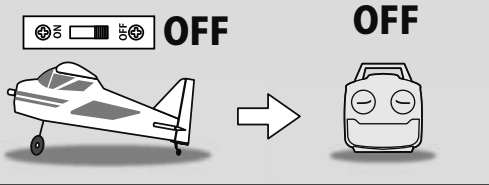

MONITOR LED STATE

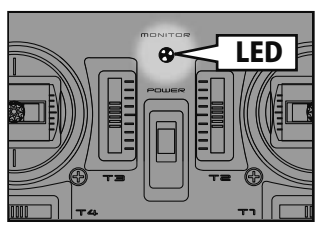

Status	LED
ON	Solid
Low Battery	Once 0.25s ON - Once 0.25s OFF
Power Down Mode	Once 0.5s ON - Once 0.5s OFF
Link Mode	Once 1s ON - Once 1s OFF

STICK CONTROL

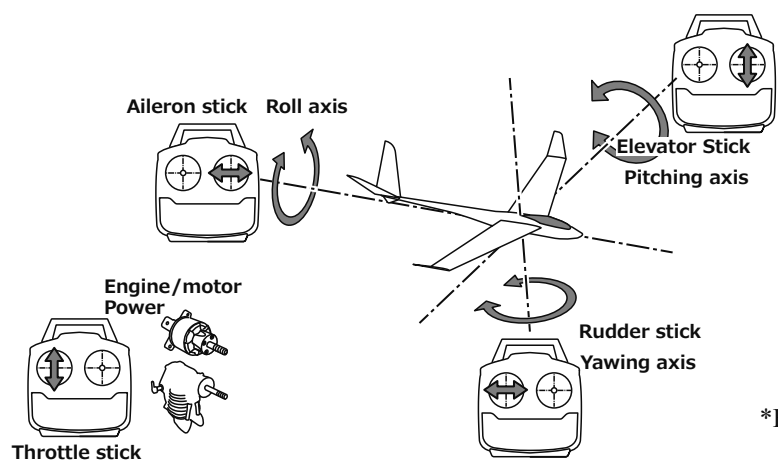

*Example Stick Mode 2

Stick control : Airplane Example

*Example Stick Mode 2

A general model example. (It depends on each plane types.)

Roll axis Control

Right roll
The right aileron is up.
The left aileron is down.

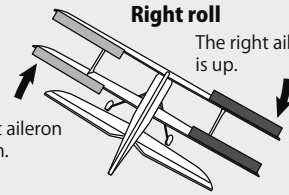

Aileron stick
↓
To the right



Level flight



Neutral



Left roll
The left aileron is up.
The right aileron is down.

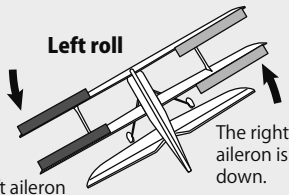

Aileron stick
↓
To the left



Pitch axis Control

Nose Up

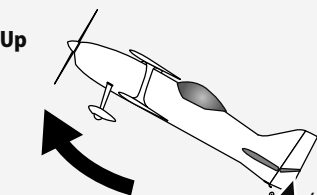

Elevator stick
↓
UP
(moved to the bottom)



Elevator is up.

Level flight

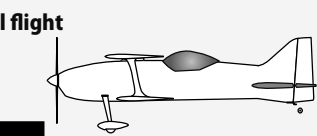

Neutral



Elevator is down.

Nose Down

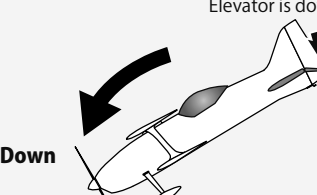

Elevator stick
↓
DOWN
(moved to the top)



Yaw axis Control

Nose Right

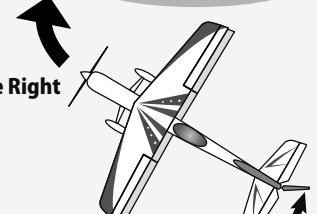

Rudder stick
↓
To the right



The rudder is right.

Straight

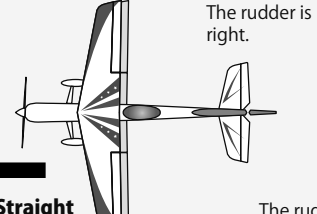

Neutral



The rudder is left.

Nose Left

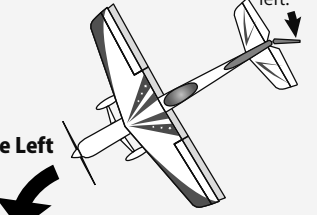

Rudder stick
↓
To the left



Throttle Control

High

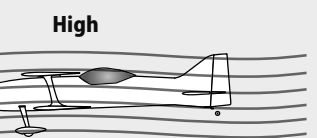

Throttle stick
↓
HIGH
(moved to the top)



Middle

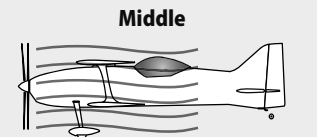

Throttle stick
↓
MIDDLE
(neutral)



Low

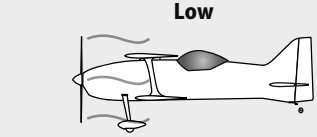

Throttle stick
↓
LOW
(moved to the bottom)



TRIM

There are four trim levers (“trims”) on the front of the transmitter. These trims are for adjusting the neutral position of the aileron, elevator and rudder servos and for setting the idle r.p.m. of the engine when the throttle stick is all the way down. The intended use of the trims is to make small servo adjustments, in flight, to get the model properly “trimmed” (so it will fly straight-and-level). Simply push or pull on the trim levers while flying and the neutral position of the servos will shift. Keep in mind that you should start out with the control surfaces centered when the servos are centered and the trims are “zeroed” (or near zero).

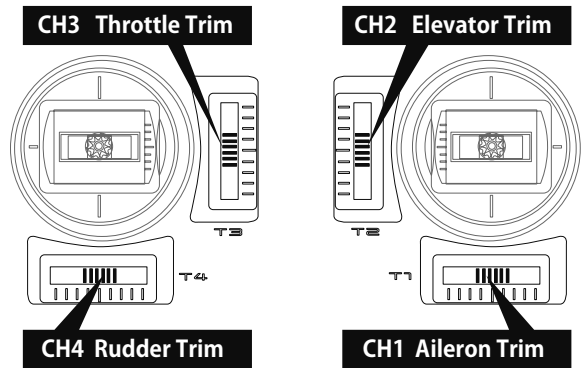

Trim operational example

*Example Stick Mode 2

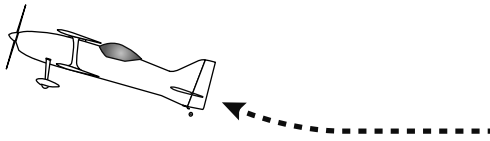

◆When the airplane goes up while the elevator stick is neutral.



◆When the airplane dives while the elevator stick is neutral.

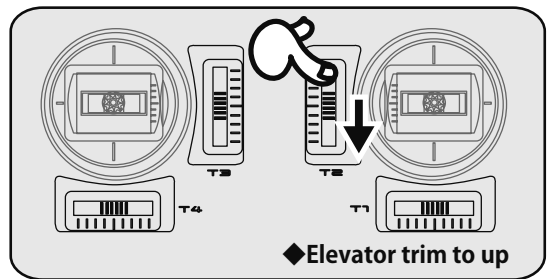
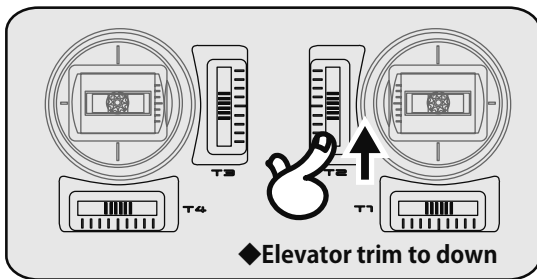

Elevator neutral

Down

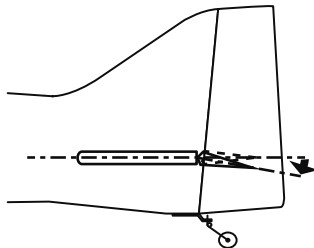

Elevator neutral

Up

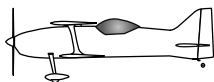
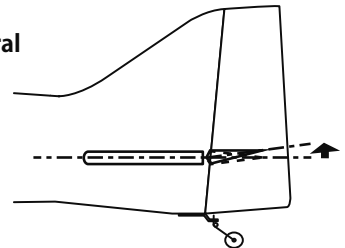

◆Adjust so that the airplane flies level.

CHANNEL 5 SWITCH

This switch operates the servo connected to channel 5 in the receiver. If your model has retractable landing gear, this is the control used to extend and retract the gear.

Movement of channel 5 is only simple on - off.

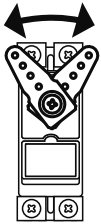

CH5

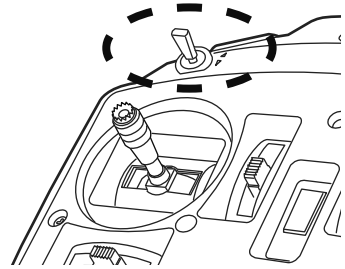
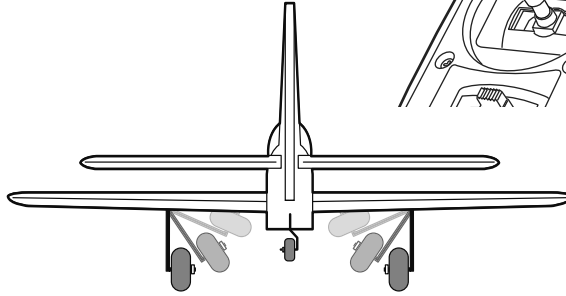
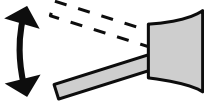

CHANNEL 6 DIAL

This dial operates the servo connected to channel six in the receiver. If your model is equipped with flaps, this is the control used to operate them.

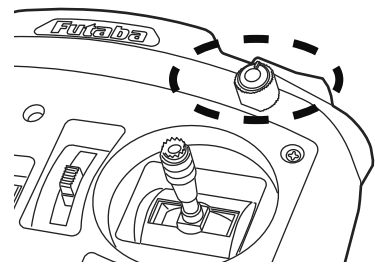
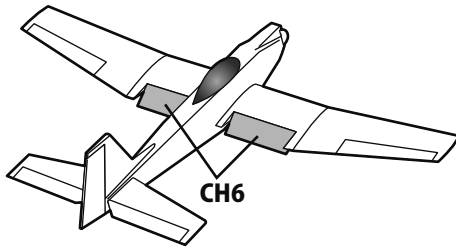

TRAINER FUNCTION (Student only)

Trainer cord available separately

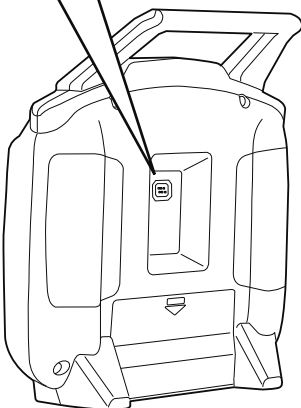

The T6L Sport-2.4GHz trainer function lets you practice flying as a student by connecting the T6L Sport-2.4GHz to the instructor's Futaba transmitter. To utilize the trainer function, the appropriate trainer cord (available separately) and a second Futaba transmitter (usually provided by your flight instructor or R/C club) will be required. When two radios are connected with the trainer cord, they are both capable of operating the model, but it's usually best for the instructor to hold the radio that has been setup for the plane to be flown (as it is already programmed to fly the model). When the instructor holds the trainer switch on his radio, the student will have control. When the instructor wishes to regain control he simply releases the switch. Then he will have immediate, full control.

Power application isn't done from teacher's transmitter. Student's T6L Sport also turns on a power supply.

LINK PROCEDURE

Each transmitter has an individually assigned, unique ID code. In order to start operation, the receiver must be linked with the ID code of the transmitter with which it is being paired. Once the link is made, the ID code is stored in the receiver and no further linking is necessary unless the receiver is to be used with another transmitter. When you purchase additional receivers, this procedure is necessary; otherwise the receiver will not work.

- 1 Place the transmitter and the receiver close to each other within 20 inches (half meter).

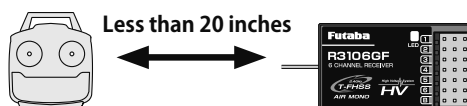

- 2 To activate the "Link Mode".

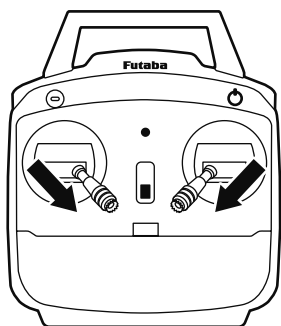

Operate both sticks fully in the bottom and the inside, in the power off state.

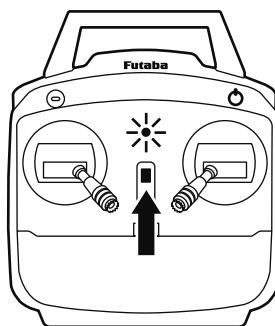

Turn on the power switch.

Transmitter in
"Link Mode"

Transmitter LED blinking
Once 1s ON - Once 1s OFF

Enters the link mode
for 15 seconds

- 3 Immediately turn on the receiver power.

The receiver will enter the linking state (LED blinks red) about 3 seconds after the receiver power is turned on.

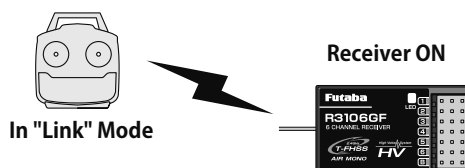

- 4 The LED changed from red to a steady green light, linking is complete. (A linking process is ended in 15 seconds.)

- 5 Check system operation. If the transmitter and receiver are not linked, try linking again.

*If there are many T-FHSS Air systems turned on in close proximity, your receiver might have difficulty establishing a link to your transmitter. This is a rare occurrence. However, should another T-FHSS Air transmitter/receiver be linking at the same time, your receiver could link to the wrong transmitter. This is very dangerous if you do not notice this situation. In order to avoid the problem, we strongly recommend you double check whether your receiver is really under control by your transmitter.

* The R3106GF uses the T-FHSS Air (Mono directional) system so if used with another T-FHSS Air transmitter, then the ID of the R3106GF receiver will not be shown on the transmitter's display. A "NO LINK" indication or the ID of a previously linked T-FHSS Air receiver will be shown. Nevertheless, if the LED on the R3106GF displays a steady green light it is linked with a transmitter. (Telemetry can not be used on the R3106GF.)

WARNING

ⓘ After the linking is done, please cycle receiver power and check that the receiver to be linked is really under the control of the transmitter.

⊘ Don't perform the linking procedure with motor's main wire connected or with the engine operating as it may result in serious injury.

POWER DOWN MODE

A range check must be performed before the first flight of a new model. It is not necessary to do a range check before every flight (but is not a bad idea to perform a range check before the first flight of each day). A range check is the final opportunity to reveal any radio malfunctions, and to be certain the system has adequate operational range.

We have installed a special "Power Down Mode" in the T6L Sport in order to perform an operational ground range check. During this mode, the RF power is reduced in order to test the operational range of the T6L Sport.

To activate the power down mode and perform a range check:

1 To activate the "Power Down Mode"

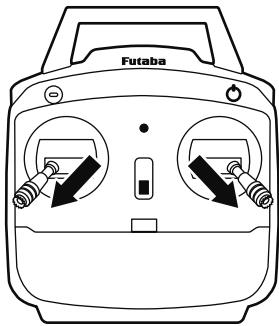

Operate both sticks fully in the bottom and the inside, in the power off state.

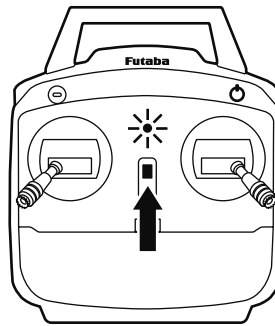

Turn on the power switch.

Transmitter in
"Power down Mode"

Transmitter LED blinking
Once 0.5s ON - Once 0.5s OFF

Keep the throttle stick
low. If the throttle stick
is up, power down mode
will stop.

Enters the link mode
for 90 seconds

2 With the "Power Down Mode" activated, walk away from the model while simultaneously operating the controls. (Keep the throttle stick low.) Have an assistant stand by the model and signal what the controls are doing to confirm that they operate correctly. You should be able to walk approximately 10m (33ft) from the model without losing control.



walk approximately
10m (33ft)

In "Power Down" Mode
keep the throttle stick
low.



3 If everything operates correctly, return to the model. Set the transmitter in a safe, yet accessible location so it will be within reach after starting the engine. Be certain the throttle stick is all the way down, then start the engine. Perform another range check with your assistant holding the plane and the engine running at various speeds. If the servos jitter or move inadvertently, there may be a problem. Do not fly the plane! Look for loose servo connections or binding pushrods. Also be certain that the battery has been fully charged.

4 NEVER start flying in the Power Down mode. To be safe, cycle the power off then back on when ready to fly.

DANGER

 NEVER start flying when the "Power Down Mode" is active.

*Control is impossible and your model will crash.

SERVO REVERSING

The servo reverse switches are used to change the direction that a servo responds to a control input from the transmitter (each stick). After using the reversing function, check all the controls on the model to be certain they are operating in the correct direction and that you did not inadvertently reverse a servo other than the one intended. Reversing the wrong servo (and not checking the response of the controls before each flight) may be the most common cause of a crash!

***Note** that the direction of the aileron servo is easily mistaken.

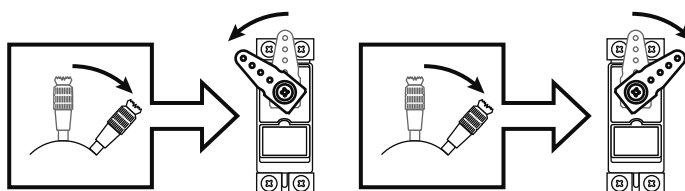
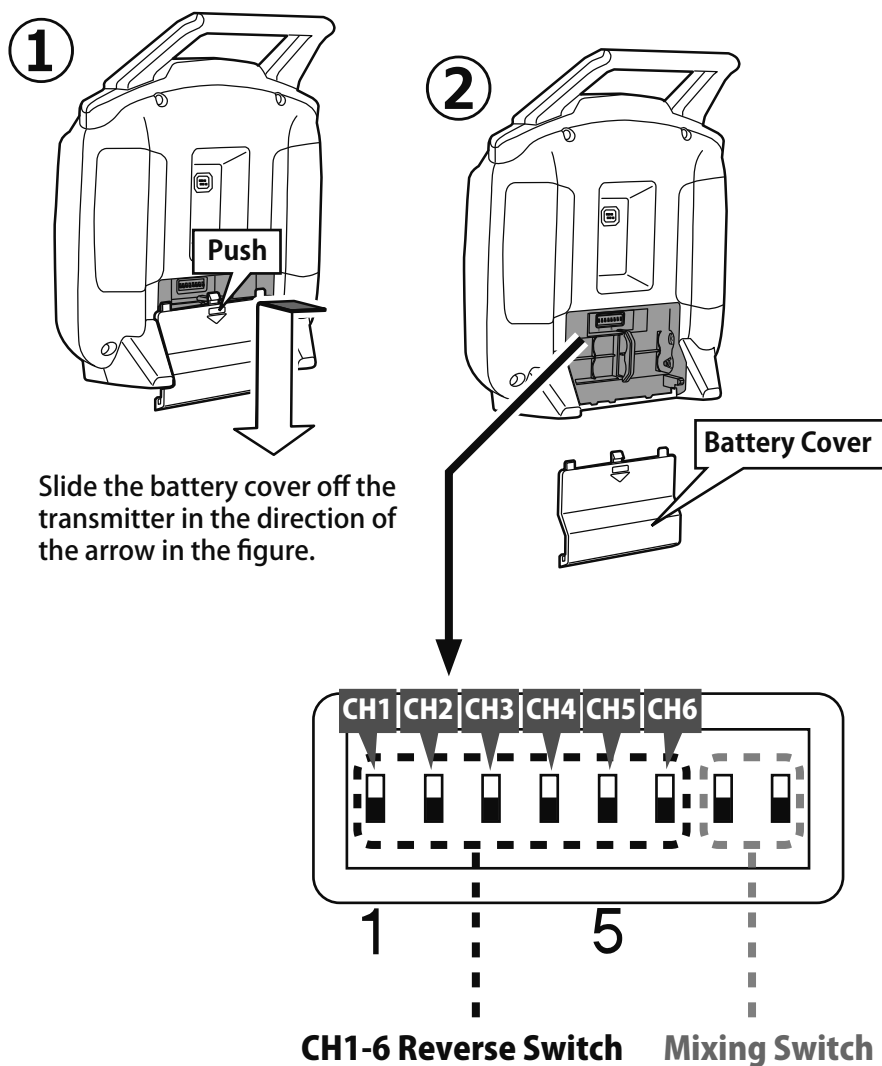

ELEVON MIXING

Intended for tailless, “flying wing” models such as delta wings and flying wings, elevon mixing mixes channel 1 (aileron) to channel 2 (elevator) allowing the elevons to operate in unison (as elevators) or in opposition (as ailerons). This function requires that each elevon be operated by a separate servo.

* If necessary, use the Servo Reversing function to achieve the correct direction of servo throws.

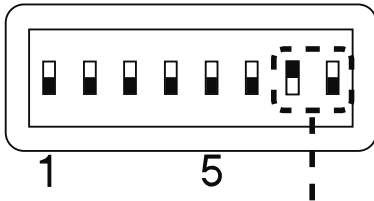
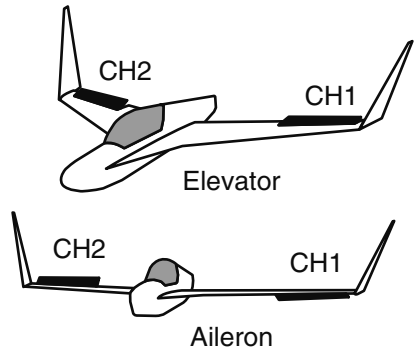

7th switch, the top
8th switch, the bottom

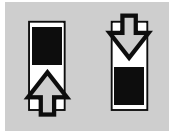

V-TAIL MIXING

This mixing is used with V tail aircraft that combine the elevator and rudder functions.

* If necessary, use the Servo Reversing function to achieve the correct direction of servo throws.

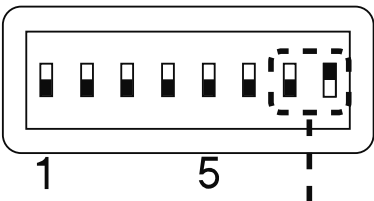
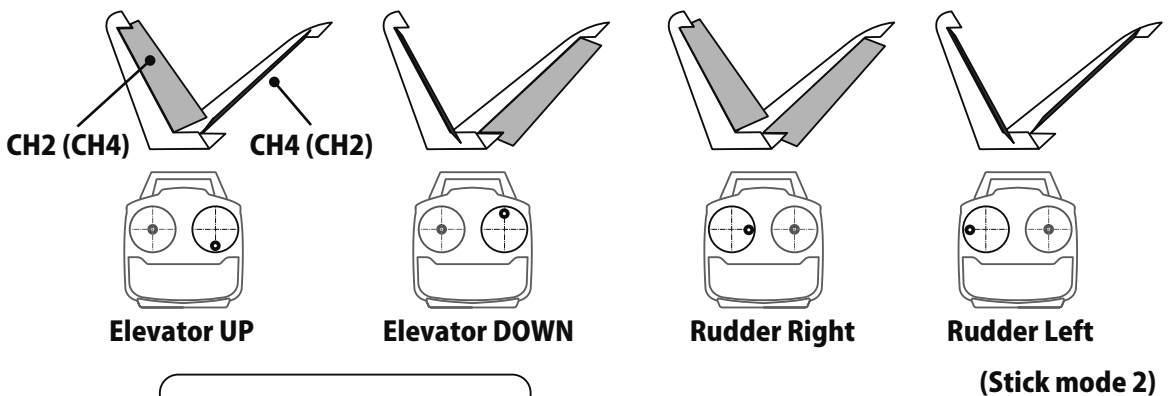

7th switch, the bottom
8th switch, the top

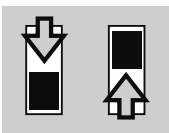

FLAPERON MIXING

The ability to use separate servos to function in the same movement direction to control the flap deflection and to work in opposing directions as ailerons is known as flaperons. Again, this function allows the ailerons to be used both as ailerons and as flaps. Flap control is assigned to Channel 6, the proportional Dial on the front of the transmitter. As such, if flaps are desired, Channel 6 must be used as the additional aileron/flap channel. Ailerons are controlled, of course, by the aileron stick accordingly.

*If necessary, use the Servo Reversing function to achieve the correct direction of the servo throws.

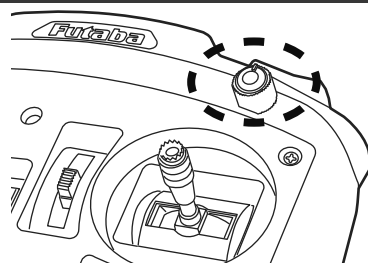

Dial operation

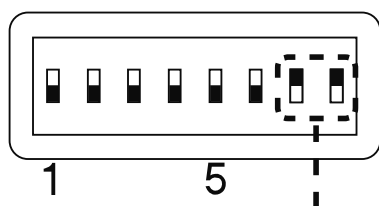
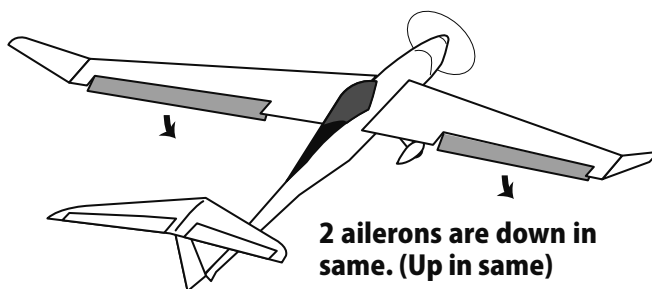

**7th switch, the top
8th switch, the top**

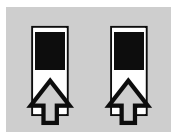

When a mix is not used (NORMAL)

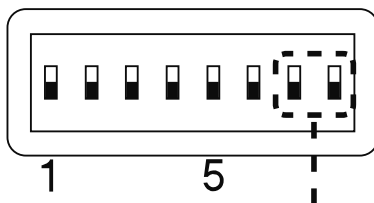

**7th switch, the bottom
8th switch, the bottom**

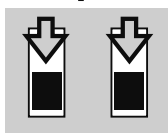

MOUNTING THE RECEIVER SWITCH

When mounting a power switch to an airframe, make a rectangular hole that is a little larger than the total stroke of the switch so that you can turn the switch ON/OFF without binding. Avoid mounting the switch where it can be covered by engine oil and dust. In general, it is recommended to mount the power switch on the side of the fuselage that is opposite the muffler.

SAFETY PRECAUTIONS when you install receiver and servos

⚠ WARNING

Connecting connectors

- ❗ Be sure to insert the connector until it stops at the deepest point.

How to protect the receiver from vibration and water

- ❗ Wrap the receiver with something soft such as foam rubber to avoid vibration. If there is a chance of getting wet, put the receiver in a waterproof bag or balloon to avoid water.

Servo throw

- ❗ Adjust your system so that pushrods will not bind or sag when operating the servos to the full extent.

*If excessive force is continuously applied to a servo, the servo could be damaged due to force on the gear train and/or power consumption causing rapid battery drain.

Mounting servos

- ❗ Use a vibration-proof rubber (such as rubber grommet) under a servo when mounting the servo on a servo mount. And be sure that the servo cases do not touch directly to the metal parts such as servo mount.

*If the servo case contacts the airframe directly, vibration will travel to and possibly damage the servo.

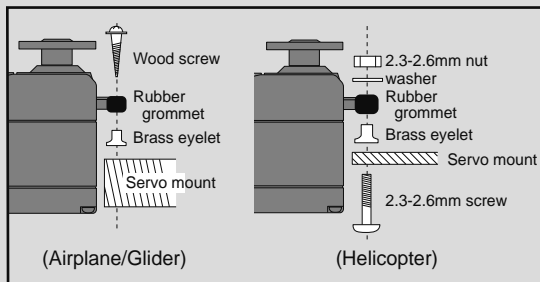

❗ Servo lead wires

To prevent the servo lead cable from being broken by vibration during flight, provide a little slack in the cable and fasten it at suitable points. Periodically check the cable during daily maintenance.

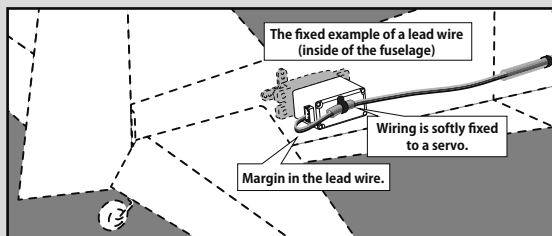

CHANGE TO MODE 1

The following sequence illustrates how to change the T6L from 'Mode 2' into 'Mode 1'. The ratchet mechanism must be changed to the other side. This can be difficult to perform so if in doubt please contact your local Futaba Service center.

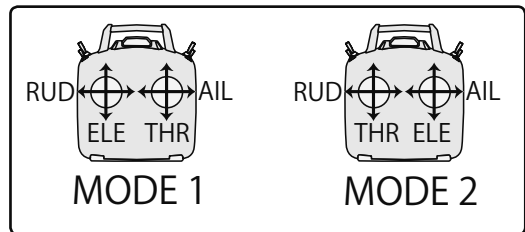

- 1** Open the battery cover on the back of the transmitter and remove the transmitter battery.

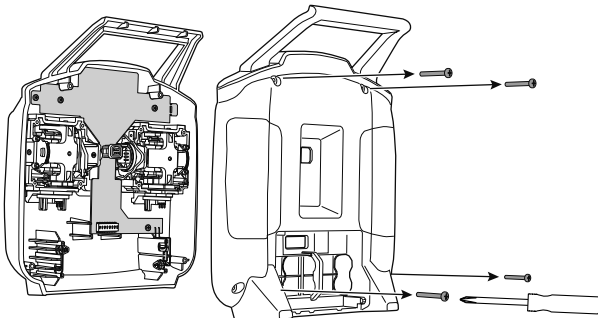

- 2** Remove the four transmitter rear case screws and remove the rear case.

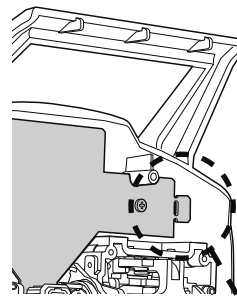

- 3** This part is cut.

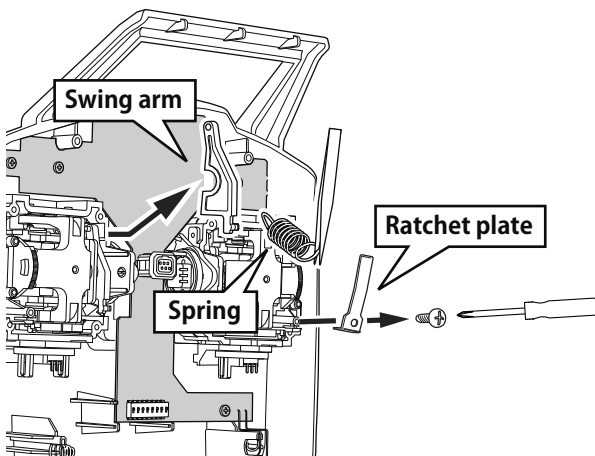
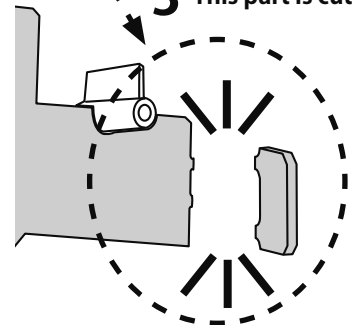

- 4** Remove the ratchet plate /swing arm/spring on the gimbal section.

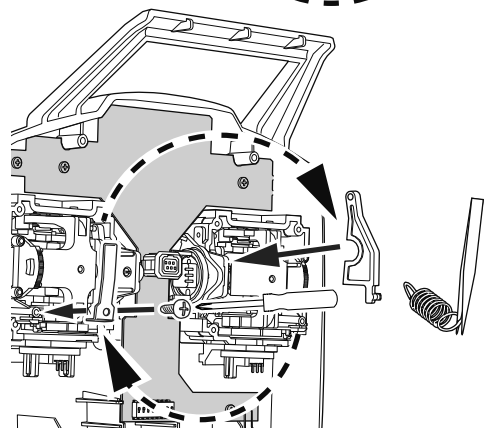

- 5** Change the ratchet plate /swing arm/spring on the gimbal section.

- 6** Install the rear case.

TECHNICAL SPECIFICATIONS

Transmitter T6L Sport

2-stick, 6-channel, T-FHSS Air (Mono directional)-2.4G system

Transmitting frequency: 2.4GHz band

System: T-FHSS Air (Mono directional), No telemetry

Power supply: 6.0V Dry battery

Receiver R3106GF

T-FHSS Air (Mono directional)-2.4G system, No telemetry

Power requirement: 4.8V-7.4V battery or regulated output from ESC, etc. (*1)

Size: 1.7 x 0.98 x 0.35 in. (43.1 x 25.0 x 8.8 mm)

Weight: 0.3 oz. (7.8g)

(*1) When using ESC's make sure that the regulated output capacity meets your usage application.

Compliance Information Statement (for EU)

Declaration of Conformity

Hereby, Futaba Corporation declares that the radio equipment type T6L Sport is in compliance with Directive 2014/53/EU.

The full text of the EU declaration of conformity is available at the following internet address:

<http://www.rc.futaba.co.jp/english/dl/declarations.html>

FUTABA CORPORATION

1080 Yabutsuka, Chosei-mura, Chosei-gun, Chiba-ken, 299-4395, Japan

Phone: +81 475 32 6982, Facsimile: +81 475 32 6983

2017, 2 (1)