



BLAST

Best mode for normal driving. Only use until confident with the car.
 Beste Einstellung für normales Fahren. Nur verwenden, wenn Sie sich mit dem Fahrzeug sicher fühlen.
 Meilleur mode de conduite normale. Utiliser ce mode jusqu'à ce que vous soyez à l'aise avec la voiture.

- Balanced handling
- Maximum stability
- Best for jumping
- Maniabilité efficace
- Stabilité maximale
- Meilleur pour les sauts

- Ausgewogenes Handling
- Maximale Stabilität
- Bestens fürs Springen geeignet



NERO

START HERE
 HIER BEGINNEN
 COMMENCER ICI

UPGRADE PARTS TUNINGTEILE PIÈCES DE MISE À JOUR



WHEELIE

Best mode for wheelies.
 Beste Einstellung für Wheelies.
 Meilleur mode pour les Wheelies.

- Easy wheelies
- Balanced Handling
- Stronger brakes
- Wheelies faciles
- Maniabilité efficace
- Freinage efficace

- Einfache Wheelies
- Ausgewogenes Handling
- Stärkere Bremsen



- AR310473 - 12T
- AR310474 - 13T
- AR310475 - 14T
- AR310476 - 15T
- AR310477 - 16T
- AR310478 - 17T
- AR310479 - 18T
- AR310480 - 19T
- AR310481 - 20T
- AR310482 - 21T
- AR310483 - 22T

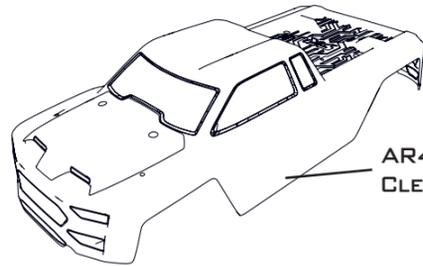
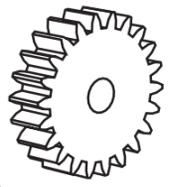

AR406007 CLEAR BODY

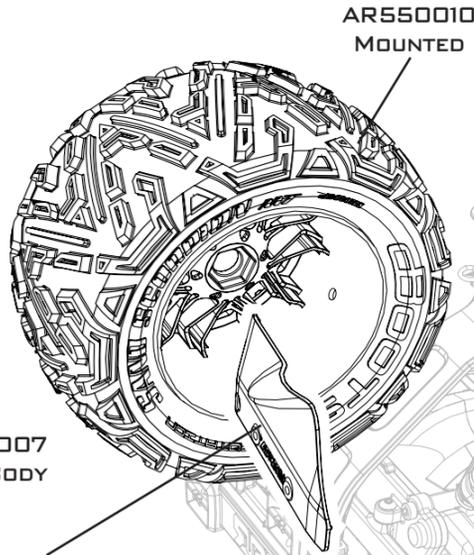

AR330414 DIRT GUARDS

AR330414 DIRT GUARDS

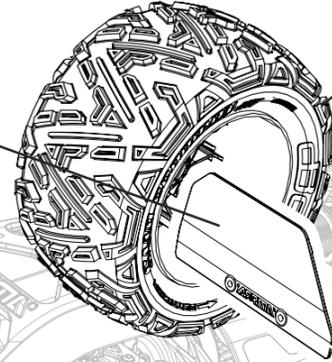

AR550010 MOUNTED

AR320255 WHEELIE BAR

AR330414 DIRT GUARDS

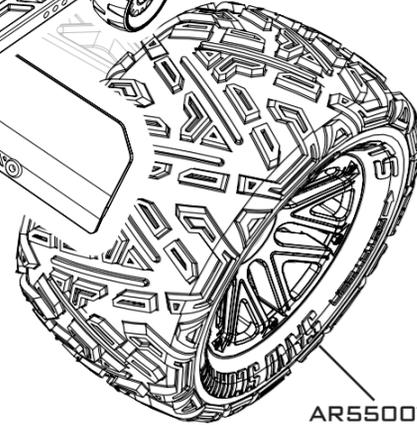

AR550010 MOUNTED

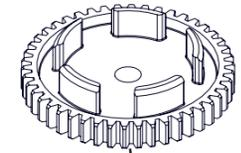

AR310729 MACHINED HEAVY DUTY

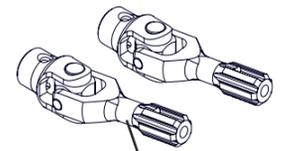

AR310738 HEAVY DUTY



AR340102 ALUMINIUM

AR330414 DIRT GUARDS

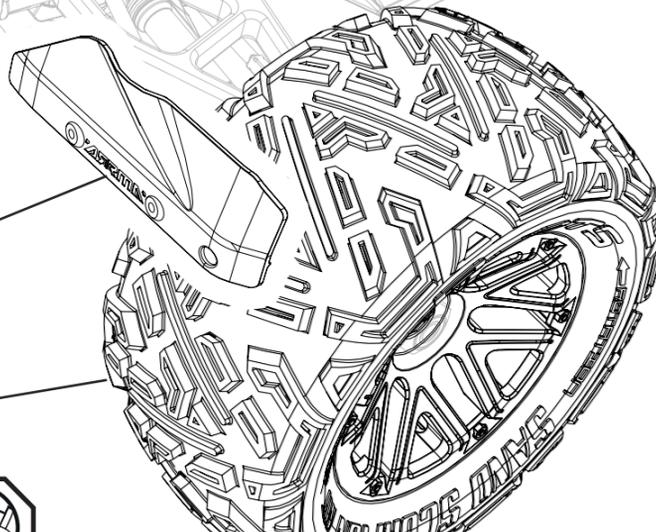

AR550010 MOUNTED

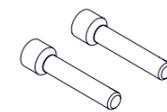

AR310556

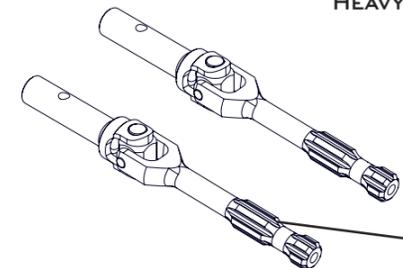

AR310737 HEAVY DUTY

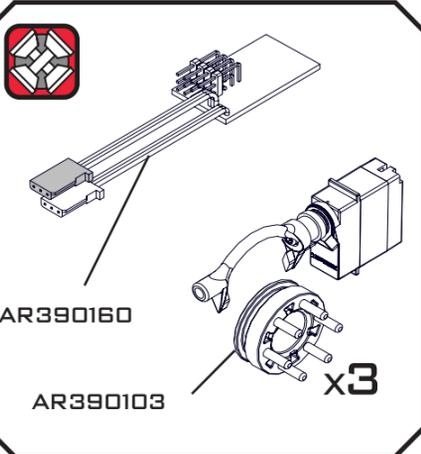

AR390160

AR390103 x3

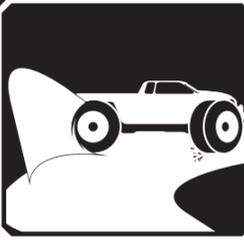

DRIFT

Best mode for drifting and sliding on loose surfaces.
 Beste Einstellung zum Driften auf lockeren Untergründen.
 Meilleur mode pour le Drift sur les surfaces glissantes

- Used at slower speeds
- Least stable
- Hard to drive
- Utiliser avec des vitesses plus lentes
- Moins stable
- Difficile à contrôler

- Zur Verwendung bei niedrigen Geschwindigkeiten
- Geringste Stabilität
- Schwer zu beherrschen



	SPEED	STABILITY	JUMPING	MAINTENANCE
BLAST	▲	▲	▲	▲
WHEELIE	▲	▲	▲	▲
DRIFT	▲	▲	▲	▲
CLIMB	▲	▲	▲	▲



CLIMB

Best mode for climbing or getting out of a tricky situation.
 Beste Einstellung zum Klettern und für schwierige Situationen.
 Meilleur mode pour le franchissement ou pour sortir d'une situation délicate.

- Maximum traction
- Very slow speed driving
- Perfect if you get stuck
- Traction maximale
- Conduite à vitesse très lente
- Parfait si vous êtes bloqué

- Maximale Traction
- Sehr langsame Geschwindigkeit
- Perfekt wenn Sie irgendwo steckengeblieben sind



BLAST

Modo recomendado para una conducción normal. Utilizar únicamente cuando te sientas cómodo con el coche.
 正常行驶的最佳模式，直到对车辆充满信心。
 通常走行に適したモード。唯一の車で自信を持ってまで使用しています。

- 平衡処理
- 最強安定性
- 最佳跳跃性能

- Comportamiento equilibrado
- Máxima estabilidad
- Mejor capacidad de salto
- バランスの取れたハンドリング
- 最大安定性
- 跳躍のためのベスト

EMPEZAR AQUÍ

从此处开始
 ここから始める

NERO

PIEZAS OPCIONALES 升级件 アップグレードパーツ

WHEELIE

Modo recomendado para hacer caballitos.
 抬头的最佳模式
 ウィリーののためのベストモード。

- 简单的抬头
- 平衡处理
- 更强的刹车

- Caballitos fáciles
- Comportamiento equilibrado
- Mejor capacidad de frenada
- 简单ウィリー
- バランス取り扱い
- 強いブレーキ

- AR310473 -12T
- AR310474 -13T
- AR310475 -14T
- AR310476 -15T
- AR310477 -16T
- AR310478 -17T
- AR310479 -18T
- AR310480 -19T
- AR310481 -20T
- AR310482 -21T
- AR310483 -22T

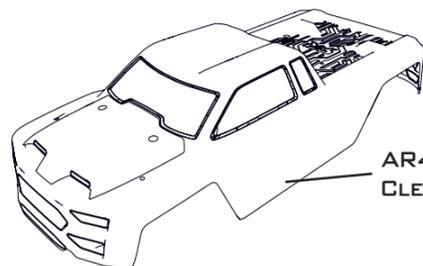
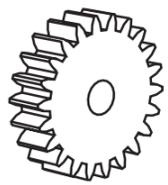

AR406007
 CLEAR BODY

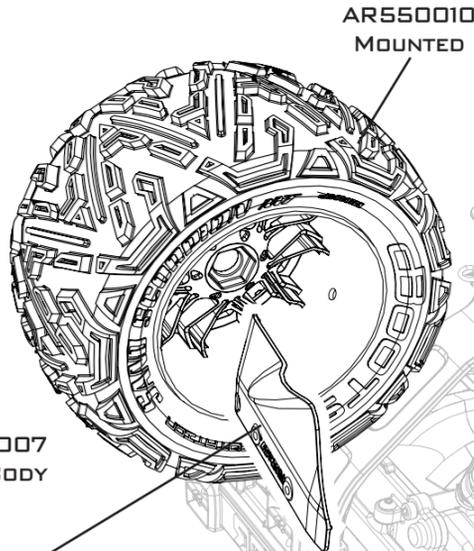

AR550010
 MOUNTED

AR330414
 DIRT GUARDS

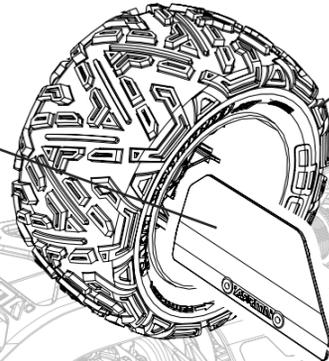

AR550010
 MOUNTED

AR320255
 WHEELIE BAR

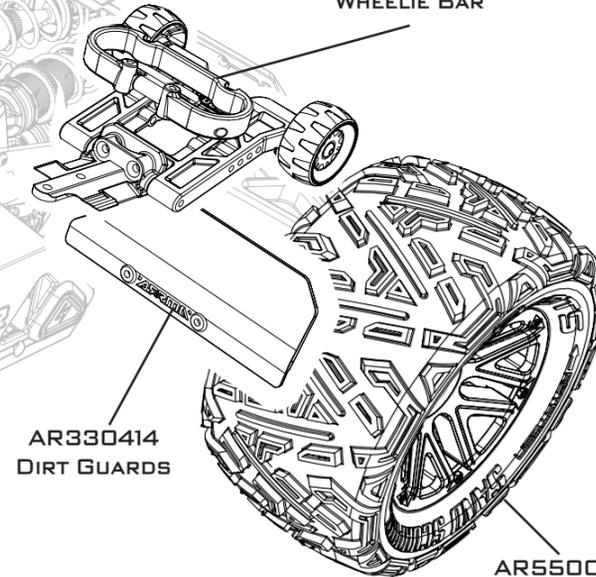

AR330414
 DIRT GUARDS

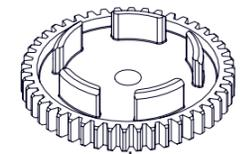

AR310729
 MACHINED
 HEAVY DUTY

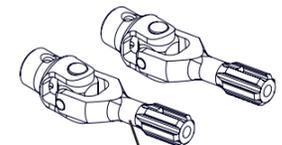

AR310738
 HEAVY DUTY

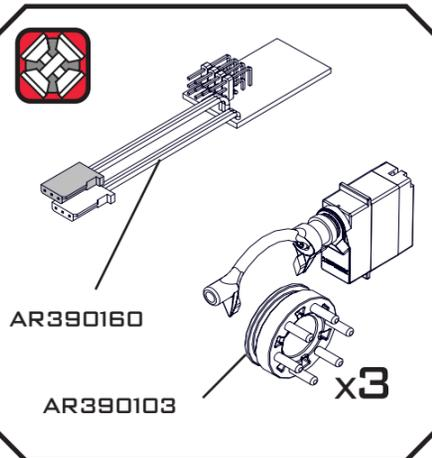

AR390160

AR390103

x3



AR340102
 ALUMINIUM

AR330414
 DIRT GUARDS

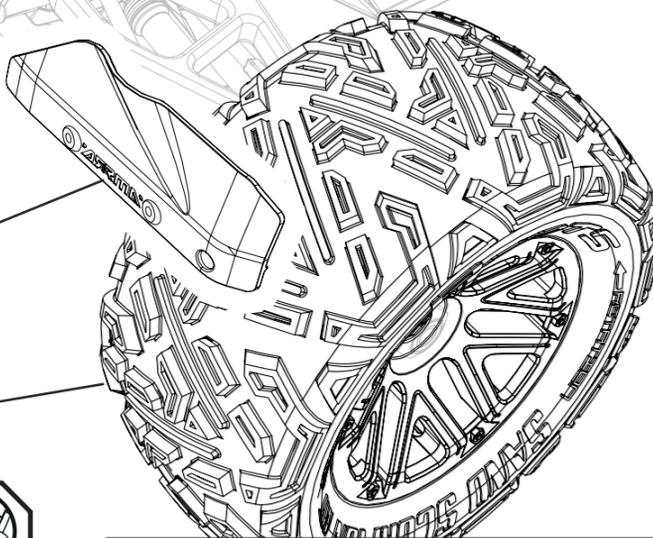

AR550010
 MOUNTED



AR310556

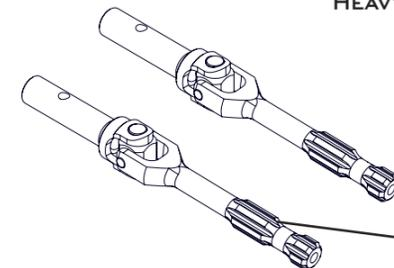

AR310737
 HEAVY DUTY

DRIFT

Modo recomendado para derrapar en superficies sueltas.
 在松软地面上漂移和滑动的最佳模式
 漂流と緩い表面上にスライドさせるためのベストモード。

- 低速时使用
- 最小稳定性
- 难操纵

- Utilizado a velocidades más bajas
- Menor estabilidad
- Difícil de conducir
- 低速で使用
- 少なくとも安定しました
- ドライブするのは難しいです

	SPEED	STABILITY	JUMPING	MAINTENANCE
BLAST				
WHEELIE				
DRIFT				
CLIMB				

CLIMB

Modo recomendado para escalar o salir de una situación complicada.
 爬坡或从复杂状况中出来的最佳模式。
 登山やトリッキーな状況から抜け出すための最良。

- 最大牽引力
- 低速行驶
- 如果车卡住就会显示出完美

- Máxima capacidad de tracción
- Conducción a velocidad muy baja
- Perfecto si te quedas atascado
- 最大トラクション
- 非常に低速走行
- あなたが動けなくなる場合はパーフェクト