



# Instruction Manual book

# CORSAIR



**95% ALMOST READY TO FLY**

## SPECIFICATION

<input type="checkbox"/> Wingspan :	1,760 mm	69.29 in.
<input type="checkbox"/> Length :	1,320 mm	51.97 in.
<input type="checkbox"/> Weight :	4.4 kg	9.68 Lbs.
<input type="checkbox"/> Radio :	06 channels.	
<input type="checkbox"/> Servo :	08 servos.	
<input type="checkbox"/> Engine :	91-120 - 4stroke.	

Made in Vietnam.

This instruction manual is designed to help you build a great flying aeroplane. Please read this manual thoroughly before starting assembly of your **CORSAIR 91**. Use the parts listing below to identify all parts.

## WARNING

***Please be aware that this aeroplane is not a toy and if assembled or used incorrectly it is capable of causing injury to people or property. WHEN YOU FLY THIS AEROPLANE YOU ASSUME ALL RISK & RESPONSIBILITY.***

If you are inexperienced with basic R/C flight we strongly recommend you contact your R/C supplier and join your local R/C Model Flying Club. R/C Model Flying Clubs offer a variety of training procedures designed to help the new pilot on his way to successful R/C flight. They will also be able to advise on any insurance and safety regulations that may apply.

## TOOLS & SUPPLIES NEEDED

- Thick cyanoacrylate glue.
- 30 minute epoxy.
- 5 minute epoxy.
- Hand or electric drill.
- Assorted drill bits.
- Modelling knife.
- Straight edge ruler.
- 2mm ball driver.
- Phillips head screwdriver.
- 220 grit sandpaper.
- 90° square or builder's triangle.
- Wire cutters.
- Masking tape & T-pins.
- Thread-lock.
- Paper towels.

**Some more parts.**

## HARDWARE PACK

COWLING.  
Landing gear.....

## SUGGESTION

To avoid scratching your new airplane, do not unwrap the pieces until they are needed for assembly. Cover your workbench with an old towel or brown paper, both to protect the aircraft and to protect the table. Keep a couple of jars or bowls handy to hold the small parts after you open the bag.

## PARTS LISTING

### FUSELAGE ASSEMBLY

- (1) Fuselage.

### WING ASSEMBLY

- (1) Right wing half with pre-installed aileron.
- (1) Left wing half with pre-installed aileron.

### Tail section assembly

- (1) Vertical stabilizer with pre-installed rudder.
- (1) Horizontal stabilizer with pre-installed elevator halves.

## NOTE.

Please trial fit all the parts. Make sure you have the correct parts and that they fit and are aligned properly before gluing! This will assure proper assembly. **CORSAIR 91** ARF is hand made from natural materials, every plane is unique and minor adjustments may have to be made. However, you should find the fit superior and assembly simple.

The painted and plastic parts used in this kit are fuel proof. However, they are not tolerant of many harsh chemicals including the following: paint thinner, C/A glue accelerator, C/A glue debonder and acetone. Do not let these chemicals come in contact with the colors on the covering and the plastic parts.

**Caution:** this model is not a toy!

If you are a beginner to this type of powered model, please ask an experienced model flyer for help and support. If you attempt to operate the model without knowing what you are doing you could easily injure yourself or somebody else. Please keep your safety and well-being in mind at all times.

**Important: before you start construction**

Even if you have already built a large number of RC models please read right through these instructions and check all the kit components against the parts list. We have taken great trouble to keep construction as simple as possible, without making any compromises in the area of safety.

**Note regarding the film covering**

Minor creases or bubbles may develop in the film covering due to major fluctuations in weather conditions (temperature, humidity etc.); in rare cases you may even find a slight warp in a component. These minor faults are in the nature of film-covered built-up wooden structures, and can easily be corrected using a heat gun, as commonly used for modelling.

Creases: Blow warm air over the area and rub down with a soft cloth.

Wing warp: Hold the panel twisted gently in the opposite direction to the warp, and apply warm air to remove the creases from the covering.

Caution! do not heat the film more than is absolutely necessary. If the air or the iron is too hot, the film may melt and holes may be formed.

This model is highly pre-fabricated and can be built in a very short time. However, the work which you have to carry out is important and must be done carefully. The model will only be strong and fly well if you complete your tasks competently - so please work slowly and accurately.

**When self-tapping screws have to be screwed into wood, apply a little white glue to prevent them shaking loose: just squirt white glue into the hole and fit the screw.**

**SAFETY PRECAUTION.**

- + This is not a toy
- + Be sure that no other flyers are using your radio frequency.
- + Do not smoke near fuel
- + Store fuel in a cool, dry place, away from children and pets.
- + Wear safety glasses.
- + The glow plug clip must be securely attached to the glow plug.
- + Do not flip the propeller with your fingers.
- + Keep loose clothing and wires away from the propeller.
- + Do not start the engine if people are near. Do not stand in line with the side of the propeller.
- + Make engine adjustments from behind the propeller only. Do not reach around the spinning propeller.

**REPLACEMENT LARGE PARTS**

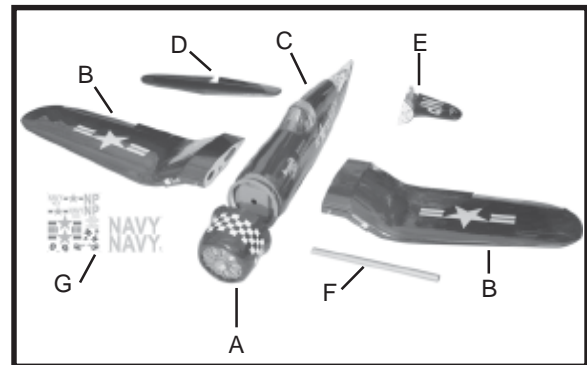

- A. Cowling.
- B. Wing panel.
- C. Fuselage.
- D. Horizon stabilizer.
- E. Vertical stabilizer
- F. Aluminium wing dihedral brace.
- G. Decal sheets.

**REPLACEMENT SMALL PARTS**

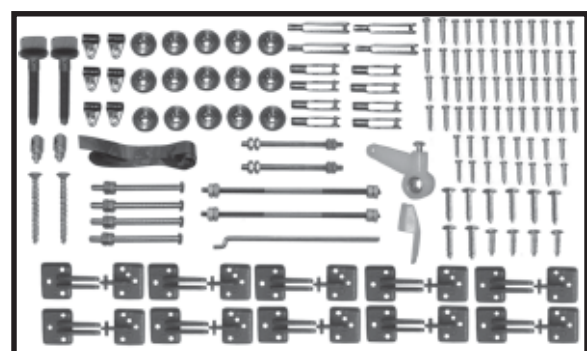

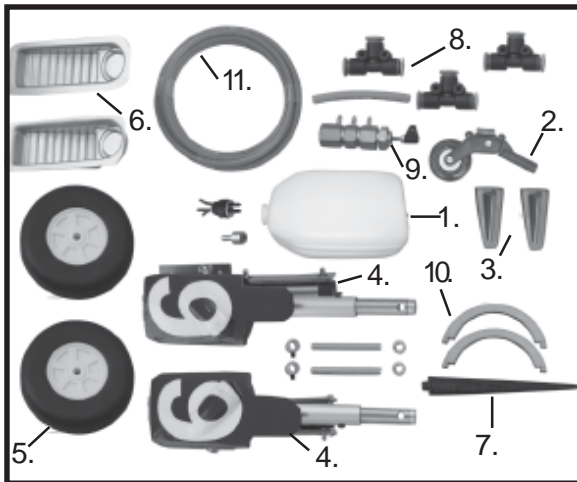

1. Fuel tank.
2. Tail gear.
3. Plastic parts for pushrod.
- 4 . Strut sets.
5. Wheels.
6. Air cool plastic parts.
7. Antenna.
8. Bag with all of the connectors and t-fittings as a set.
9. Air operated switch valve.
10. Plywood cover air tank.
11. Airline.

**I. AILERON.**

**1.INSTALLING THE AILERON SERVOS.**

□ 1) Install the rubber grommets and brass eyelets onto the aileron servos.

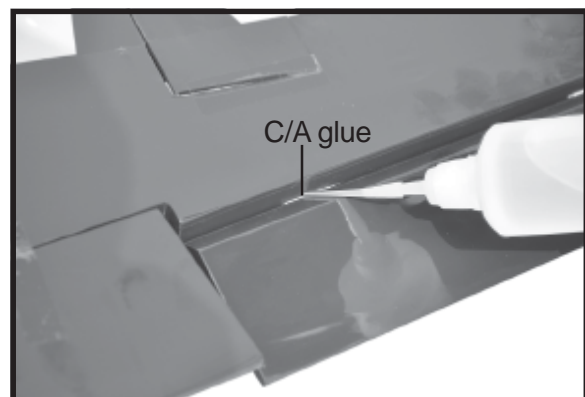
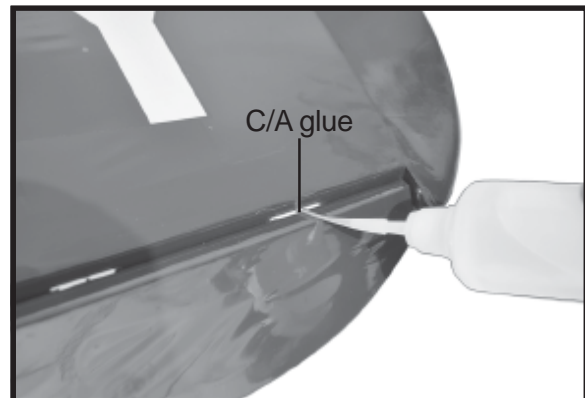
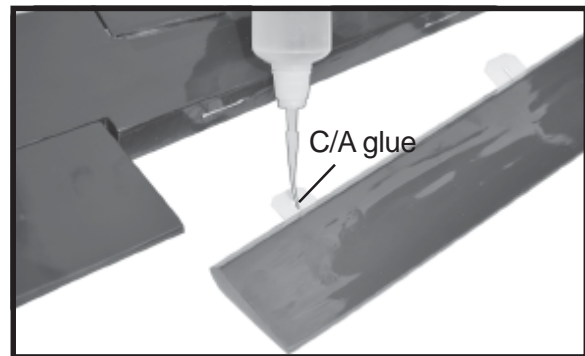
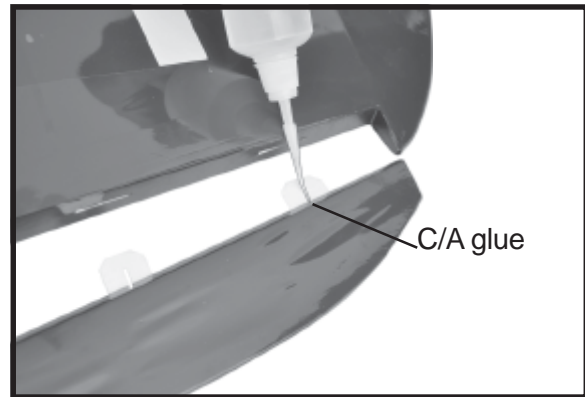
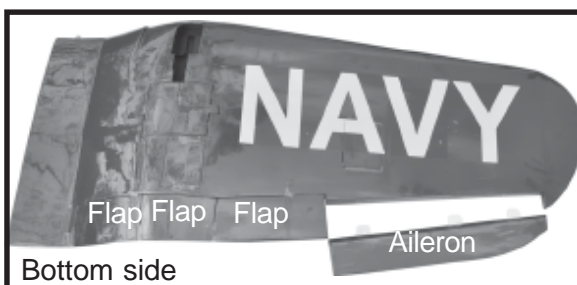
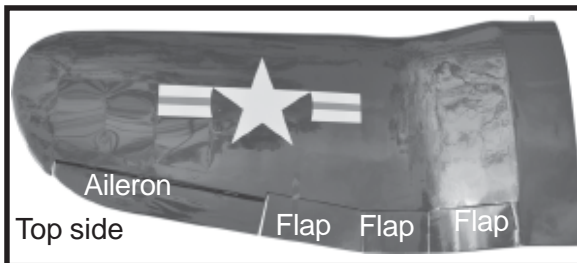





□ 2) Using a modeling knife, remove the covering at position show below.

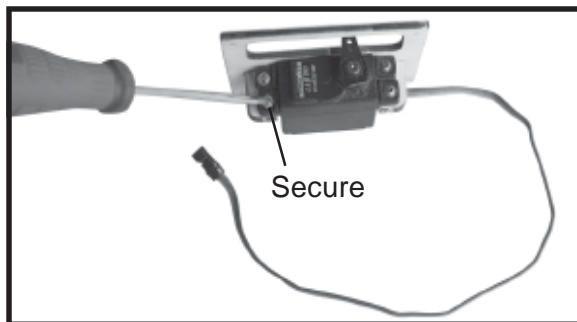
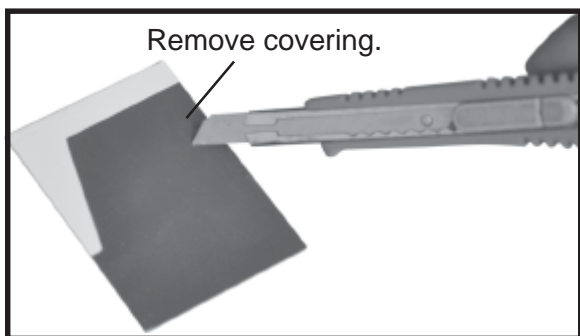

□ 3) Using the thread as a guide and using masking tape, tape the servo lead to the end of the thread: carefully pull the thread out. When you have pulled the servo lead out, remove the masking tape and the servo lead from the thread.

□ 4) Drill 1,6mm pilot holes through the block of wood for each of the four mounting screws provided with the servo.

□ 5. Instal servo tray with aileron servo into the wing as same as picture below.

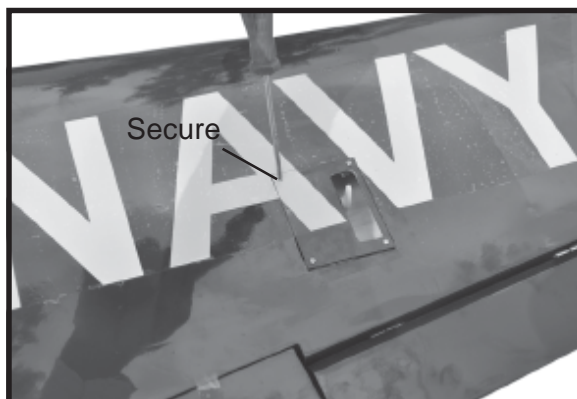
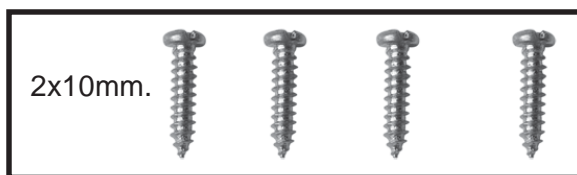
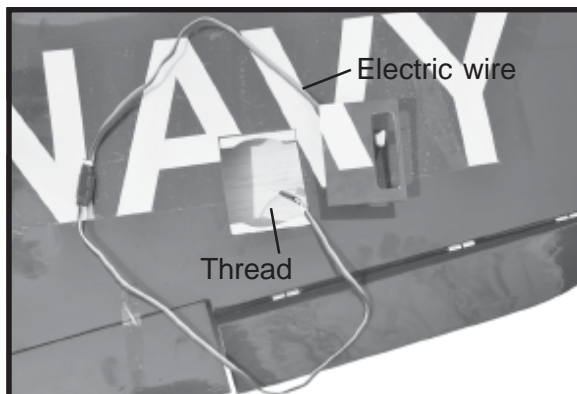

**2.INSTALLING THE AILERON CONTROL HORN.**

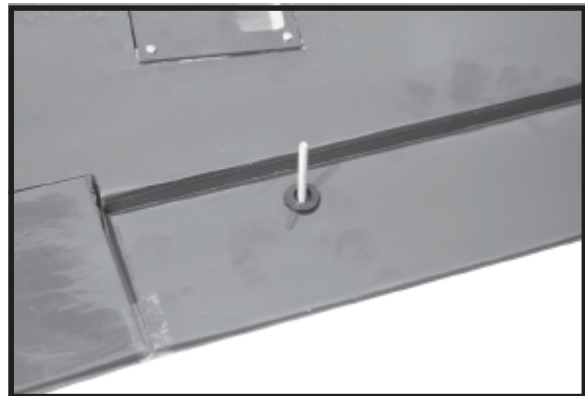
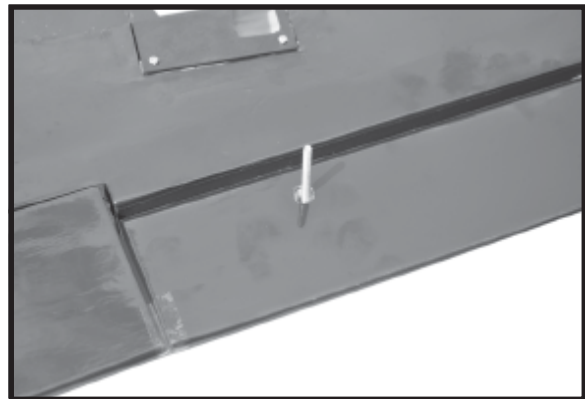
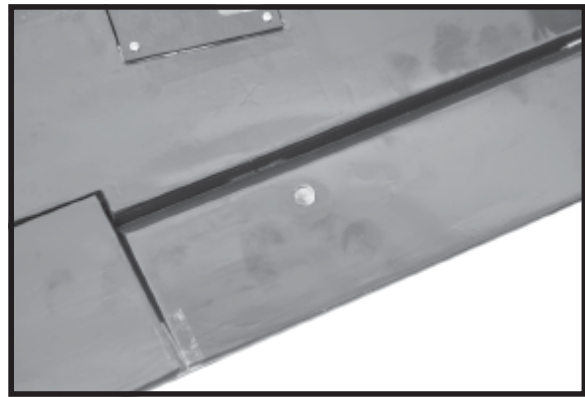

Aileron control horn

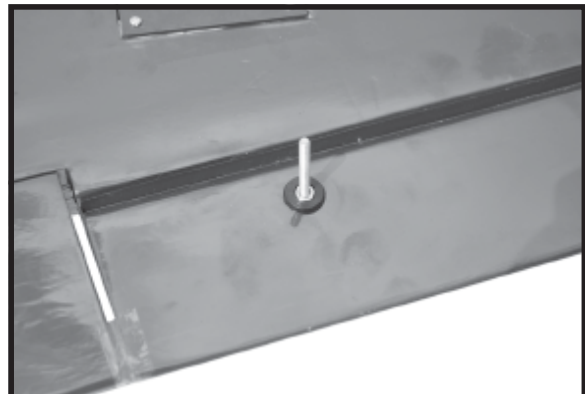
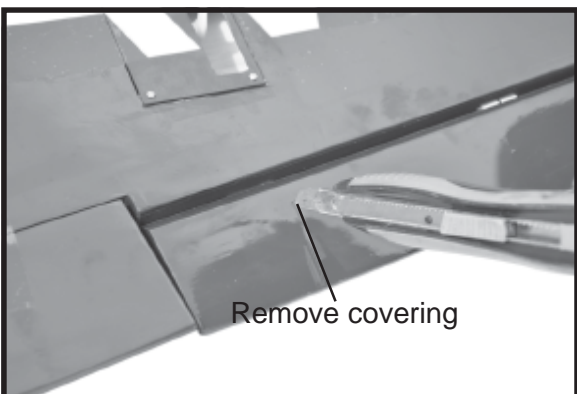

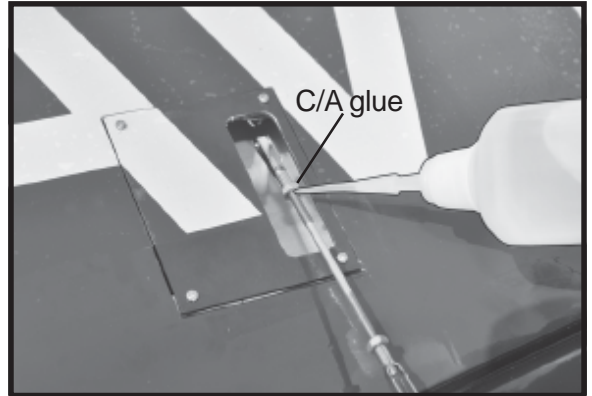
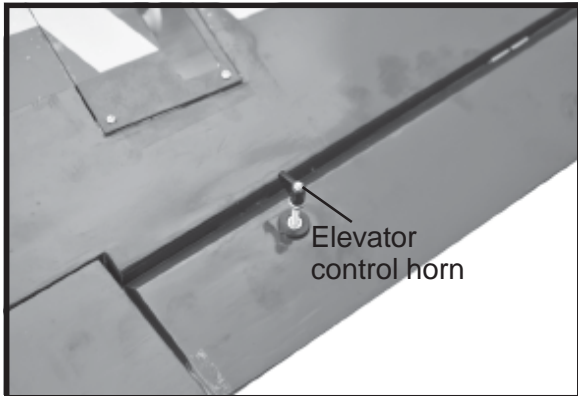
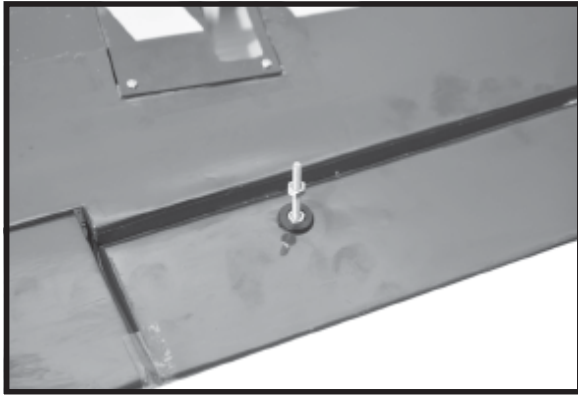

**3.INSTALLING THE AILERON LINKAGES.**

Installing the aileron linkages as pictures below.

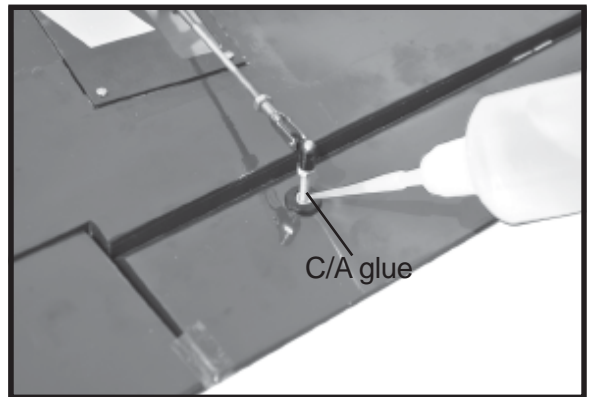
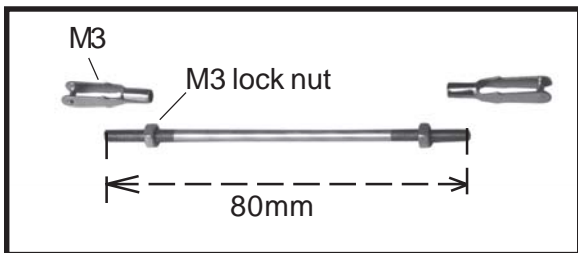

**2- INSTALLING THE FLAP SERVO .**

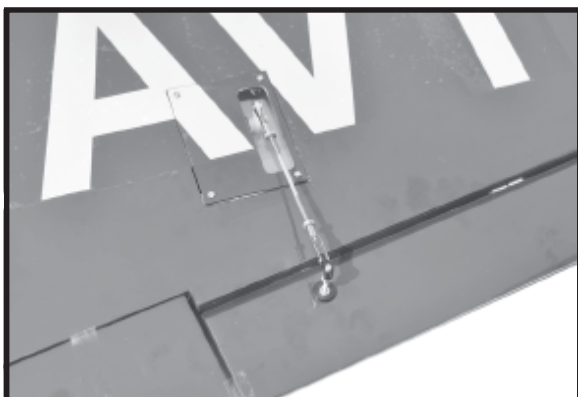
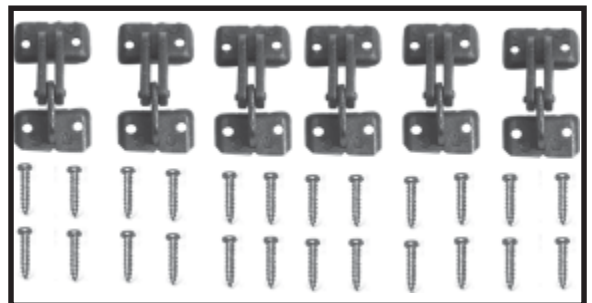

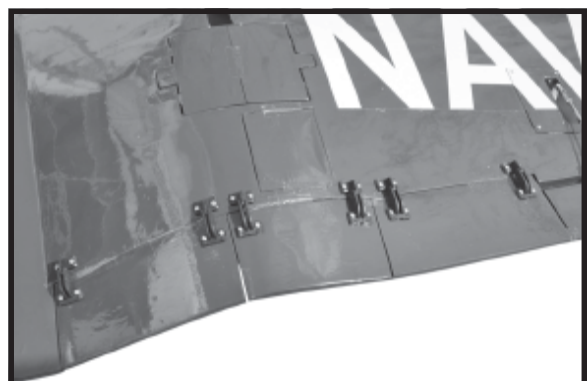
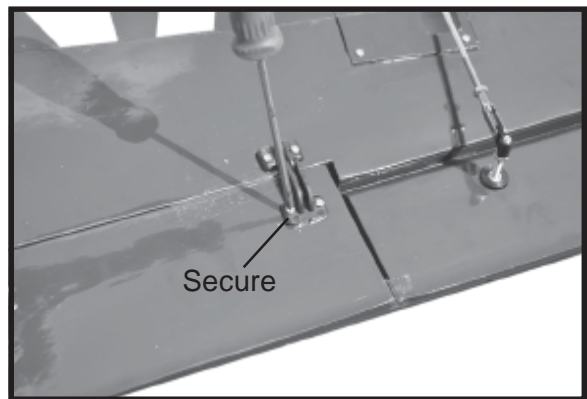
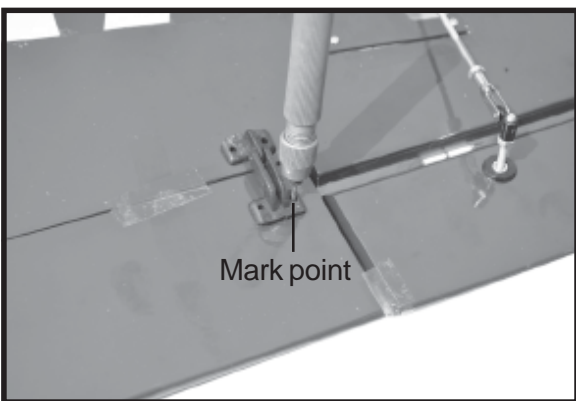
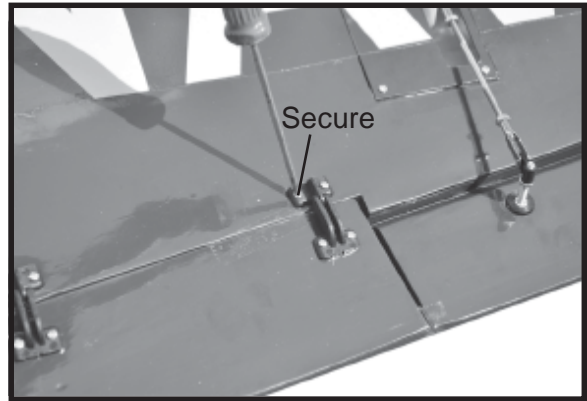
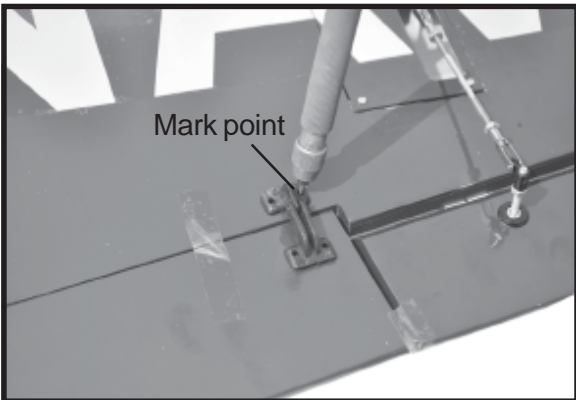
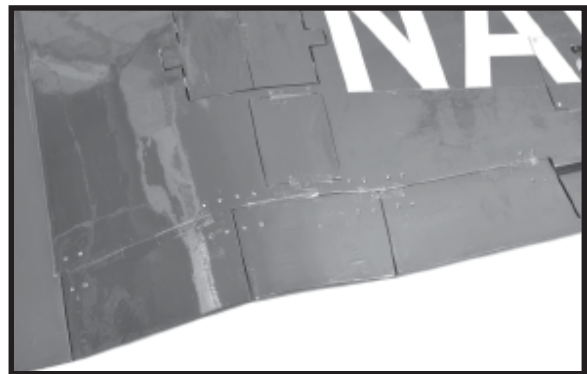
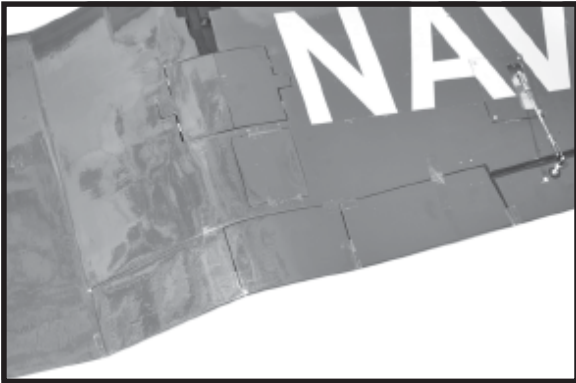
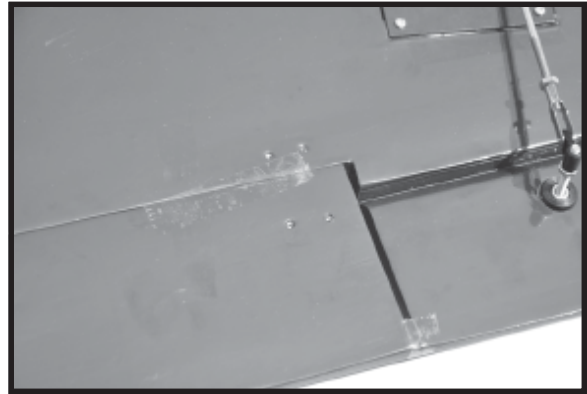
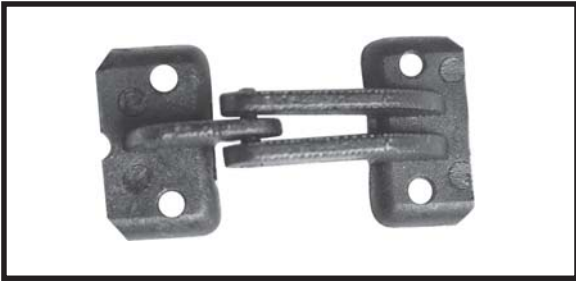



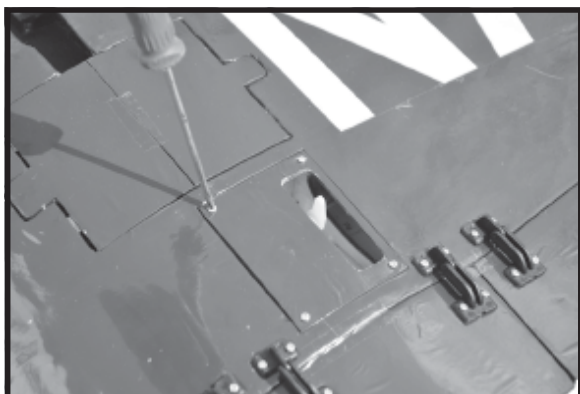
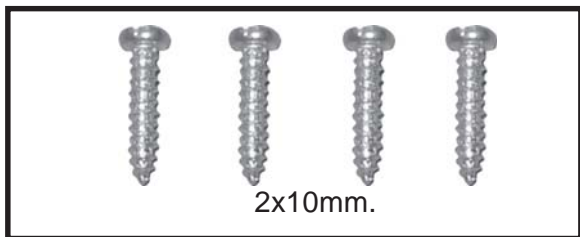
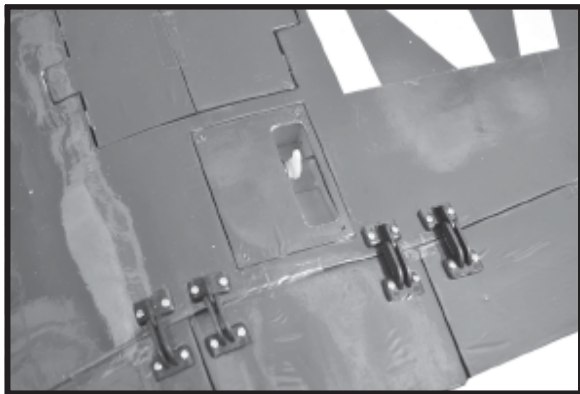
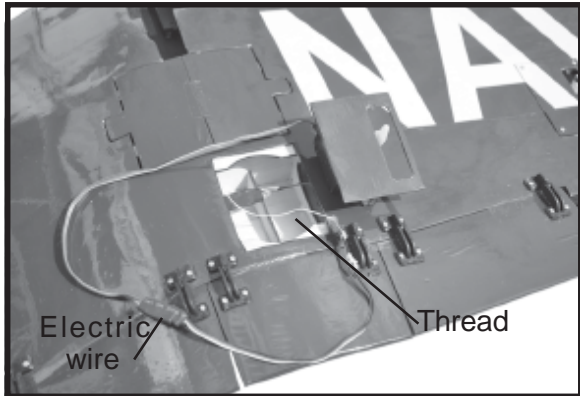

**INSTALLING THE FLAP CONTROL HORN.**

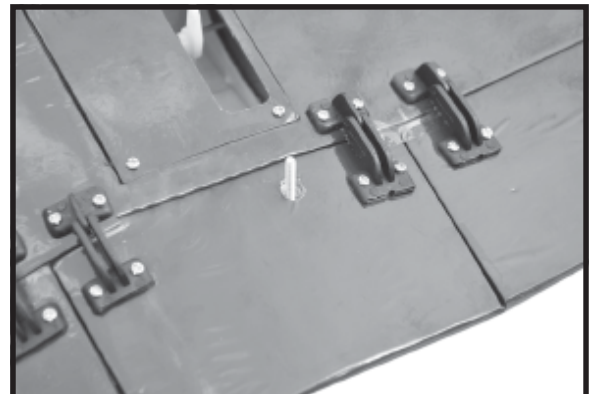
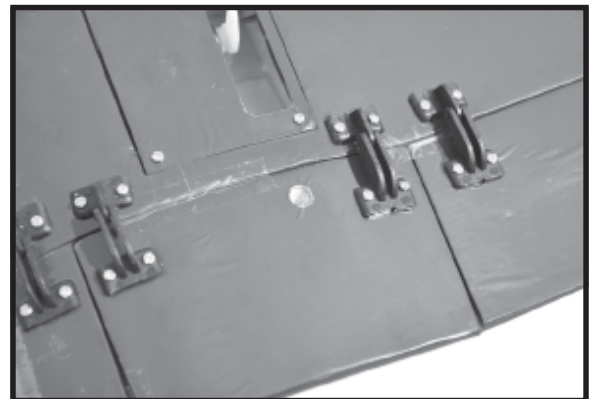
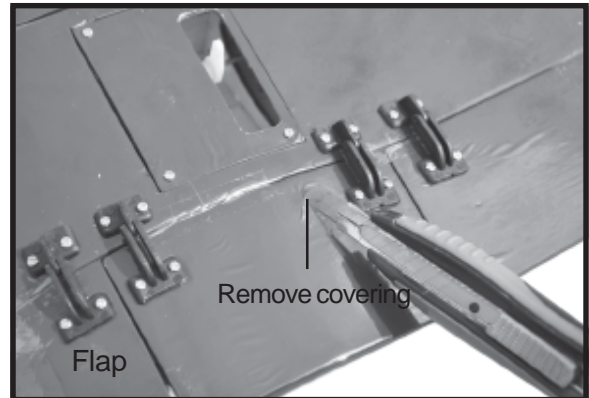
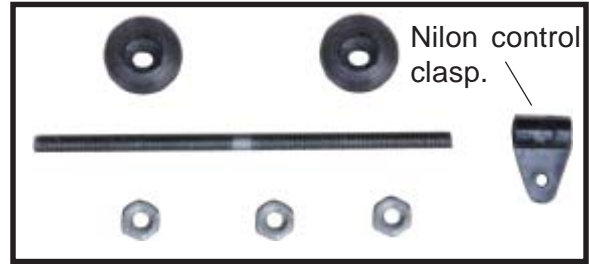

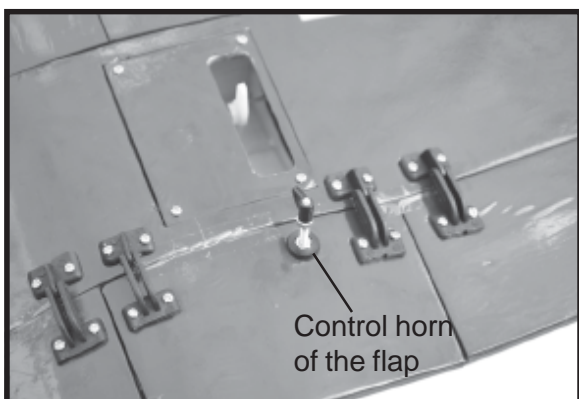
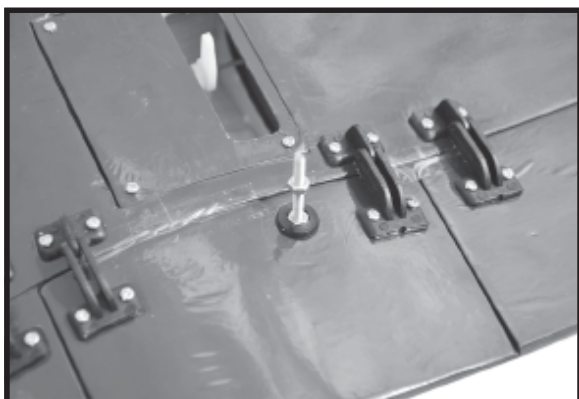
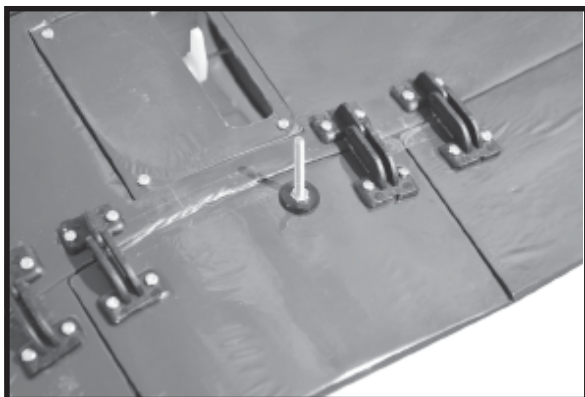
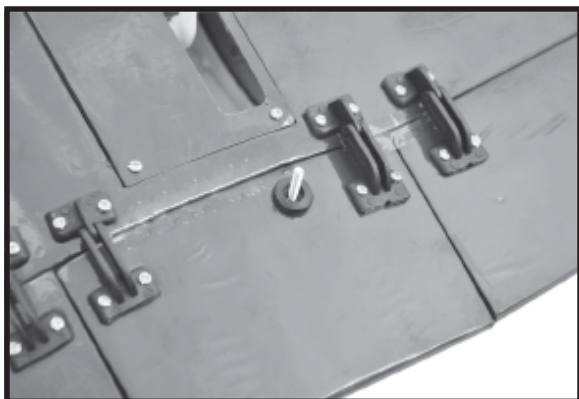

**INSTALLING THE FLAP LINKAGES.**

Installing the aileron linkages as pictures below.

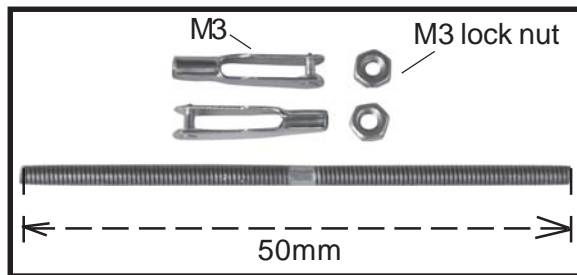

Repeat the procedure for the other wing half.

**INSTALLING AIR RETRACTABLE LANDING GEAR.**

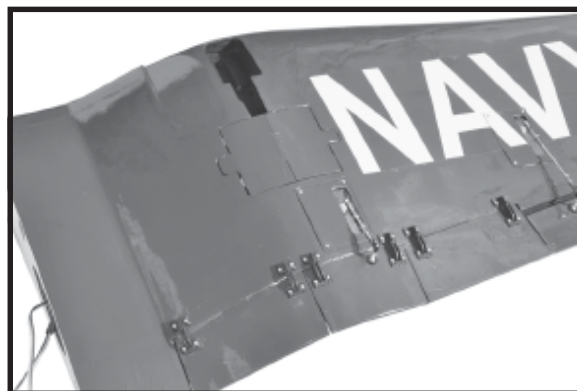

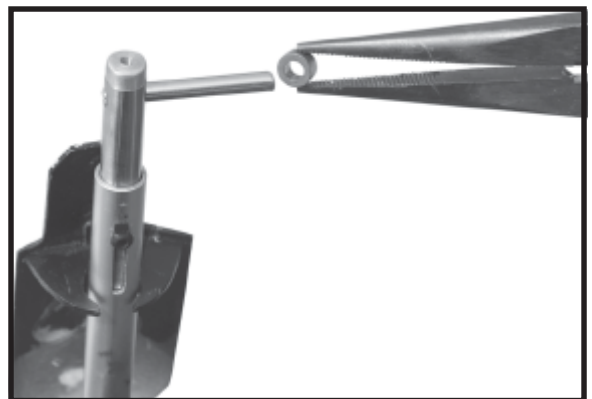
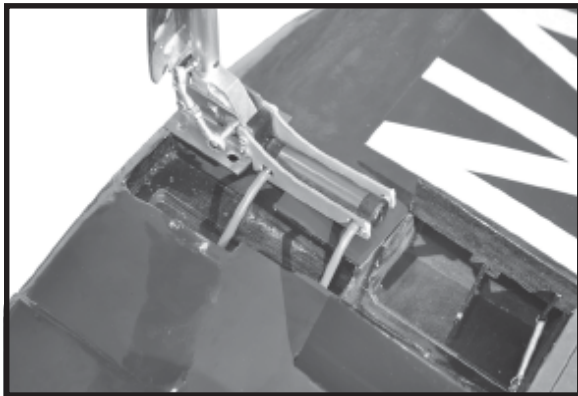
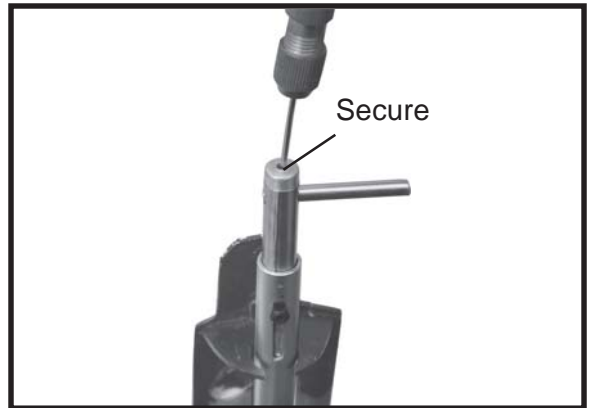
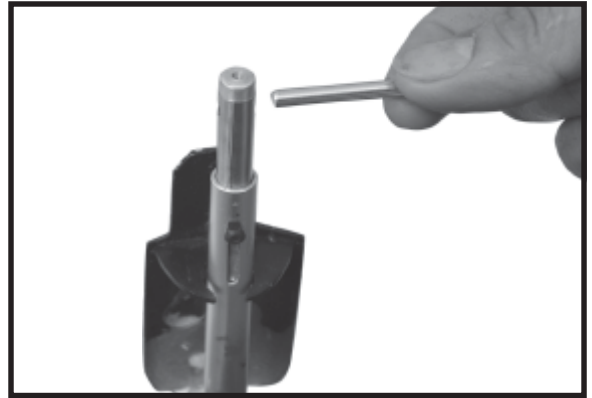



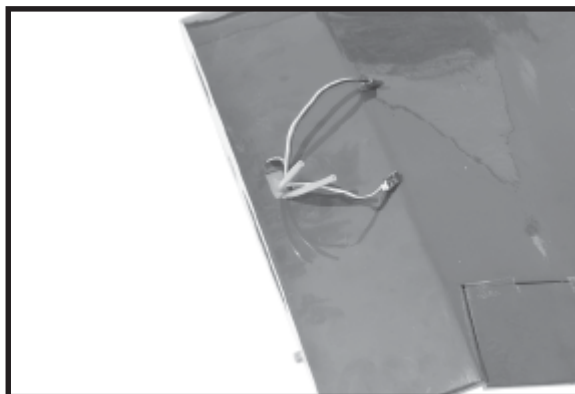
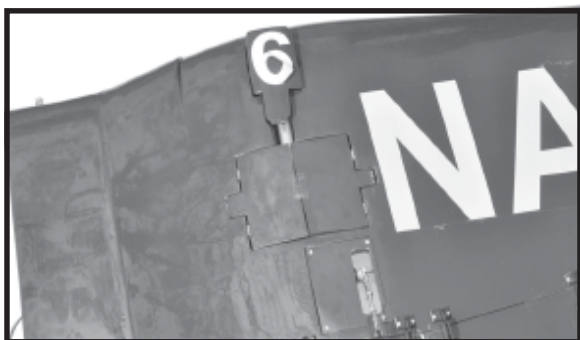
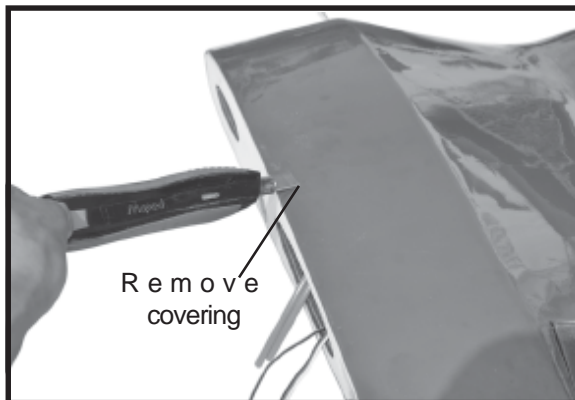
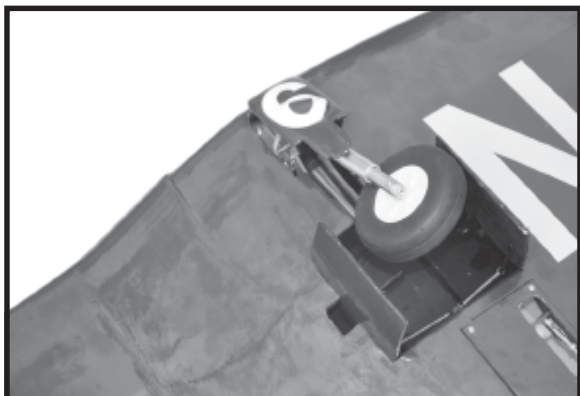
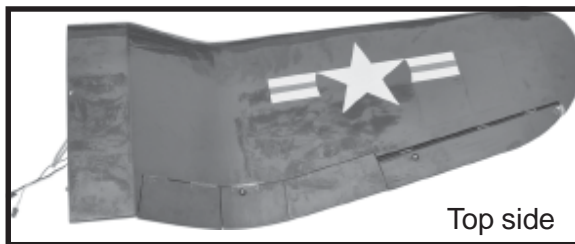
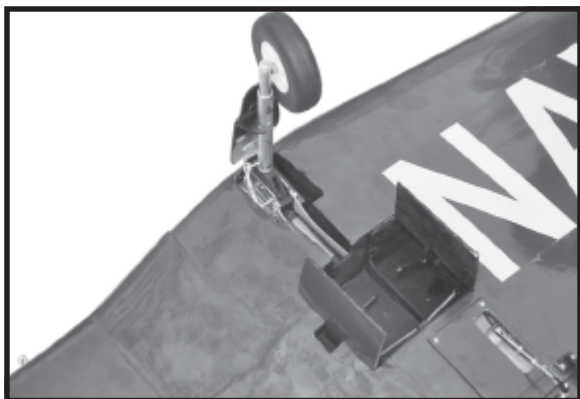

**WING ATTACHMENT.**

☐ Locate the aluminium wing dihedral brace.

\*\*\* Test fit the aluminium tube dihedral brace into each wing haft. The brace should slide in easily. If not, use 220 grit sand around the edges and ends of the brace until it fits properly.

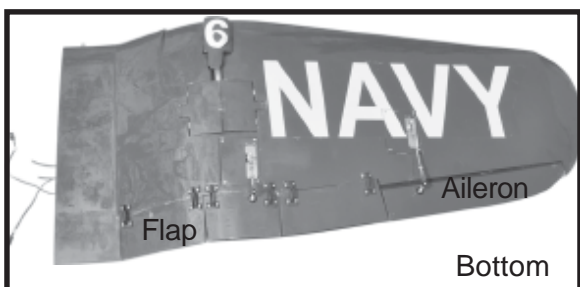



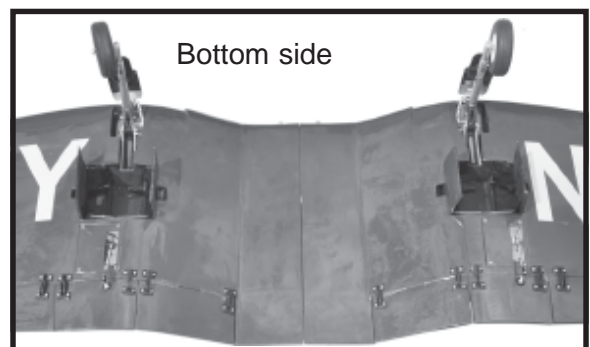
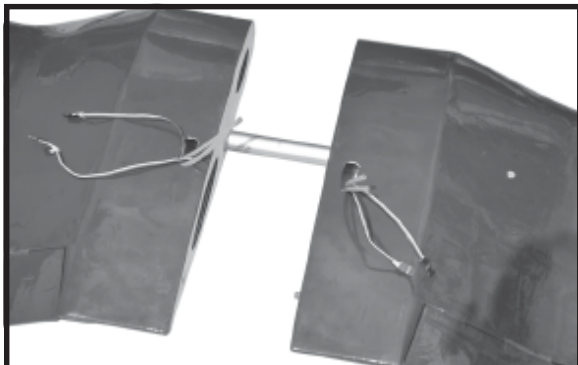
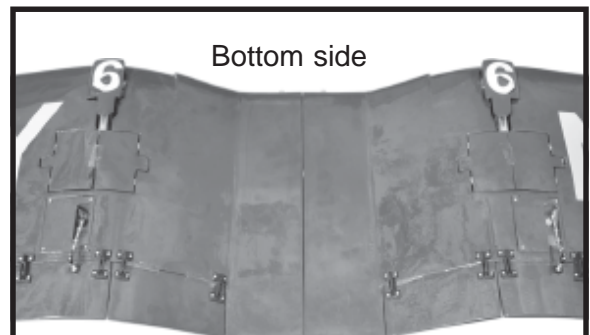
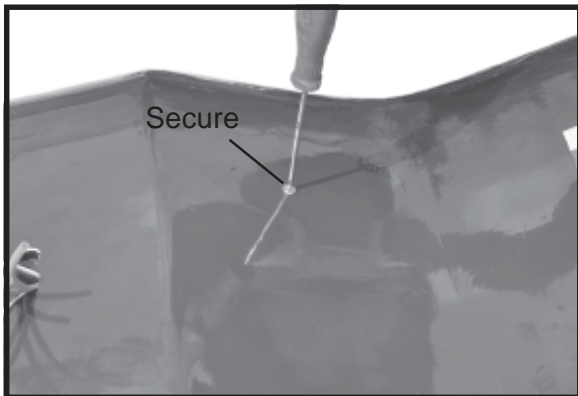
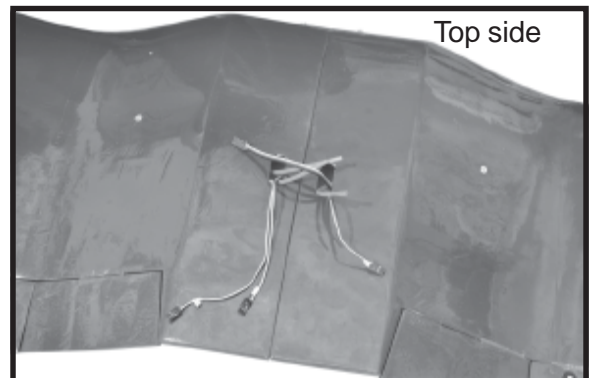
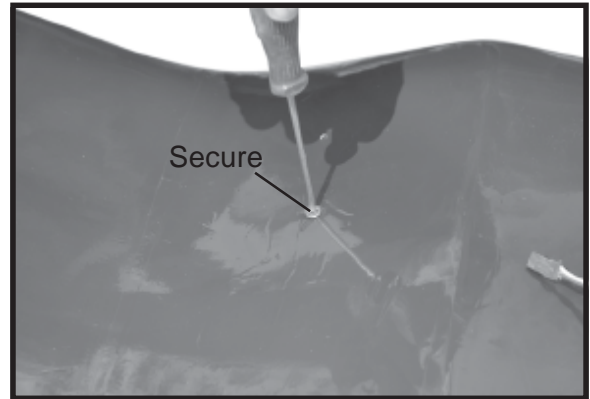
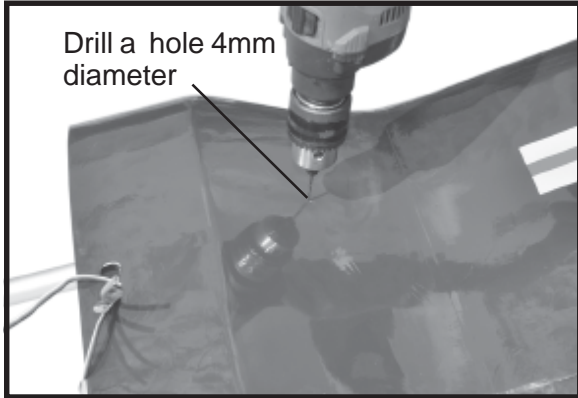
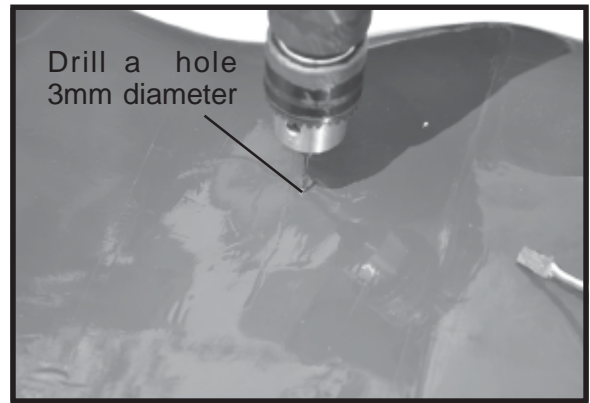
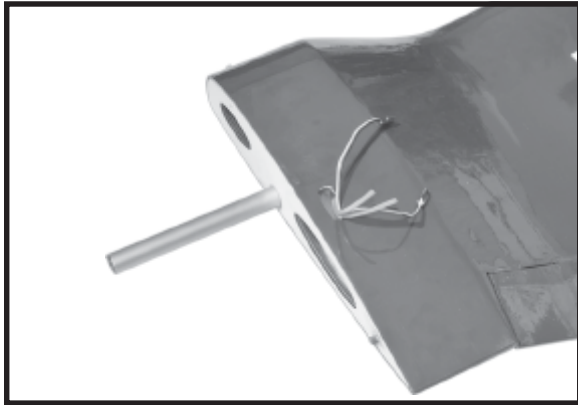

**INSTALLING THE ENGINE MOUNT.**

See pictures below:

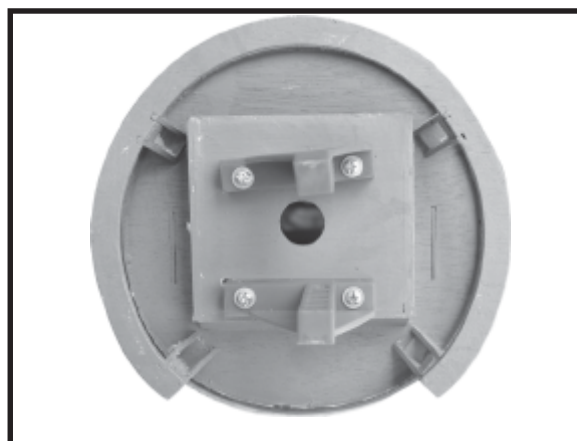
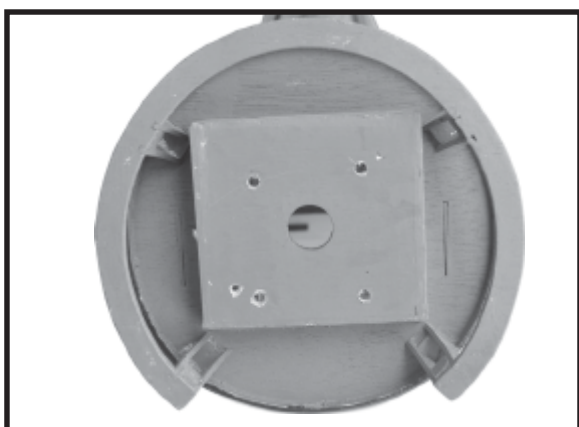
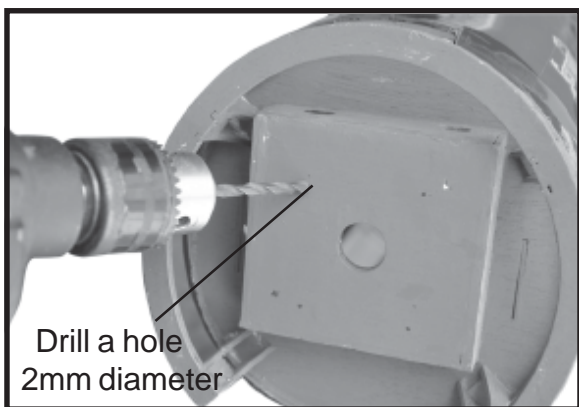
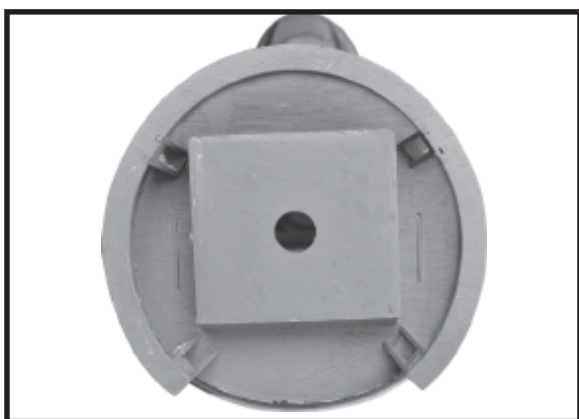
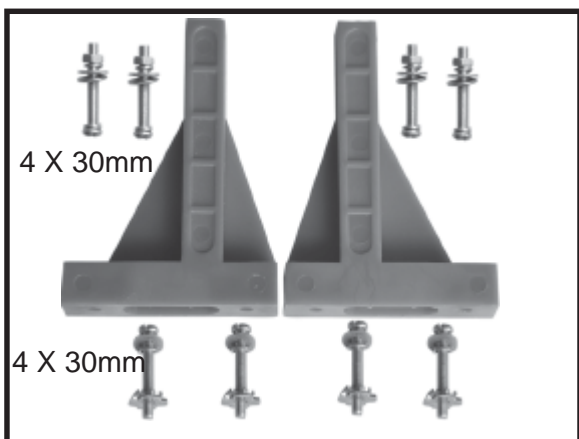

**INSTALLING BATTERY AND FUEL TANK .**

**INSTALLING THE STOPPER ASSEMBLY**

- 1) The stopper has been pre-assembled at the factory.
- 2) Using a modeling knife, cut one length of silicon fuel line (the length of silicon fuel line is calculated by how the weighted clunk should rest about 8mm away from the rear of the tank and move freely inside the tank). Connect one end of the line to the weighted clunk and the other end to the nylon pick up tube in the stopper.
- 3) Carefully bend the second nylon tube up at a 45 degree angle (using a cigarette lighter). This tube will be the vent tube to the muffler.
- 4) Carefully bend the third nylon tube down at a 45 degree angle (using a cigarette lighter). This tube will be vent tube to the fueling valve.

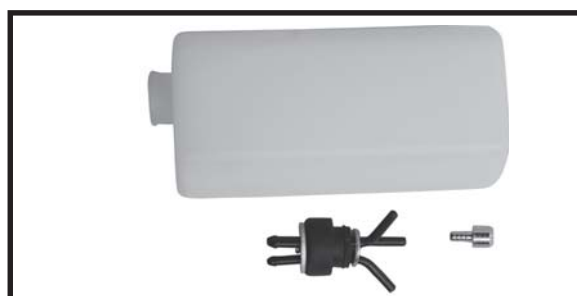

**When the stopper assembly is installed in the tank, the top of the vent tube should rest just below the top surface of the tank. It should not touch the top of the tank.**

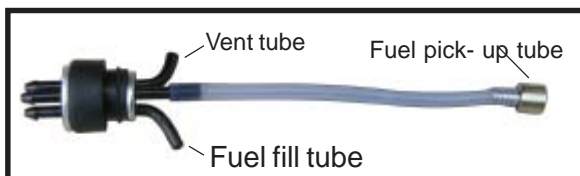
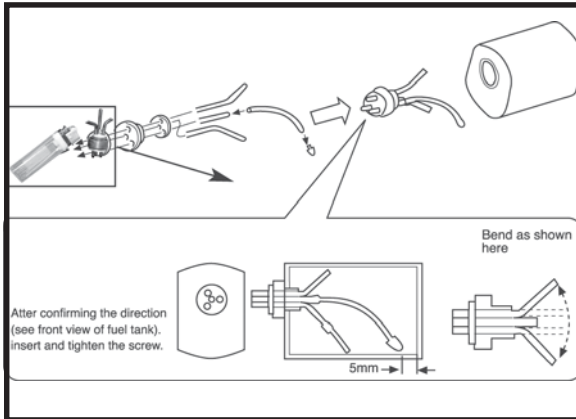

□ 5) Test fit the stopper assembly into the tank. It may be necessary to remove some of the flashing around the tank opening using a modeling knife. If flashing is present, make sure none of it falls into the tank.

□ 6) When satisfied with the alignment of the stopper assembly tighten the 3mm x 20mm machine screw until the rubber stopper expands and seals the tank opening. Do not over tighten the assembly as this could cause the tank to split.

□ 7) Using a modeling knife, cut 3 lengths of fuel line 150mm long. Connect 2 lines to the 2 vent tubes and 1 line to the fuel pickup tube in the stopper.

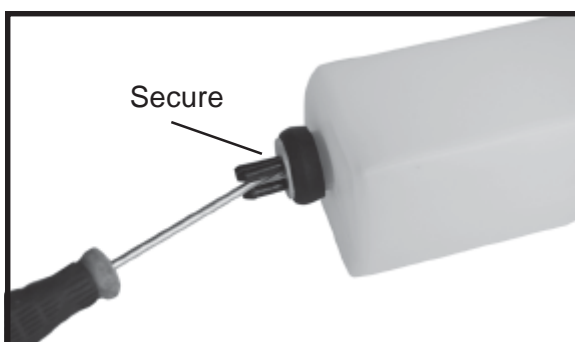
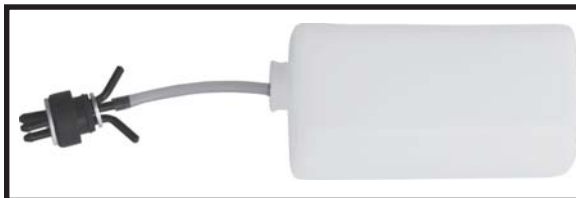

□ 8) Feed three lines through the fuel tank compartment and through the pre-drilled hole in the firewall. Pull the lines out from behind the engine, while guiding the fuel tank into place. Push the fuel tank as far forward as possible, the front of the tank should just about touch the back of the firewall.

Blow through one of the lines to ensure the fuel lines have not become kinked inside the fuel tank compartment. Air should flow through easily.

□ 9) To secure the fuel tank in place, apply a bead of silicon sealer to the forward area of the tank, where it exits the fuselage behind the engine mounting box and to the rear of the tank at the forward bulkhead.

**Do not secure the tank into place permanently until after balancing the airplane. You may need to remove the tank to mount the battery in the fuel tank compartment.**

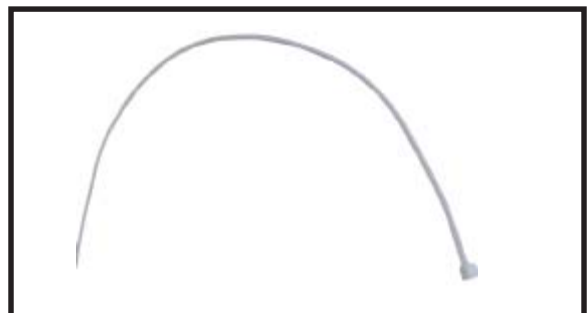
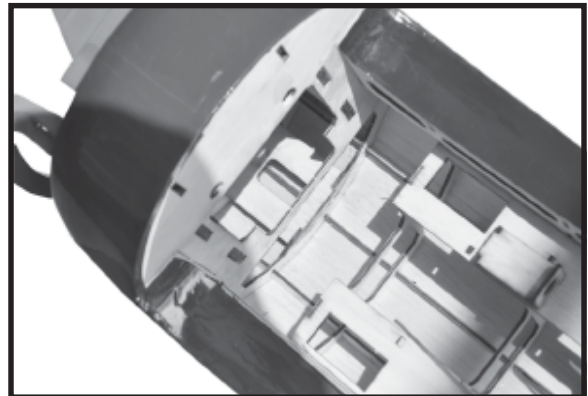



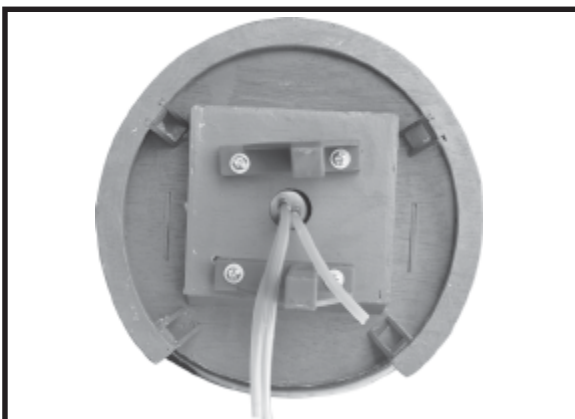
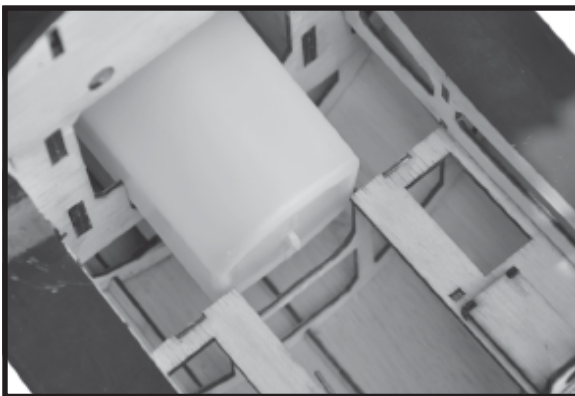
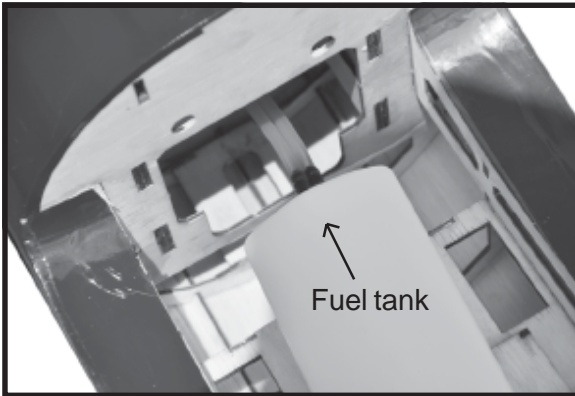
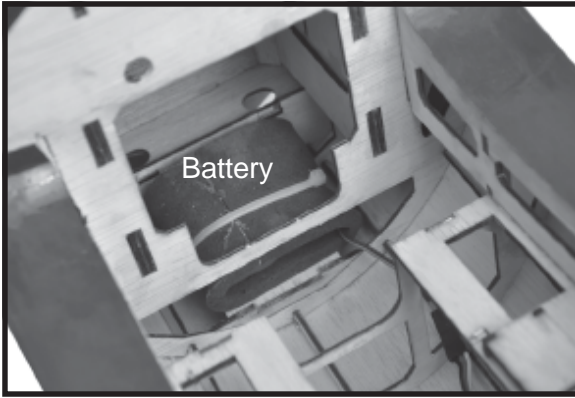

### INSTALLING THE ENGINE.

Locate the long piece of wire used for the throttle pushrod. One end of the wire has been pre-bend in to a "Z" bend at the factory. This "Z" bend should be inserted into the throttle arm of the engine when the engine is fitted onto the engine mount. Fit the engine to the engine mount using the screws provided.

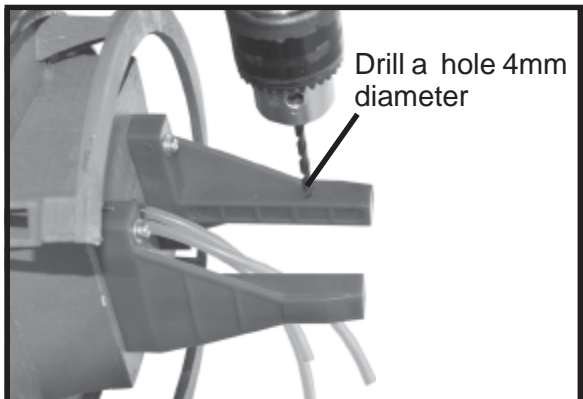
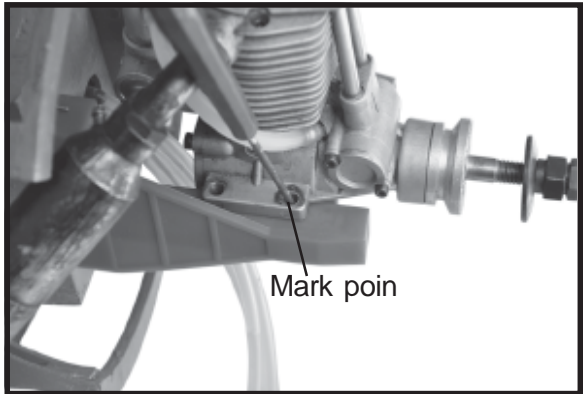
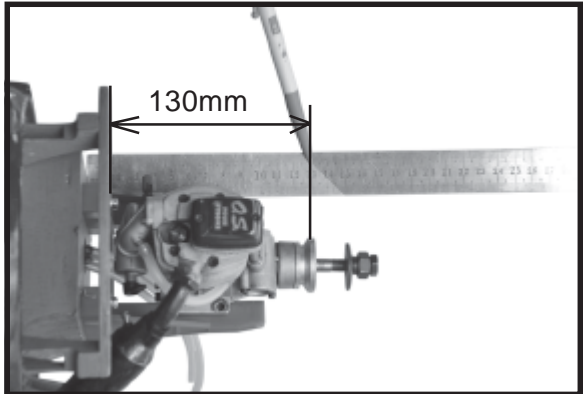



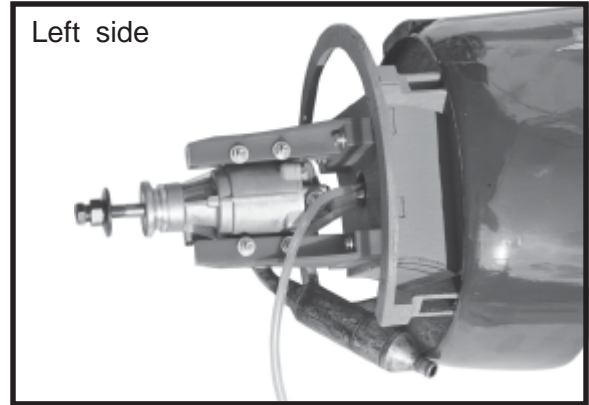
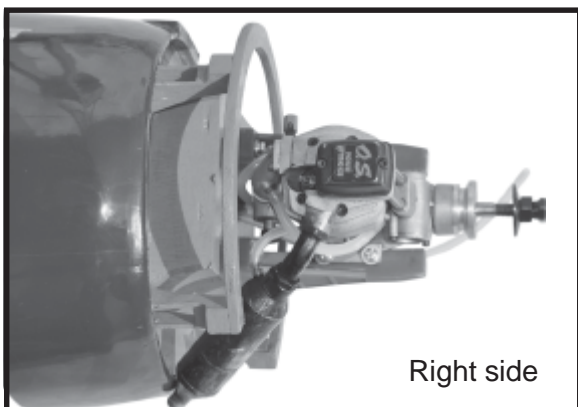
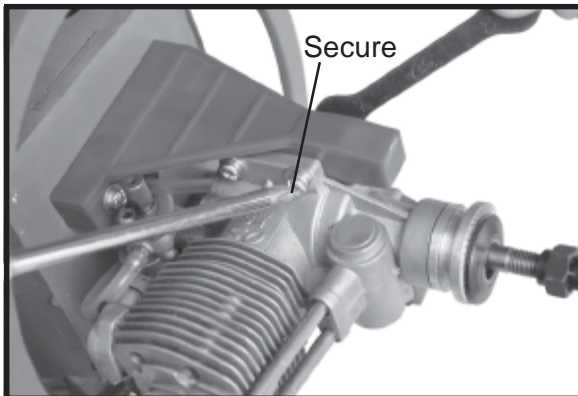
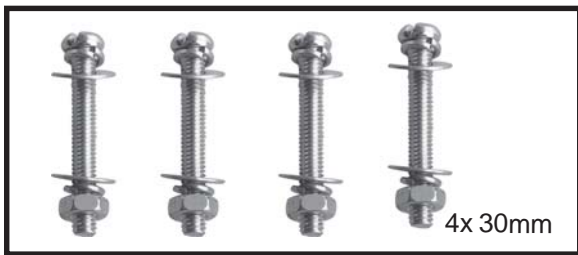
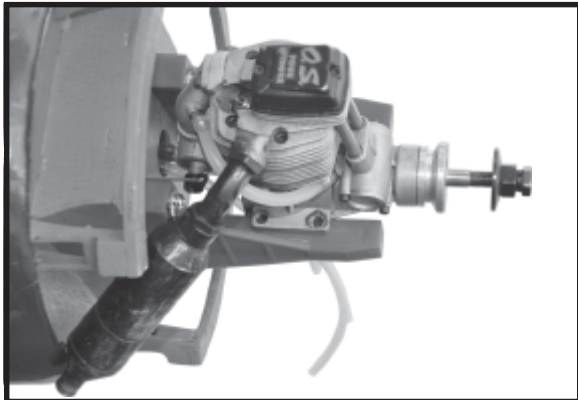
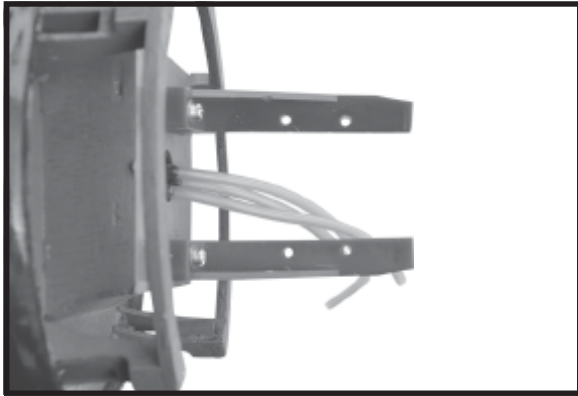

**COWLING.**

□ 1) Slide the fiberglass cowl over the engine and line up the back edge of the cowl with the marks you made on the fuselage.

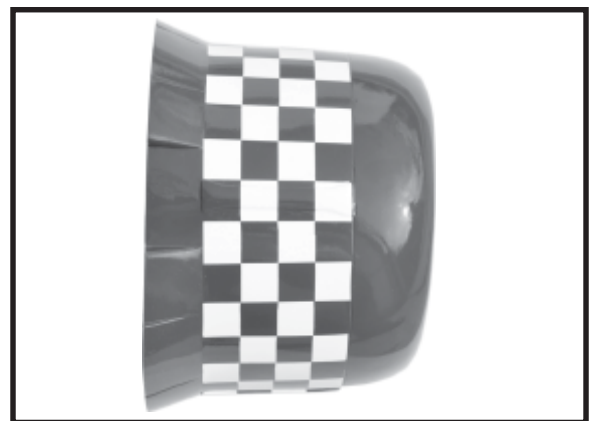

□ 2) While keeping the back edge of the cowl flush with the marks, align the front of the cowl with the crankshaft of the engine. The front of the cowl should be positioned so the crankshaft is in **nearly** the middle of the cowl opening. Hold the cowl firmly in place using pieces of masking tape.

□ 3) Slide the cowl back over the engine and secure it in place using four wood screws. See picture below.

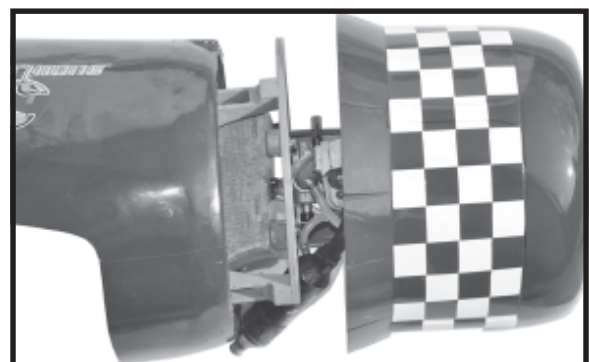

□ 4) Install the muffler and muffler extension onto the engine and make the cutout in the cowl for muffler clearance. Connect the fuel and pressure lines to the carburetor, muffler and fuel filler valve.

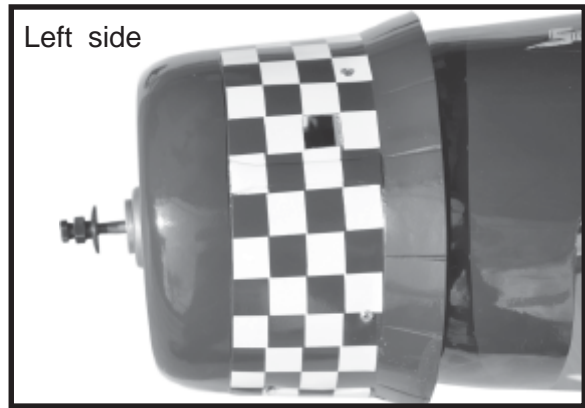
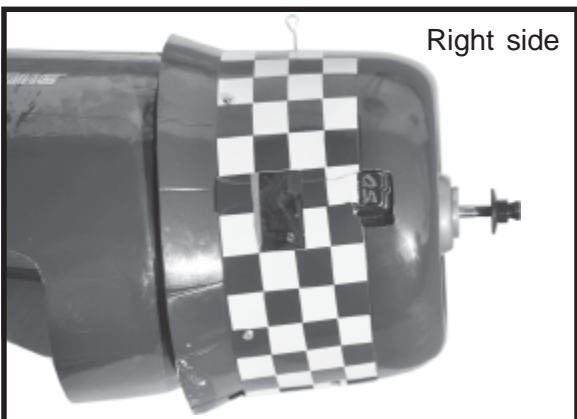
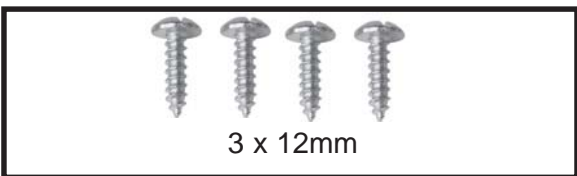
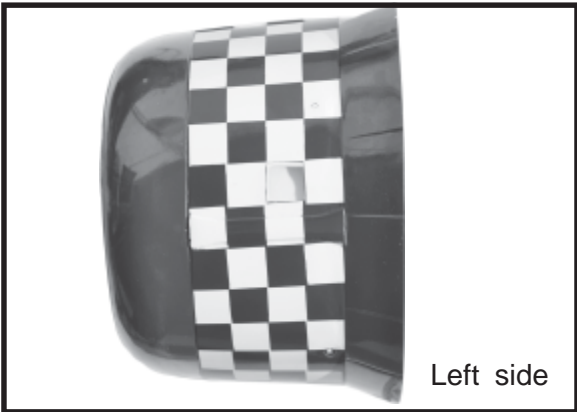
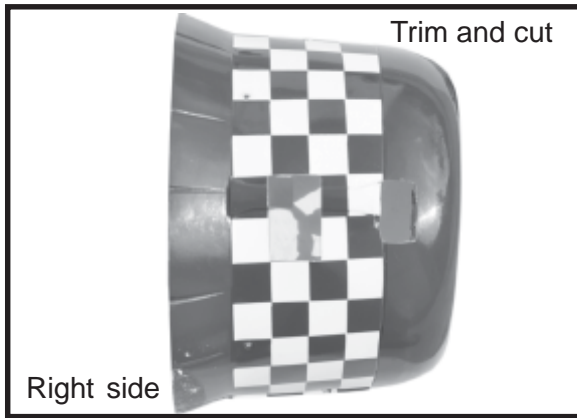

**INSTALLING THE THROTTLE PUSHROD**

□ 1. Install one adjustable metal connector through the third hole out from the center of one servo arm, enlarge the hole in the servo arm using a 2mm drill bit to accommodate the servo connector. Remove the excess material from the arm.



*After installing the adjustable metal connector apply a small drop of thin C/A to the bottom nut. This will prevent the connector from loosening during flight.*

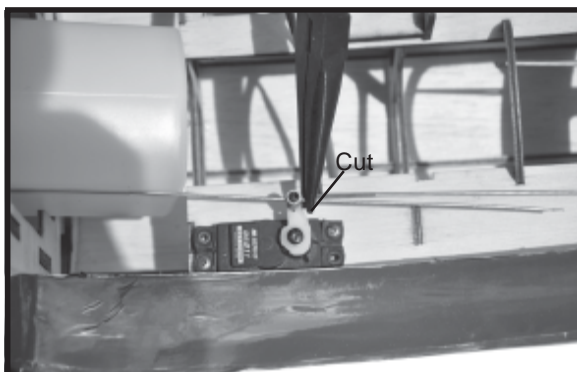
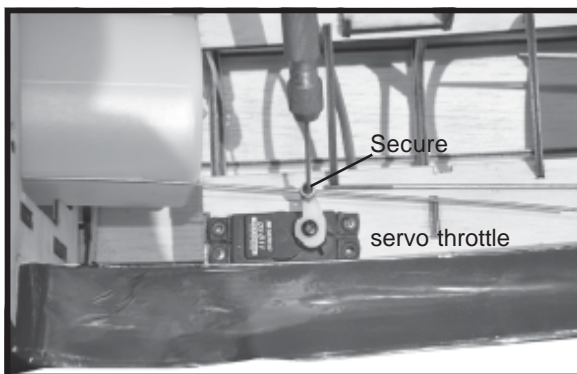

**ELEVATOR INSTALLATION.**

**SERVO INSTALLATION.**

- 1. Install the rubber grommets and brass collets into the elevator servo. Test fit the servo into the servo tray.
- 2. Mount the servo to the tray using the mounting screws provided with your radio system.

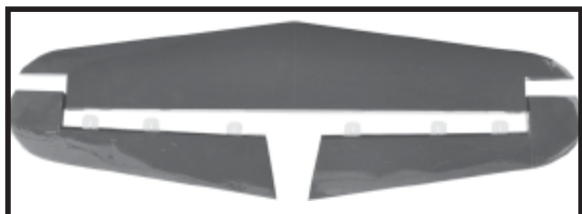
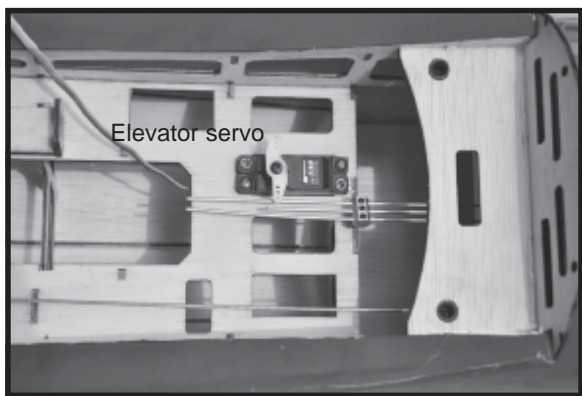
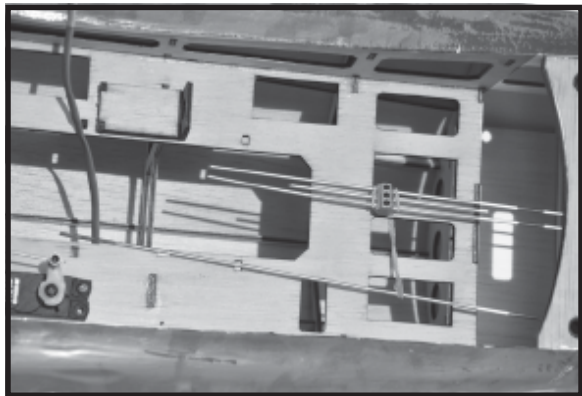

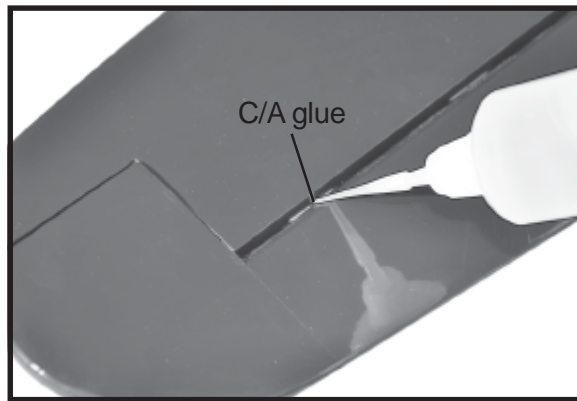
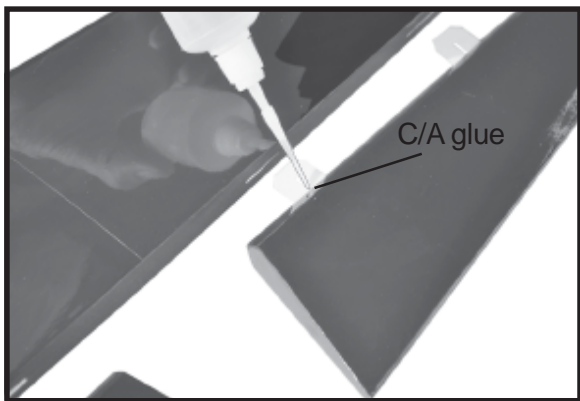
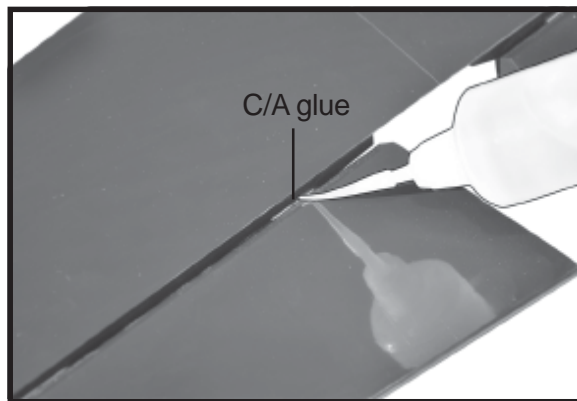
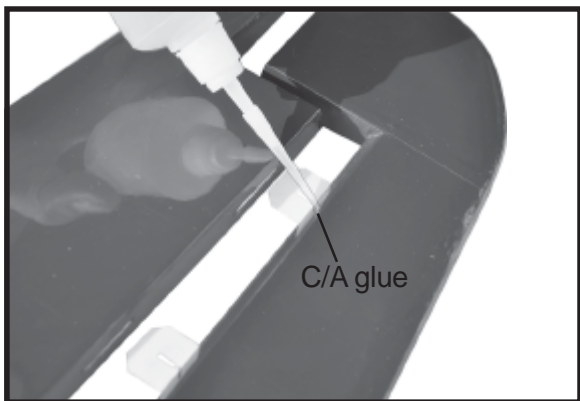

□ 1. Draw a center line onto the horizontal stabilizer. Then slide the horizontal into the fuselage.

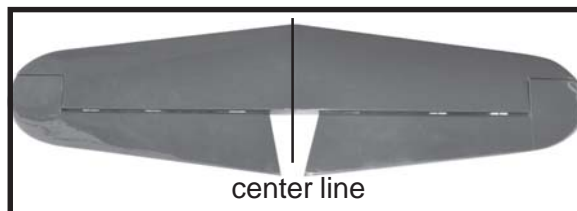
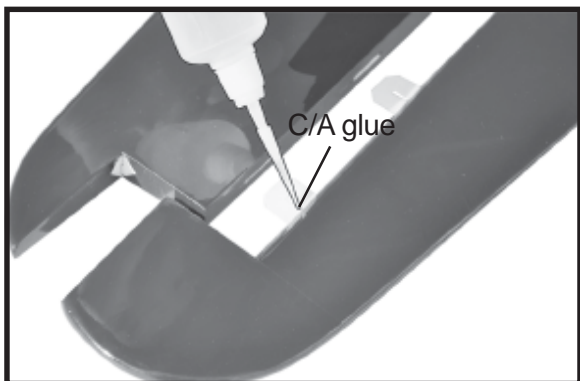

□ 2 Using a modeling knife, cut away the covering from the fuselage for the stabilizer and remove it.

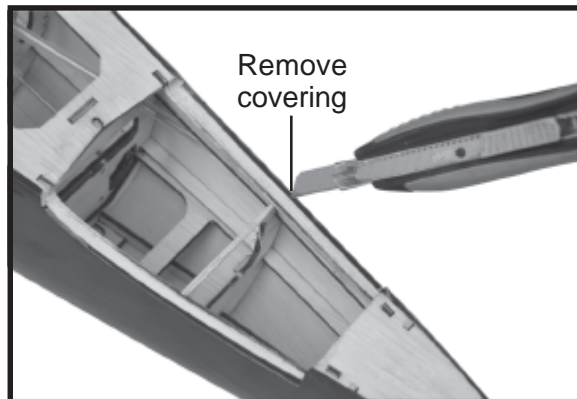
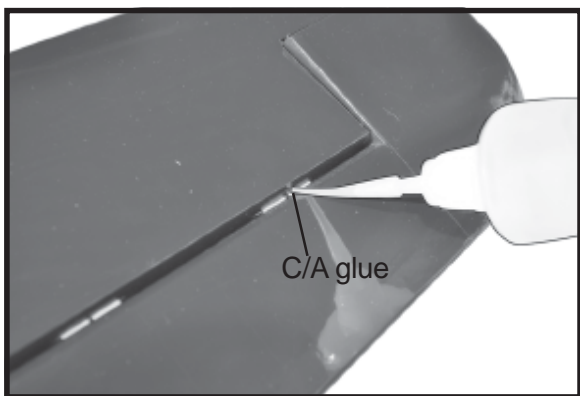

□ 3. Mark the shape of the vertical on the left and right sides onto the horizontal stabilizer using a left-tip pen.



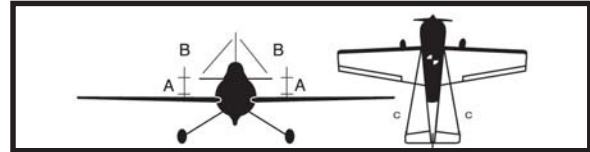
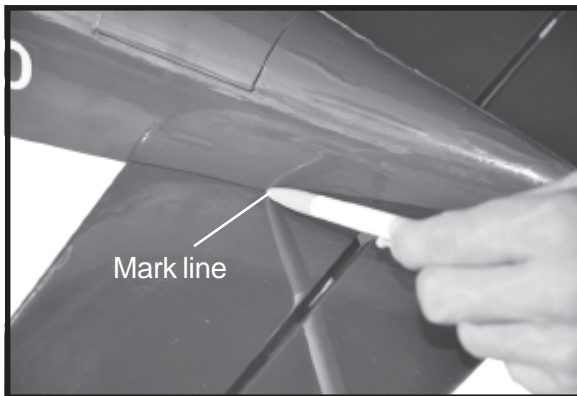
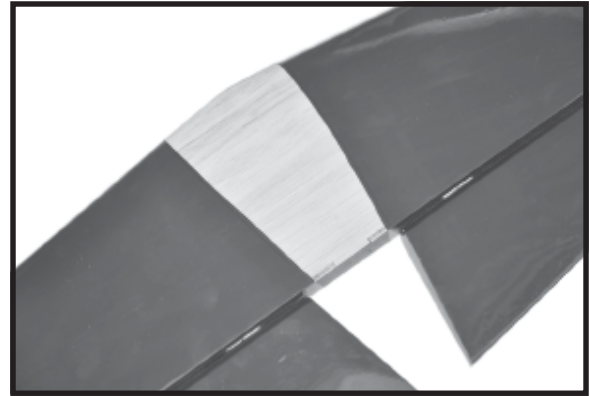
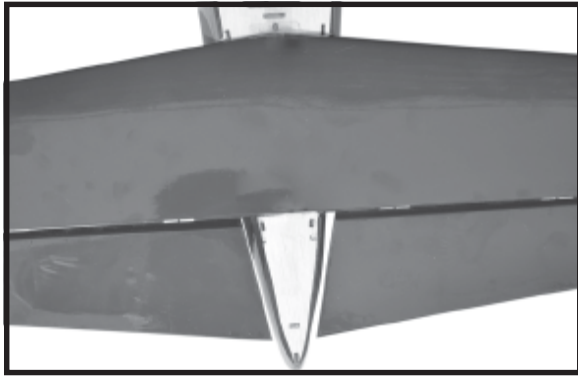

Check to make sure the wing and stabilizer are parallel. If they are not, lightly sand the opening in the fuselage for the stabilizer until the stabilizer is parallel to the wing.

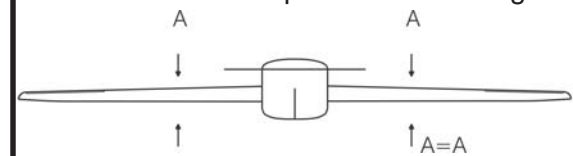

- 4. Remove the stabilizer. Using the lines you just drew as a guide, carefully remove the covering from between them using a modeling knife.

**When cutting through the covering to remove it, cut with only enough pressure to only cut through the covering it's self. Cutting into the balsa structure may weaken it. This could lead to possible failure during flight.**

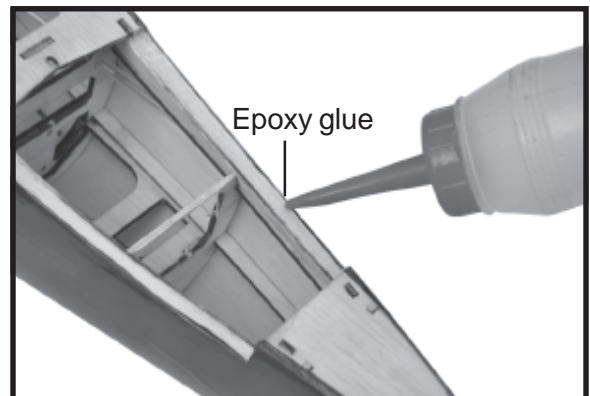

- 5. When you are sure that everything is aligned correctly, mix up a generous amount of 30 minute epoxy. Apply a thin layer to the top and bottom of the stabilizer mounting area and to the stabilizer mounting platform sides in the fuselage. Slide the stabilizer in place and re-align. Double check all of your measurements one more time before the epoxy cures. Remove any excess epoxy using a paper towel and rubbing alcohol and hold the stabilizer in place with T-pins or masking tape.

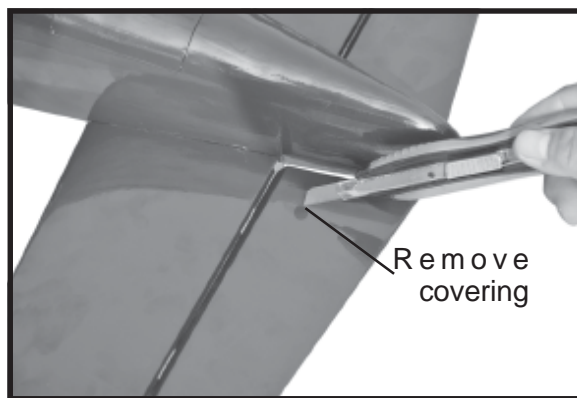
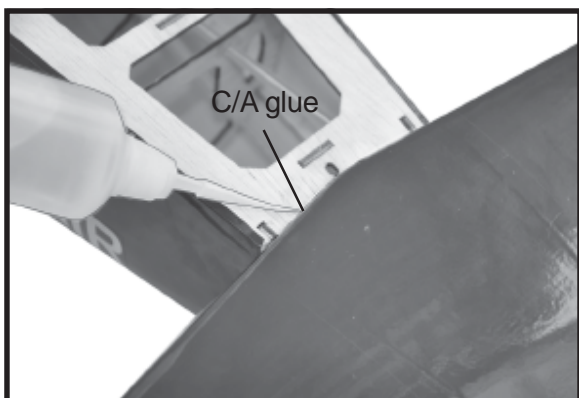

□ 6. After the epoxy has fully cured, remove the masking tape or T-pins used to hold the stabilizer in place and carefully inspect the glue joints. Use more epoxy to fill in any gaps that were not filled previously and clean up the excess using a paper towel and rubbing alcohol.

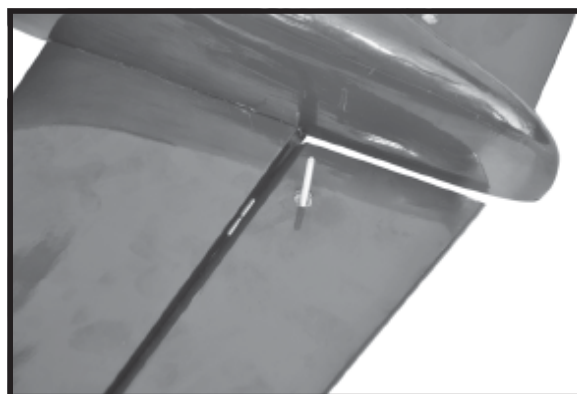
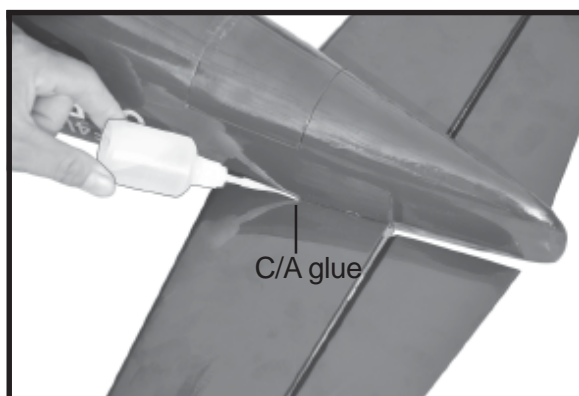
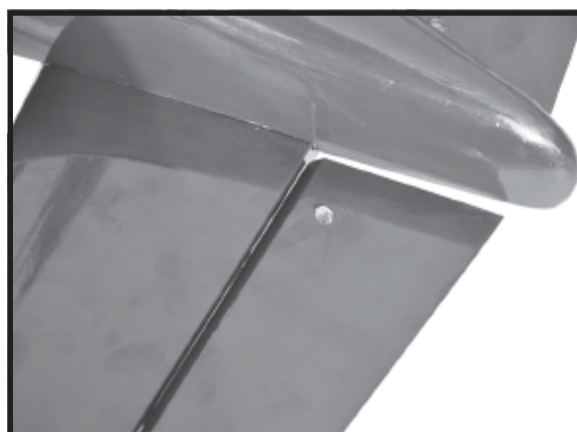
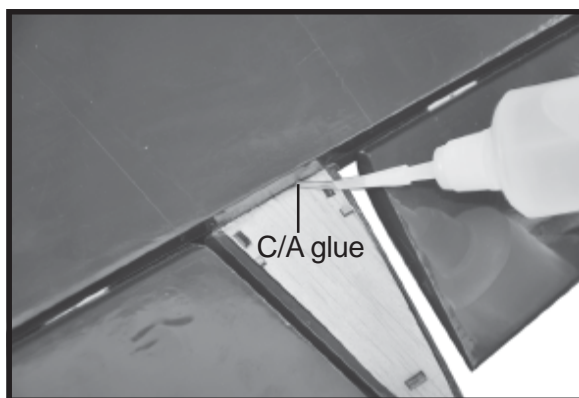

**ELEVATOR CONTROL HORN INSTALLATION.**

Elevator control horn install as same as the way of aileron control horn. Please see pictures below.

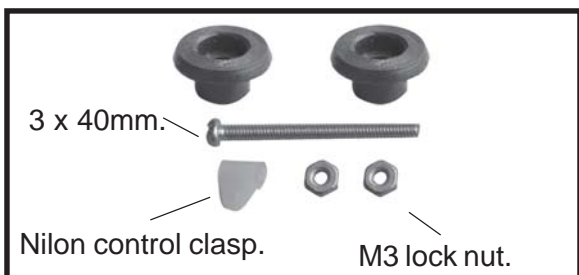

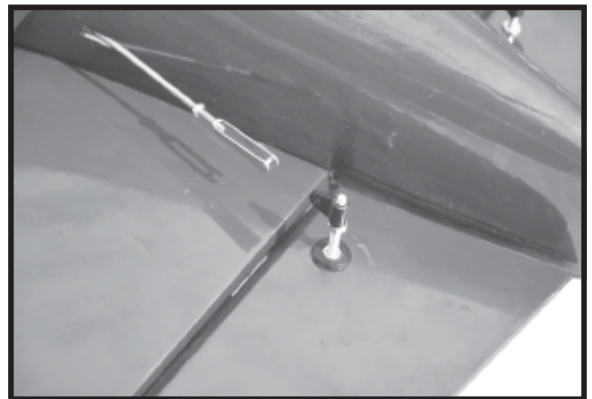
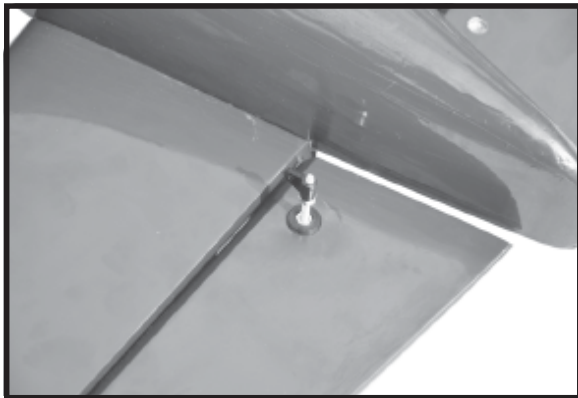
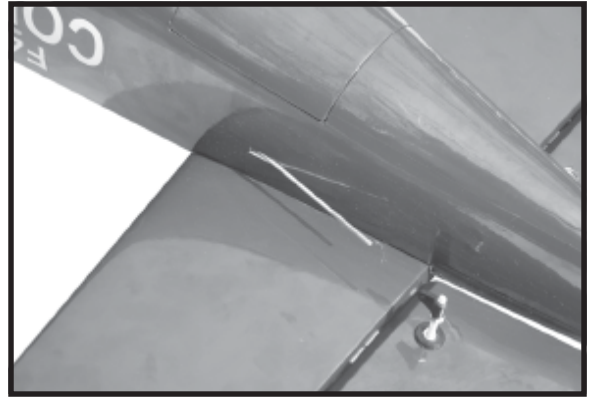

**ELEVATOR PUSHROD INSTALLATION.**

Pushrod install as same as method of pushrod wing. See pictures below:

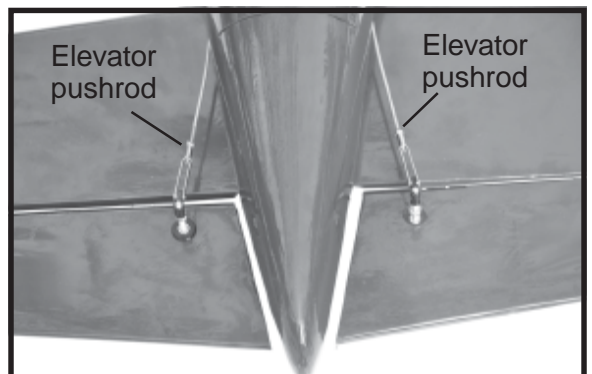
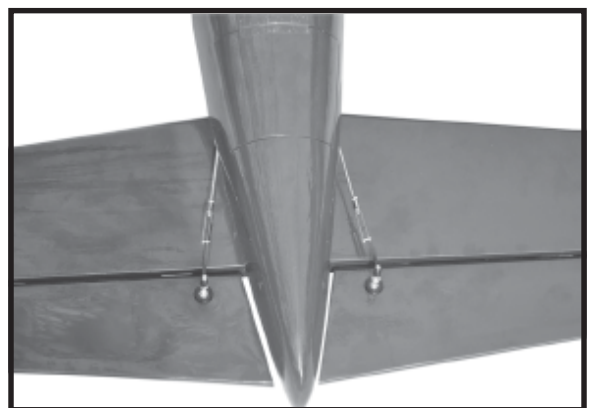



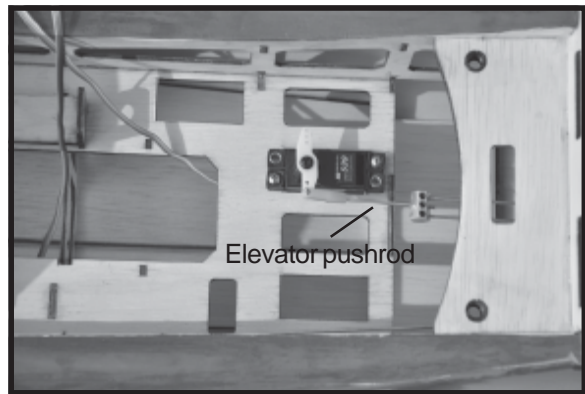
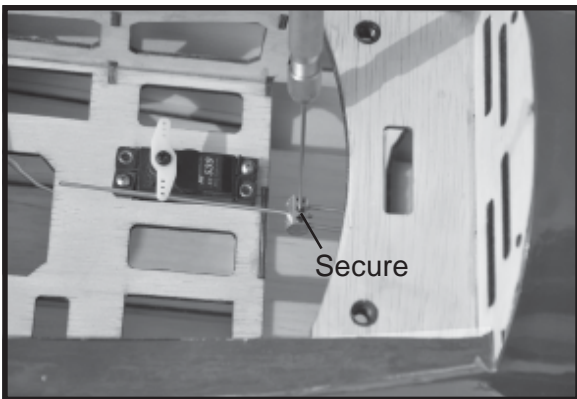
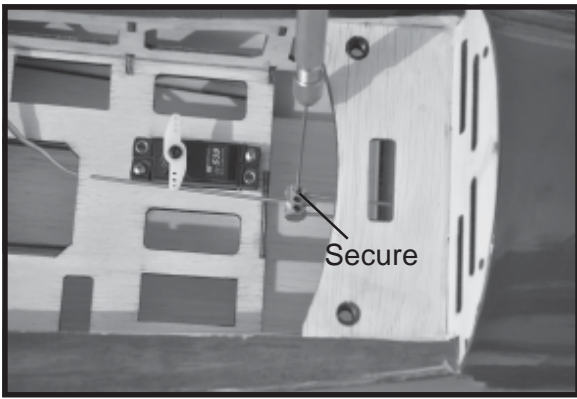

Cut ↗

**VERTICAL INSTALLATION.**

Rudder servo install as same as method of elevator servo. See picture below:

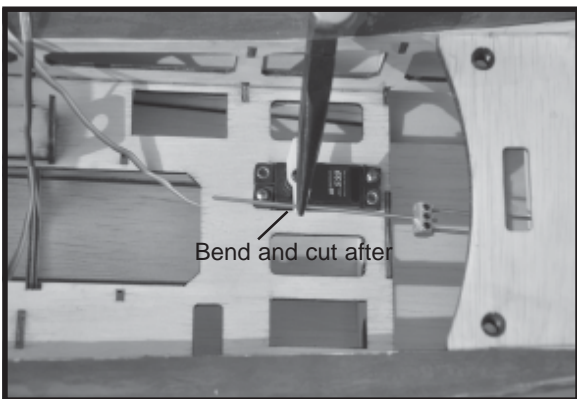



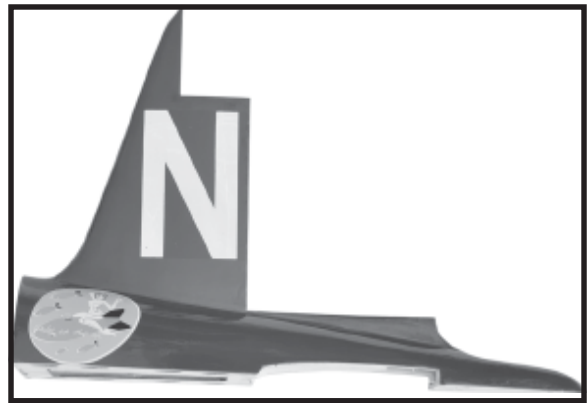

- 1. Put the rudder into the fuselage as same as picture below.

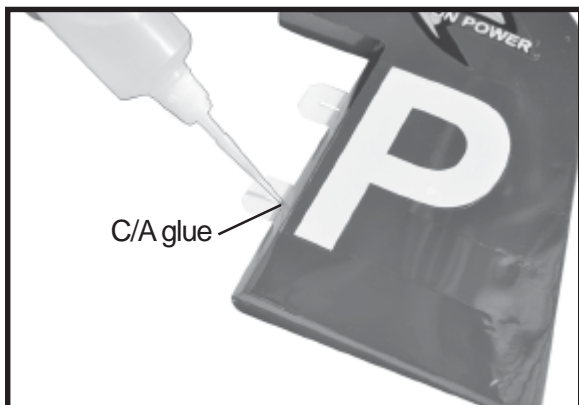
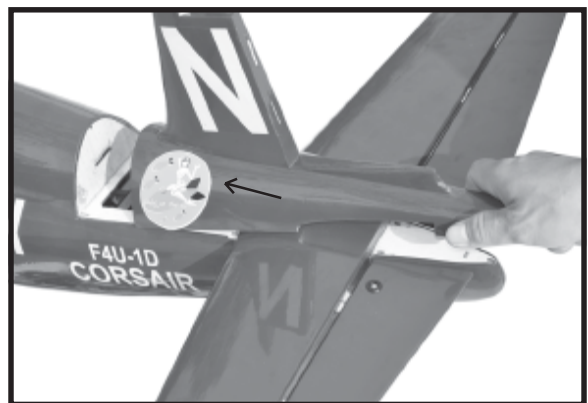
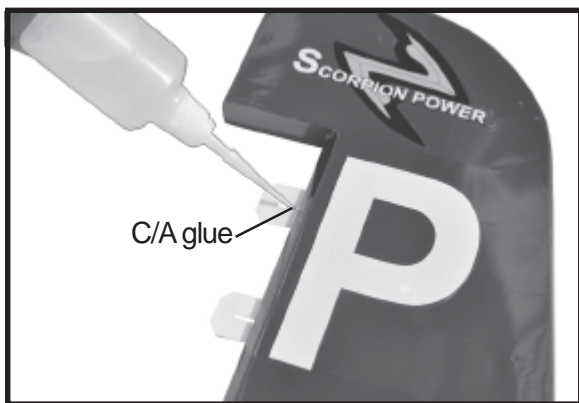

- 2. Mark the shape of the vertical on the left and right side of the rudder using a felt-tip pen.

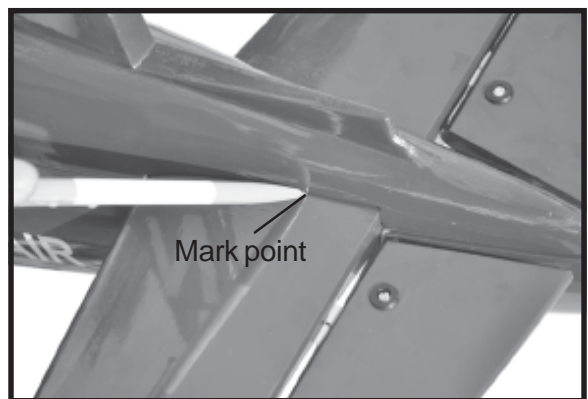

- 3. Now, remove the rudder and using a modeling knife, carefully cut just inside the marked lines and remove the film of the rudder. Just as you did with the horizontal stabilizer, make sure you only press hard enough to cut the film, not the balsa rudder.

- Also carefully remove the covering from the horizontal fin as below the lines which you drew as same picture below.

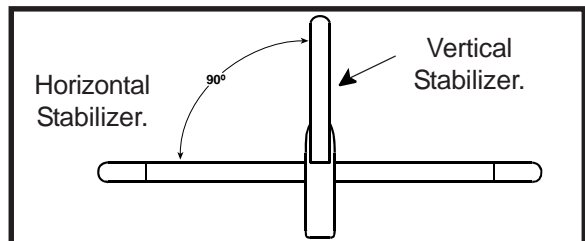
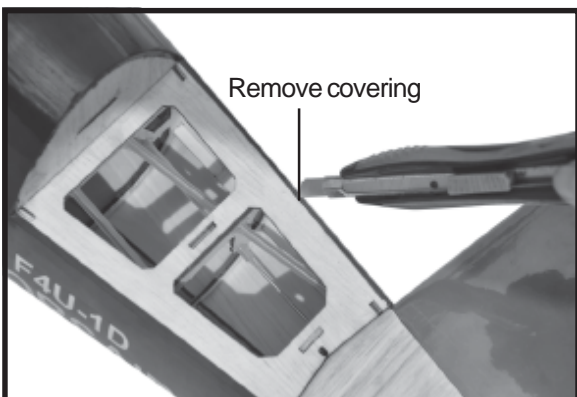
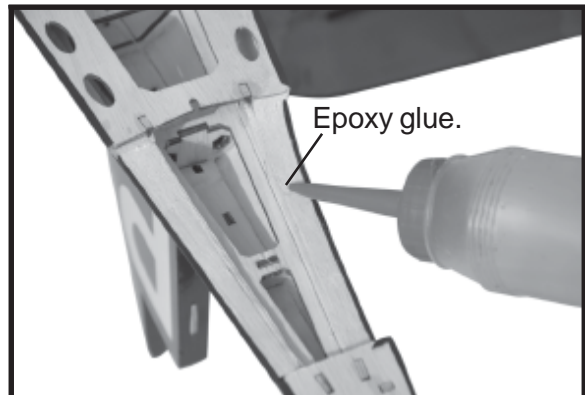
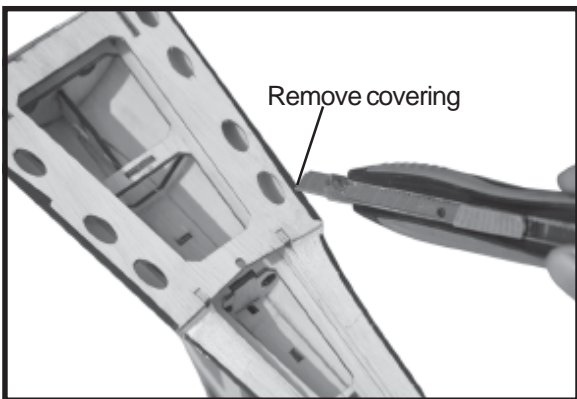
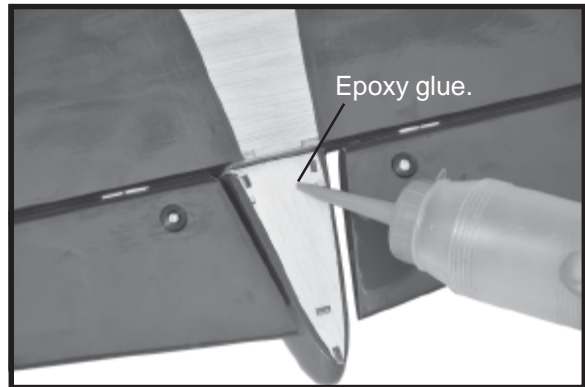
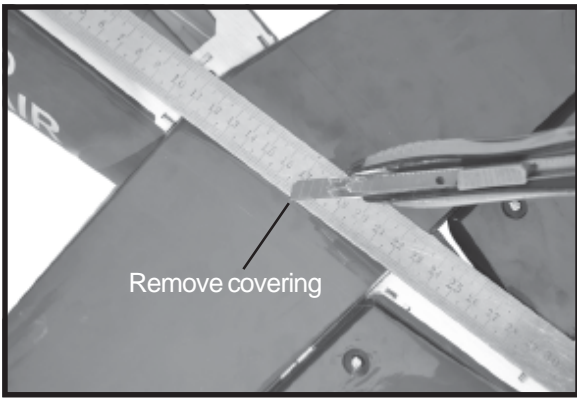

□ 5. Put the vertical stabilizer back in place. Using a triangle, check to ensure that the vertical stabilizer is aligned 90 degree to the horizontal stabilizer.

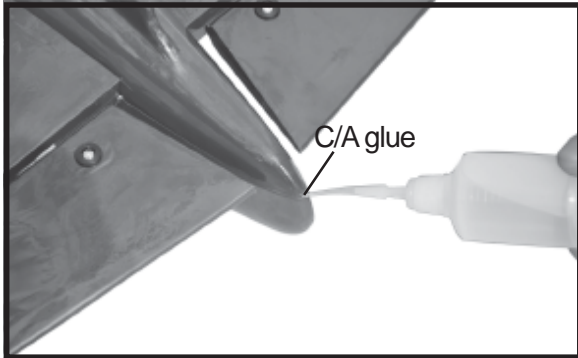
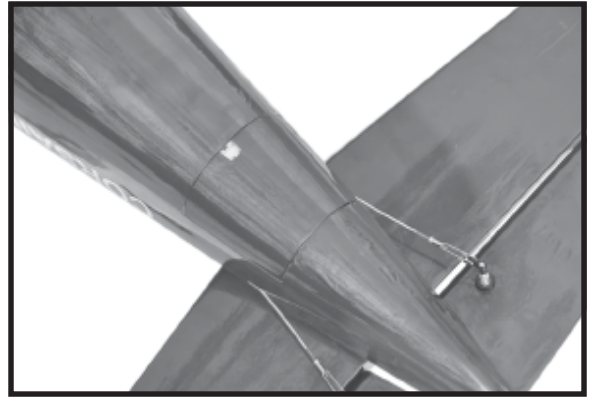
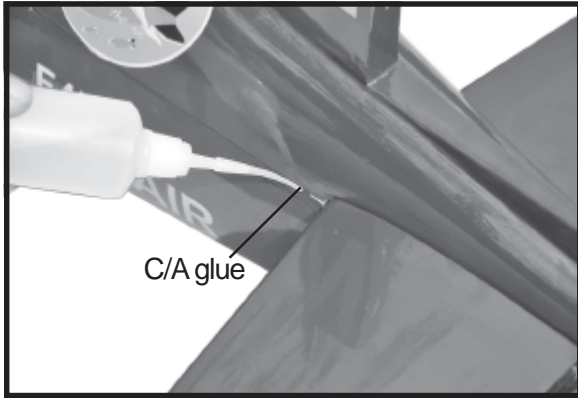

**MOUNTING THE TAIL WHEEL BRACKET.**

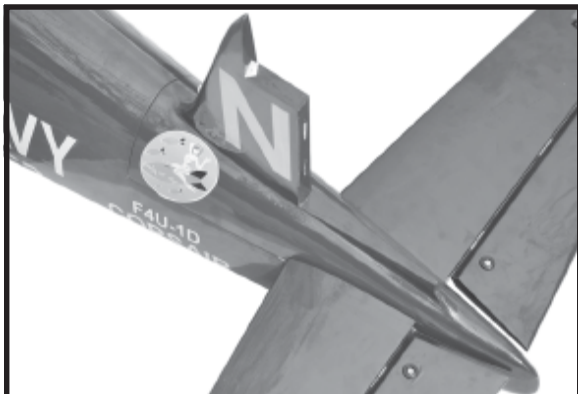
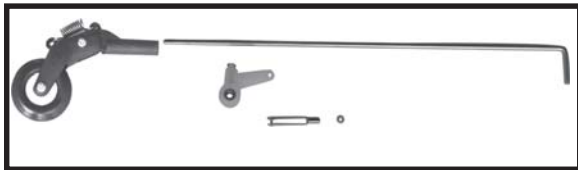



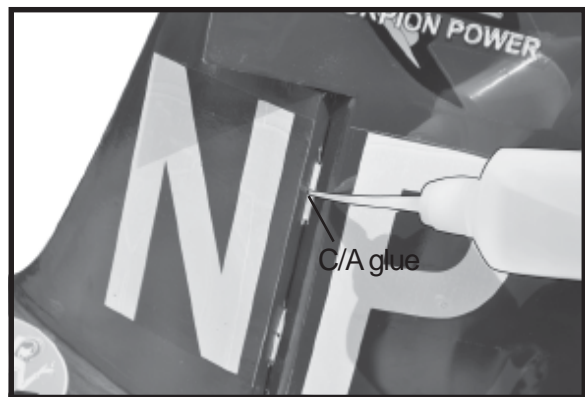
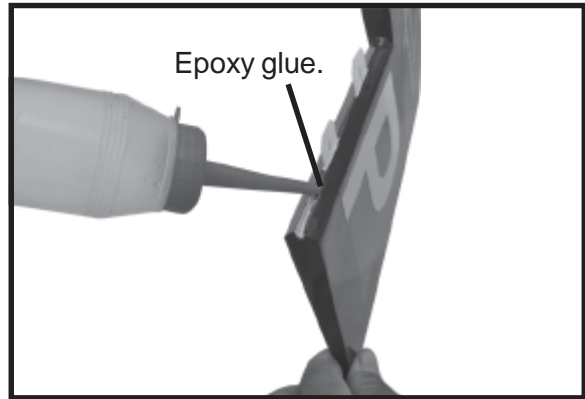
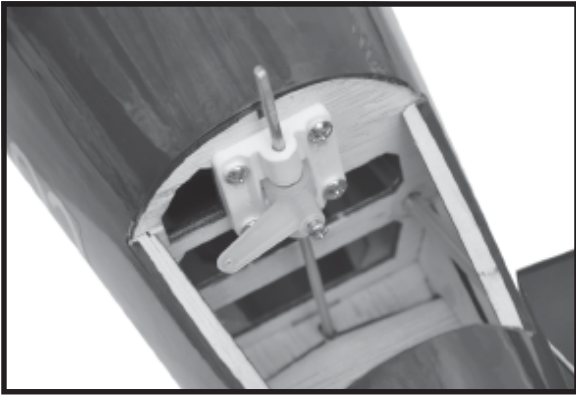



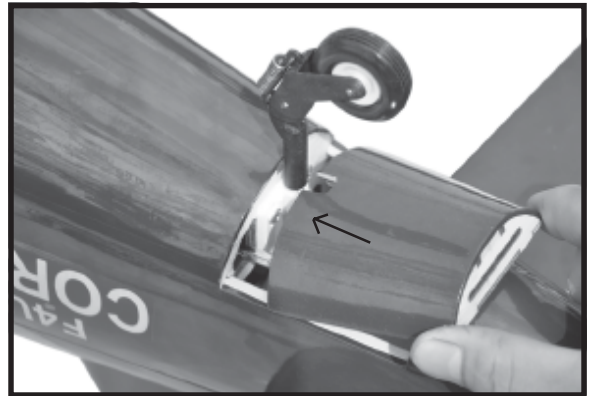
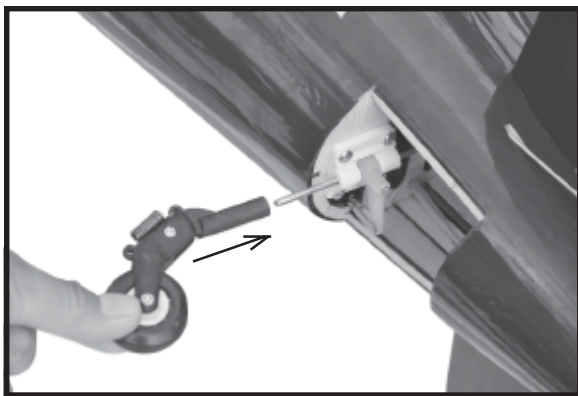
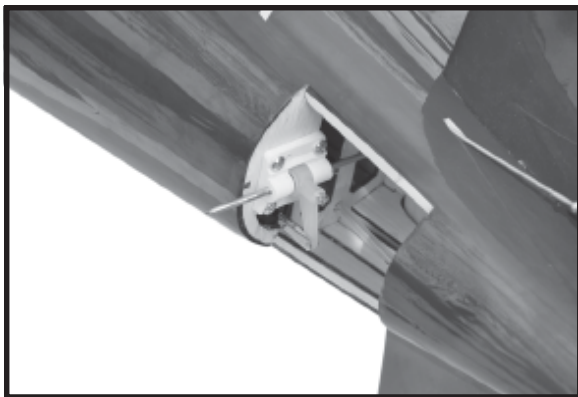
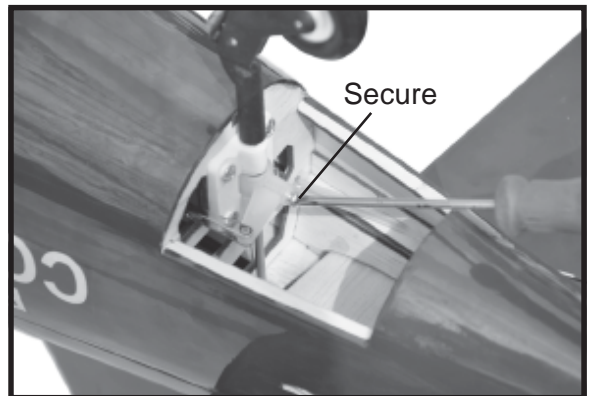
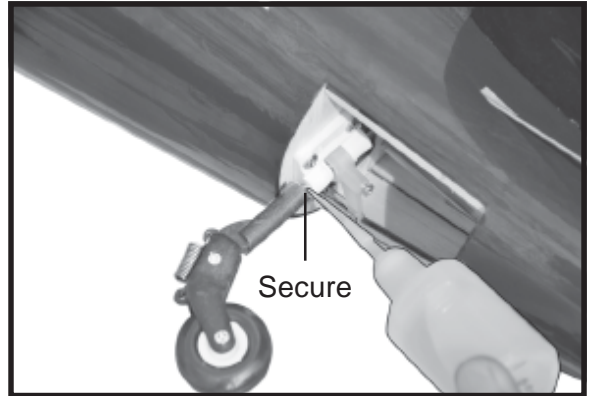

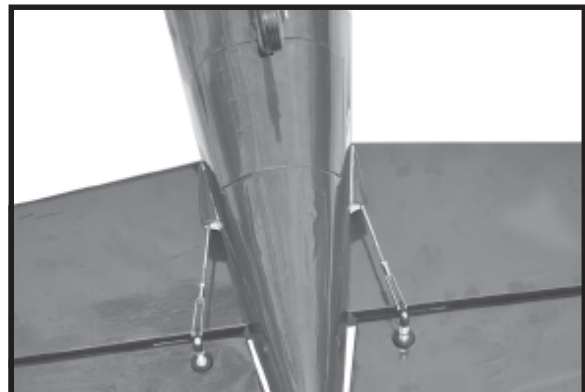
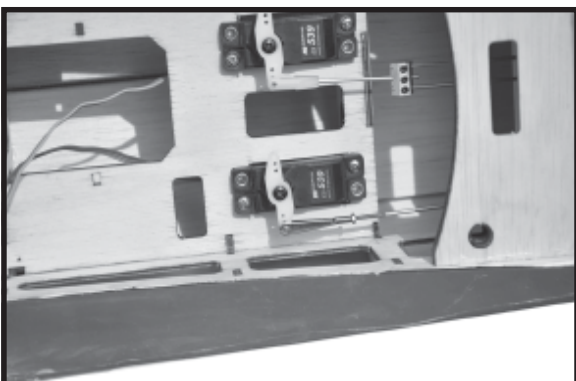
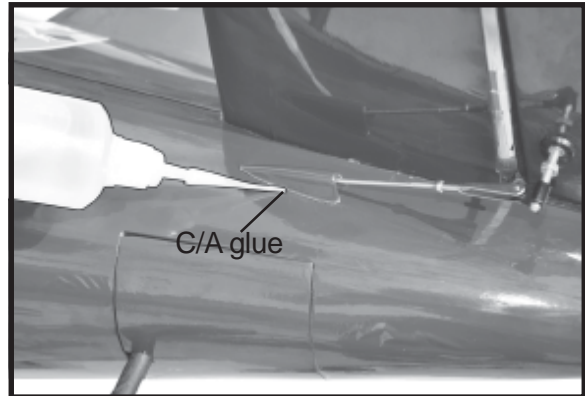
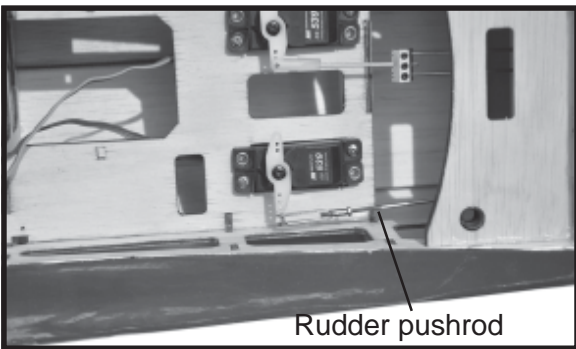
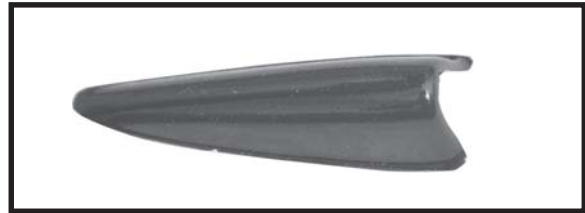
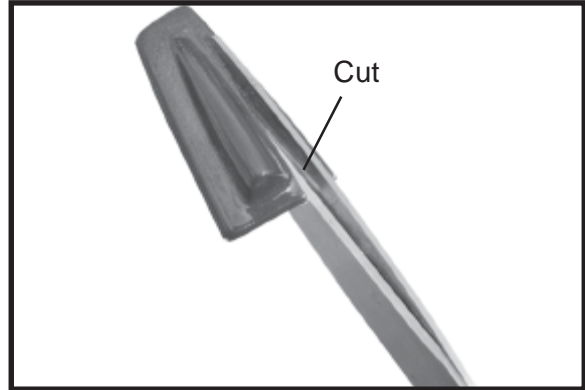

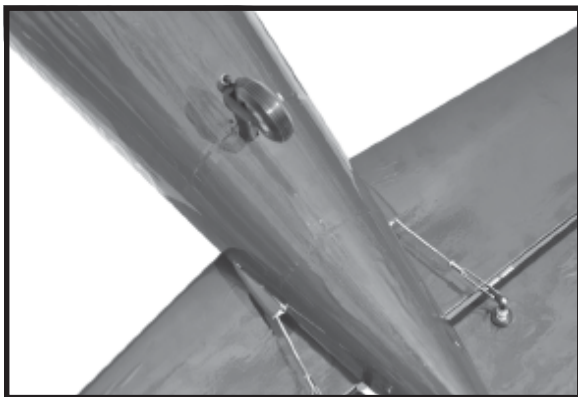
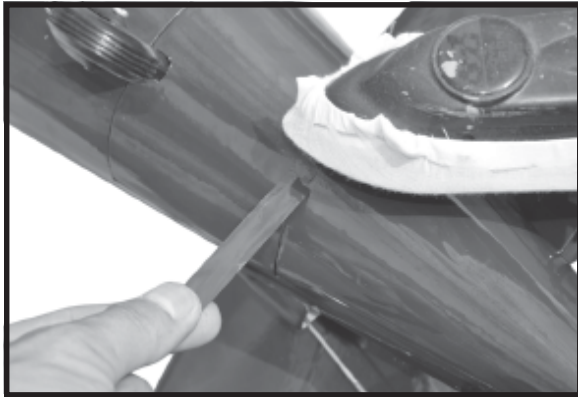
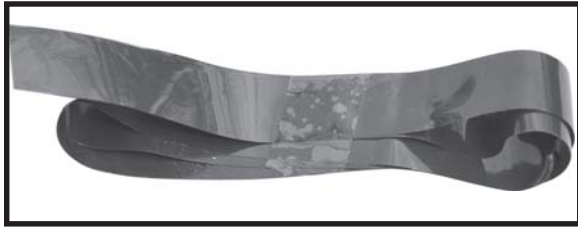

### INSTALLING SERVO USING FOR VALUE CONTROL

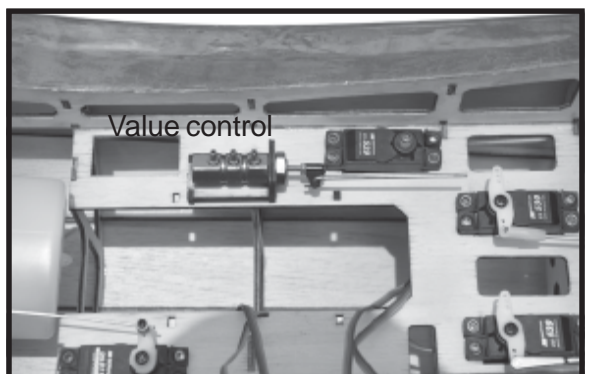
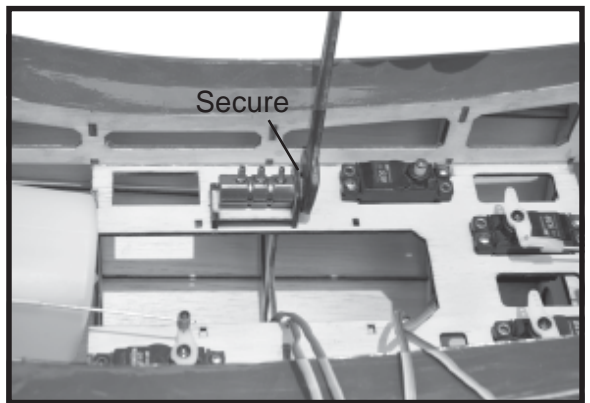
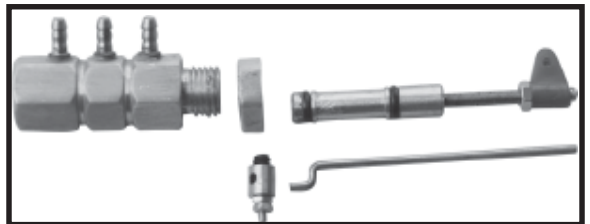
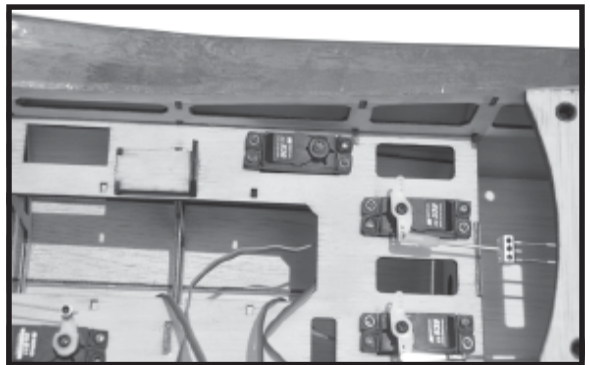
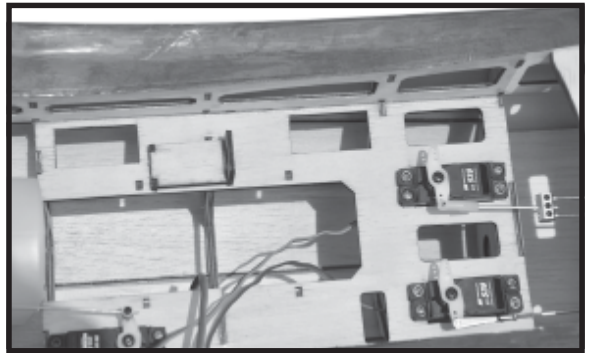



# AIR RETRACTS SYSTEM

ITEM CODE: BH77-AR

AIR UP, AIR DOWN WITH OLEO STRUTS.

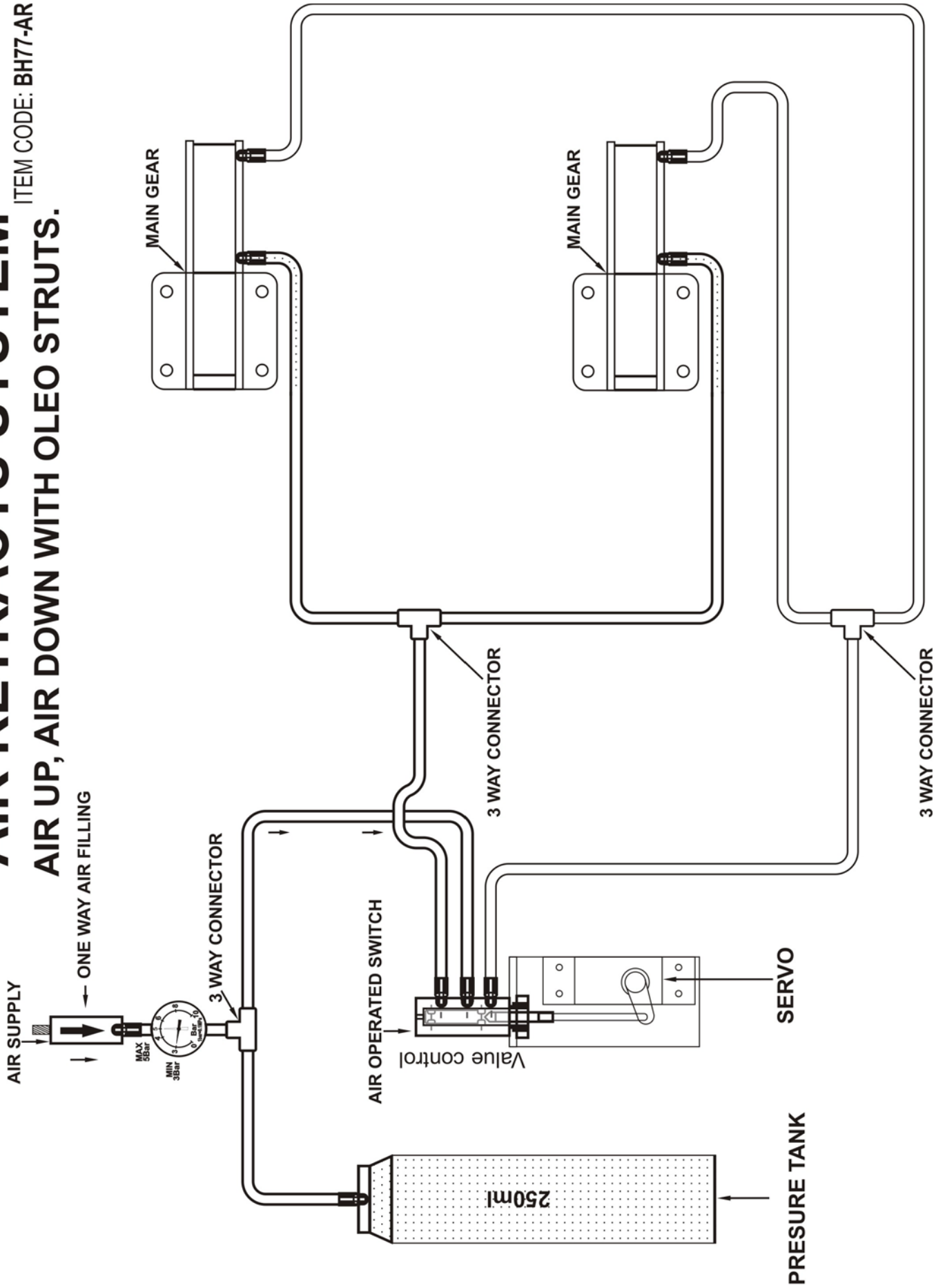



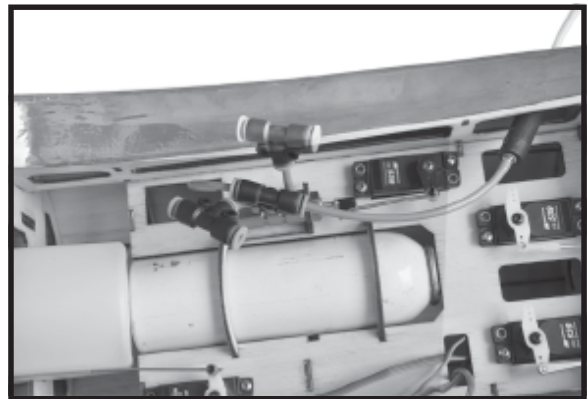
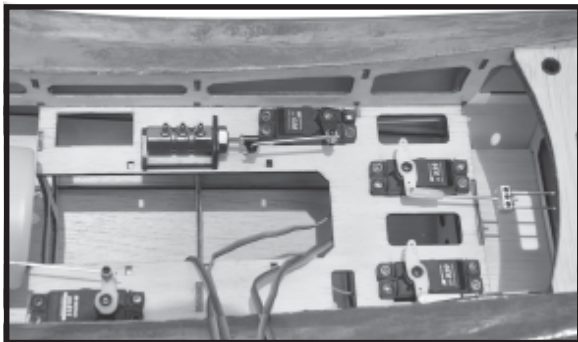
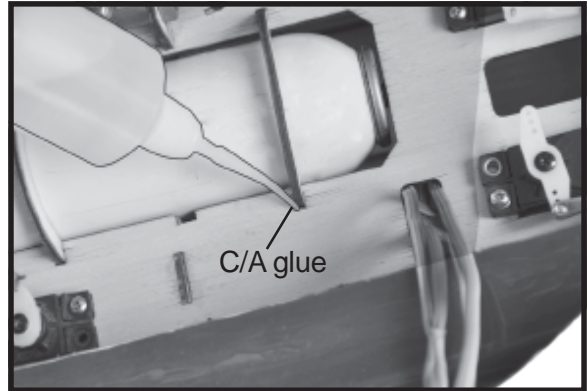
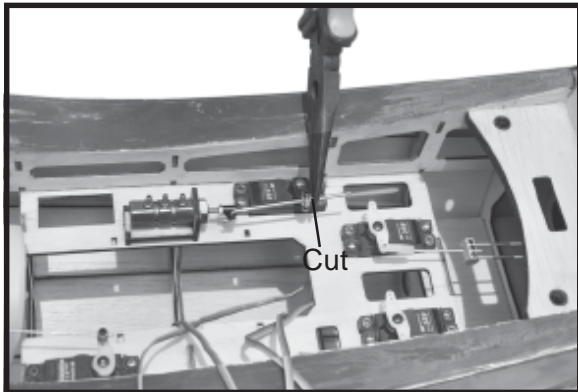
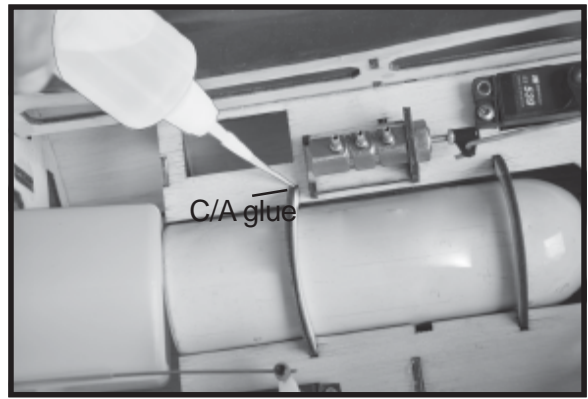
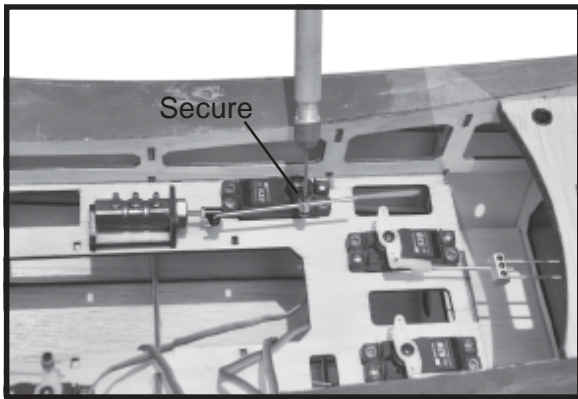

**INSTALLING AIR TANK**

**INSTALLING THE SWITCH.**

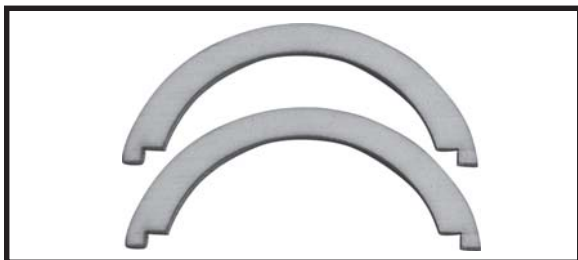

1) Cut out the switch hole using a modeling knife. Use a 2mm drill bit and drill out the two mounting holes through the fuselage side.

2) Secure the switch in place using the two machine screws provided with the radio system.

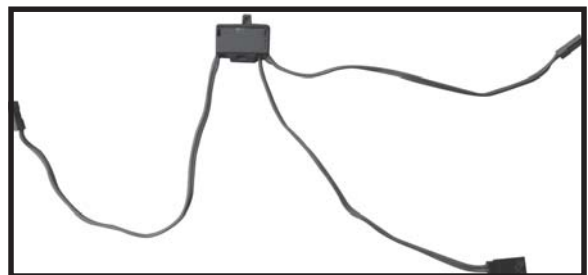
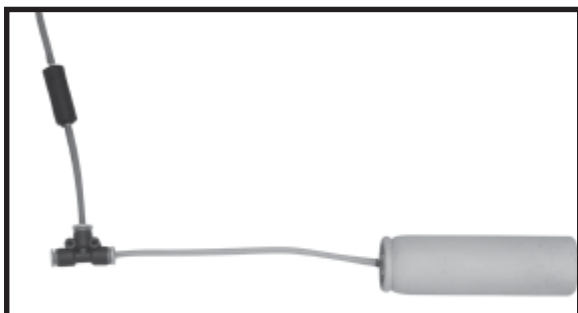

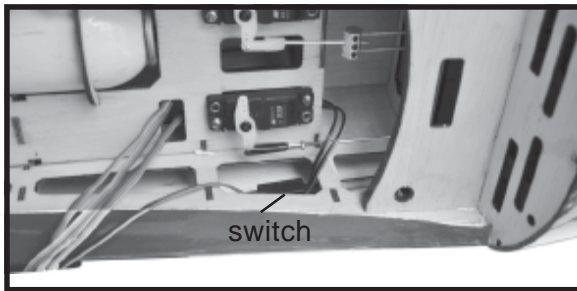

### INSTALLING THE RECEIVER.

□ 1. Plug the servo leads and the switch lead into the receiver. You may want to plug an aileron extension into the receiver to make plugging in the aileron servo lead easier when you are installing the wing. Plug the battery pack lead into the switch.

□ 2. Wrap the receiver and battery pack in the protective foam to protect them from vibration. Use a rubber band or masking tape to hold the foam in place.

□ 3. Position the battery pack and receiver behind the fuel tank. Use two tie wraps to hold the battery and receiver securely in place as pictures below

Do not permanently secure the receiver and battery until after balancing the model.

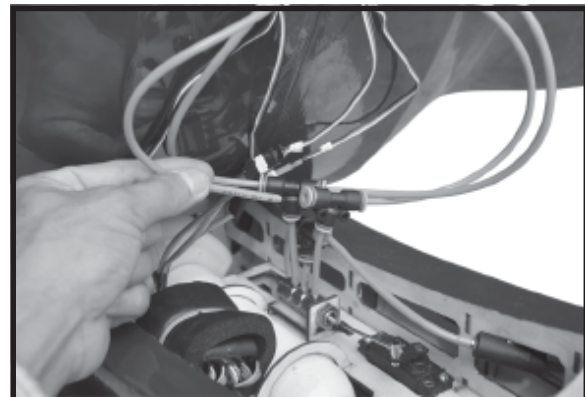
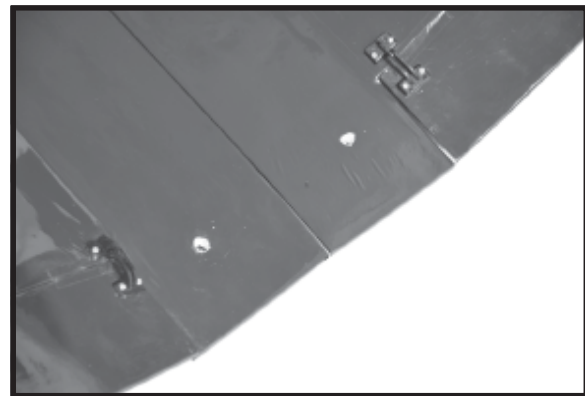
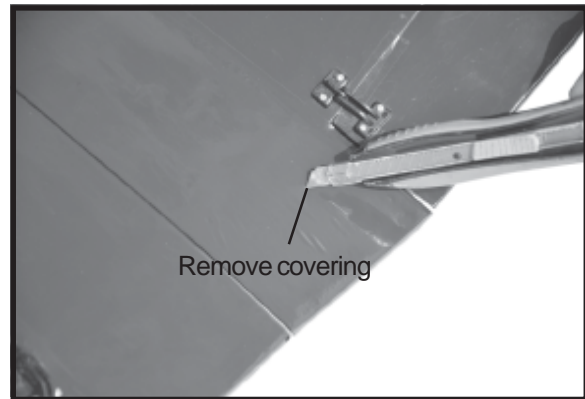
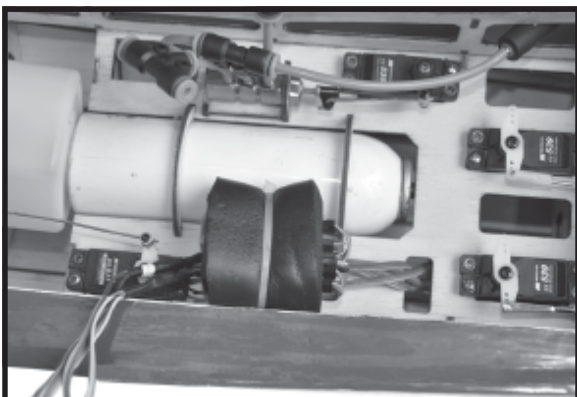
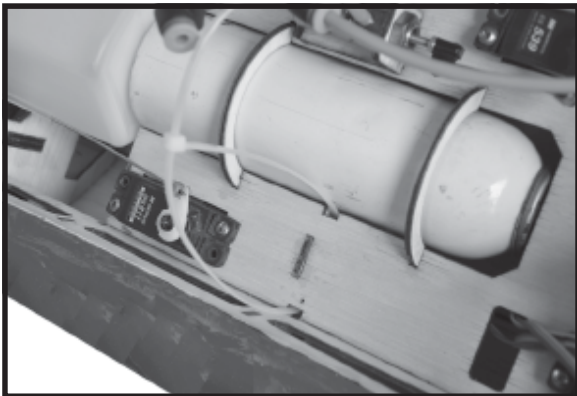

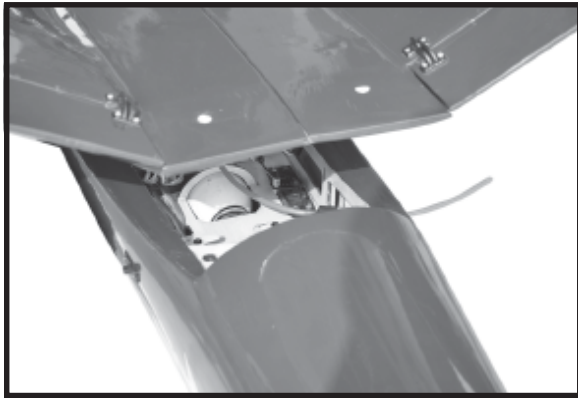

See picture wing attach to fuselage.



Installing the fuselage hatch as same as picture below.

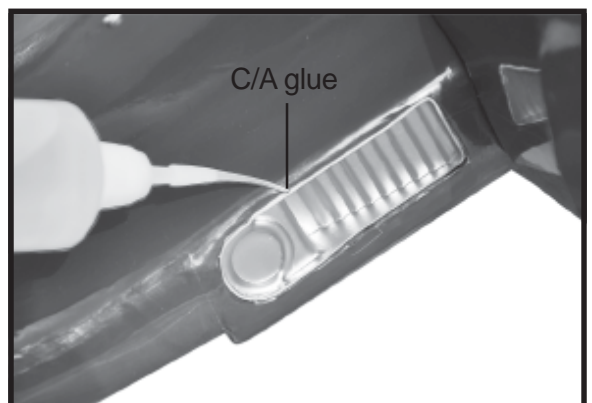
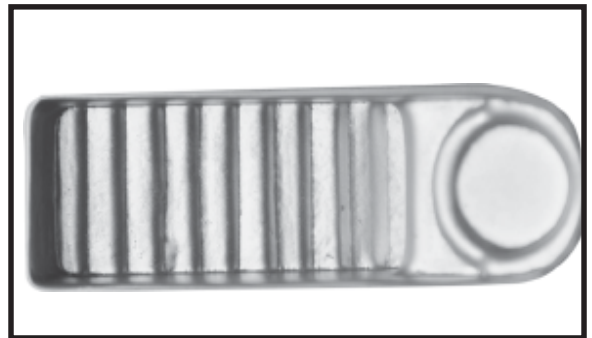
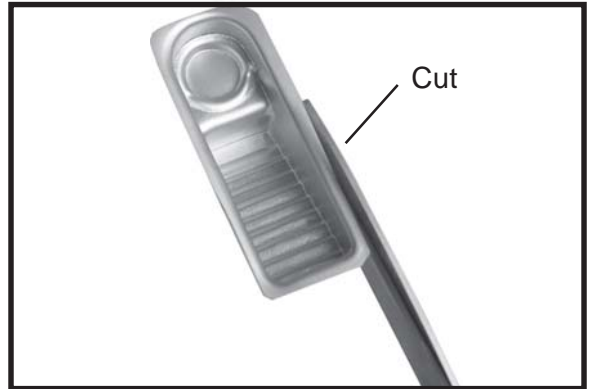
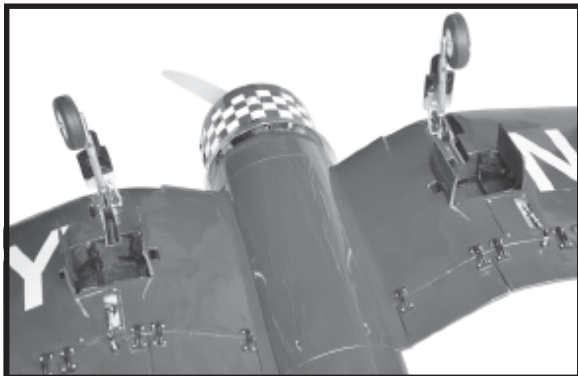



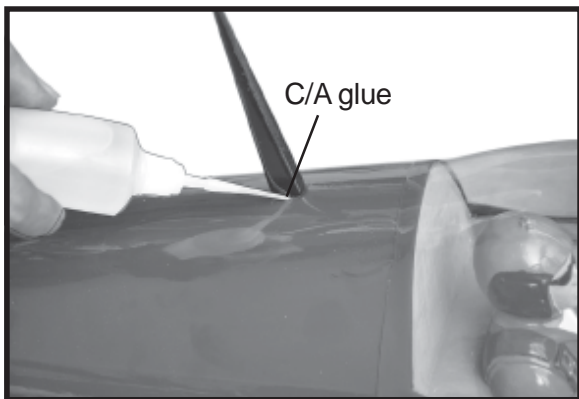

**BALANCING.**

□ 1) It is critical that your airplane be balanced correctly. Improper balance will cause your plane to lose control and crash.

THE CENTER OF GRAVITY IS LOCATED 107MM BACK FROM THE LEADING EDGE OF THE WING.

□ 2) Mount the wing to the fuselage. Using a couple of pieces of masking tape, place them on the top side of the wing 107mm back from the leading edge, at the fuselage sides.

□ 3. Turn the airplane upside down. Place your fingers on the masking tape and carefully lift the plane .

Accurately mark the balance point on the top of the wing on both sides of the fuselage. The balance point is located 107mm back from the leading edge. This is the balance point at which your model should balance for your first flights. Later, you may wish to experiment by shifting the balance up to 10mm forward or back to change the flying characteristics. Moving the balance forward may improve the smoothness and arrow-like tracking, but it may then require more speed for take off and make it more difficult to slow down for landing. Moving the balance aft makes the model more agile with a lighter and snappier "feel". In any case, please start at the location we recommend .

With the wing attached to the fuselage, all parts of the model installed ( ready to fly), and empty fuel tanks, hold the model at the marked balance point with the stabilizer level.

Lift the model. If the tail drops when you lift, the model is "tail heavy" and you must add weigh\* to the nose. If the nose drops, it is "nose heavy" and you must add weight\* to the tail to balance.

\*If possible, first attempt to balance the model by changing the position of the receiver battery and receiver. If you are unable to obtain good balance by doing so, then it will be necessary to add weight to the nose or tail to achieve the proper balance point.

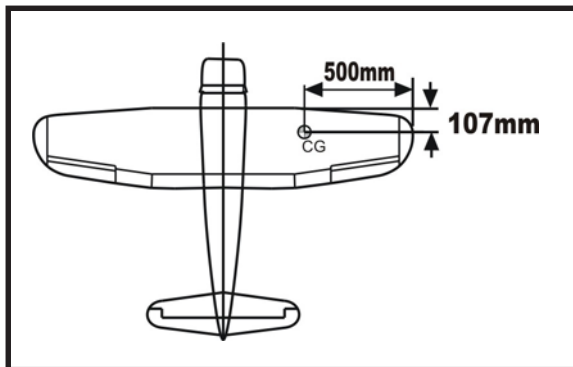

**CONTROL THROWS.**

▶ 1) We highly recommend setting up a plane using the control throws listed.

▶ 2) The control throws should be measured at the widest point of each control surface.

▶ 3) Check to be sure the control surfaces move in the correct directions.

- Ailerons : 20mm up    20mm down
- Flap     :            30mm down
- Elevator : 15mm up    15mm down
- Rudder  : 20mm right 20mm left

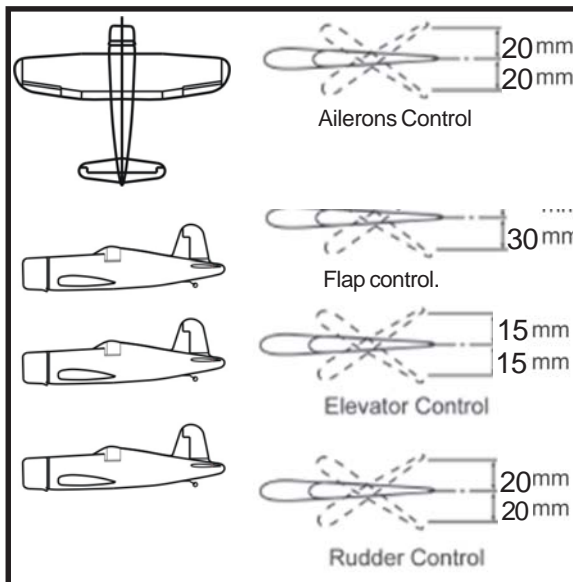



**PRE-FLIGHT CHECK.**

- ▶ 1) Completely charge your transmitter and receiver batteries before your first day of flying.
- ▶ 2) Check every bolt and every glue joint in your plane to ensure that everything is tight and well bonded.
- ▶ 3) Double check the balance of the airplane.
- ▶ 4) Check the control surface.
- ▶ 5) Check the receiver antenna . It should be fully extended and not coiled up inside the fuselage.
- ▶ 6) Properly balance the propeller.

**We wish you many safe and enjoyable flights with your CORSAIR 91.**