

Futaba

High Performance Servo

HPS-A700



HPS-A700

*BRUSHLESS
MOTOR*

		at 6.6V	at 7.4V
SPEED	(sec/60°)	0.13	0.12
TORQUE	(kgf · cm)	68.0	74.0
	(ozf · in)	944.4	1027.7

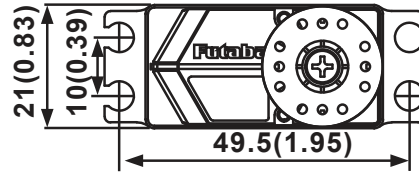

SIZE 40.5×21.0×39.4 mm
(1.59×0.83×1.55 in)

WEIGHT 82 g (2.89 oz)

RATED VOLTAGE DC6.0V~7.4V

OPERATING VOLTAGE DC4.8V~8.4V

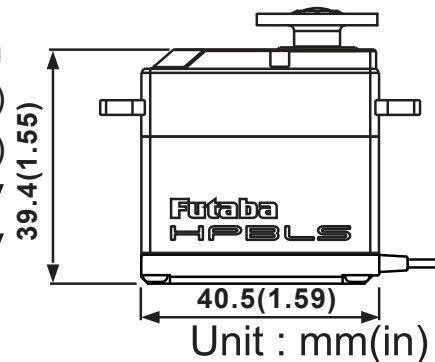

⚠ CAUTION

- No dry battery or BEC use

Unit : mm(in)

⚠ WARNING

- ❗ **Turn on the power in transmitter → receiver order. In addition, always check the operation of all the servos before flight.**
- ⊘ **Do not insert or remove the servo connector while the receiver power is ON.** Since the S.BUS2 servo switches the operation mode automatically according to the type of signal (S.BUS signal/PWM signal) from the receiver, if the connector is inserted or removed while the power is ON, an S.BUS connected servo will be incorrectly recognized and may stop.
- ⊘ **Do not leave the servo in the locked state.** Leaving the servo in the locked state (state in which enough force is applied that the servo cannot move) may cause smoke, fire, and damage.
- ⊘ **Never connect the battery in reverse.** Reverse connection may cause smoke, fire, and damage.
- ⊘ **Do not expose the servo to dust and water.** The servo does not have a waterproof construction. If it gets wet, the servo may not operate or the power supply may short circuit.
- ❗ **For the servo which has a middle case of an aluminum heat sink construction: Install the servo so that it does not touch the servo case and metal parts of the fuselage.** It will generate a large amount of noise if touched. It will become impossible to receive and is extremely dangerous.
- ❗ **When installing the servo, check PUSHROD LINKAGE to make sure there is no binding** in order to prevent excessive power consumption and decrease the life of the motor and battery.

⚠ CAUTION

- ⊘ **Do not touch the servo case immediately after servo operation.** You may be burned because the motor and circuits inside the servo become hot.
- ⊘ **Do not turn the servo horn with unreasonable force.** The servo may be damaged.
- ⊘ **Do not disassemble or modify the servo.** The servo has a precision construction. Futaba Corp. will not be responsible for any disassembly or modification other than those specified by us.
- ⊘ **Do not drop the servo or expose it to strong shocks or vibrations.** It will damage with a shock.
- ❗ **Use the servo as an actuator in hobby applications.** Futaba will not be responsible if the servo is used in applications other than the above.

Futaba will not be responsible for damage, etc. caused by the use of parts other than Genuine Futaba parts.

• Power supply

This servo is designed to be used with models which require especially high torque and high speed. For this reason, a large current flows during servo operation. Therefore, decide the safe number of uses by paying careful attention to the remaining battery capacity. Use the battery as specified. Use a battery with an ample margin as the power supply. This servo cannot use BEC, voltage regulator and dry cell battery. Even if using a receiver with the BATTERY FAIL SAFE function, it may not operate correctly. Therefore always check the battery voltage and charge the battery quickly. When using 5 or more servos for large scale models, use a separate power supply.

• Servo Horn

Please use an optional aluminum arm, when you use large scale models. Attached resin arms will be damaged because of the intensity shortage. Also, please use the attached LOCK-SCREW. Ordinary screw will become loose and come off of the servo from the vibration.

• System use

For full performance, 2.4GHz system is recommended.

• Programming function

This servo can be connected to a PC by using the CIU-2/3 USB Adapter sold separately and its various operating characteristics can be changed as a programmable servo by means of dedicated software "S-Link". S-Link is downloadable from a Futaba WEB site. However, channel setting and other operating characteristics settings cannot be made with the existing S.BUS PC Link software. When you use a transmitter with an S.BUS setting function. By connecting a servo to the S.BUS setting connector of the transmitter, a program setup of a servo can be performed on the screen of a transmitter. This servo does not have stop mode function. Therefore becomes as [hold] when the input signal of a servo stops. Depending on a setup, a servo carries out vibration. If a servo continues carrying out vibration, it will break, please restore a setup.

• Soft start

In order to protect the linkage, only the first operation when the power is turned on moves the servo to the specified position slowly. When a new control signal enters while the soft start is operating, it become normal operation at once.

[Servo Mounting Precautions]

Use attached dampers and eyelets correctly.

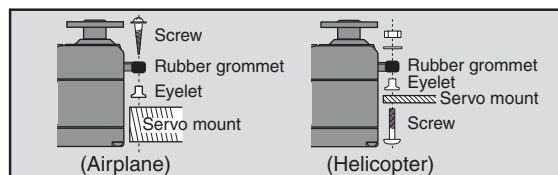

About the S.BUS/S.BUS2 system

S.BUS2

Using the S.BUS2 port an impressive array of telemetry sensors may be utilized. This servo is connectable with the both sides of S.BUS and S.BUS2 port.

S.BUS2 servo → it can be used in S.BUS2 and S.BUS port.
S.BUS servo → it cannot be used in S.BUS2 port.

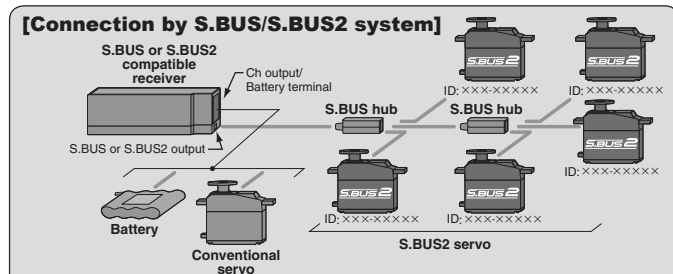

- * Can also be used together with conventional servos.
- * **Items required:** S.BUS or S.BUS2 receiver, S.BUS2 servo, S.BUS hub, S.BUS channel setting tool (・ S.BUS channel setup compatible transmitter・ SBC-1・ CIU-2/3・ S.BUS channel setup compatible receiver)

[Procedure for use with the S.BUS/S.BUS2 system]

1. **Set the channel at the S.BUS2 servos.**
Set the channel at the S.BUS2 servos by using an S.BUS channel setting tool.
* Refer to the S.BUS channel setting tool instruction manual for the S.BUS servo channel setting method.
2. **Connect the servos to an S.BUS or S.BUS2 compatible receiver.**
Connect the servos from the S.BUS or S.BUS2 port of the S.BUS or S.BUS2 compatible receiver via S.BUS hubs.

What is S.BUS?

Different from conventional radio control systems the S.BUS system uses data communication to transmit control signals from a receiver to a servo, gyro, or other S.BUS compatible device. This data includes commands such as "move the channel 3 servo to 15 degrees, move the channel 5 servo to 30 degrees" to multiple devices. The S.BUS devices execute only those commands for their own set channel. For this reason, it can be used by connecting multiple servos to the same signal line. Many S.BUS servos is in the connected state, one servo of them can be set it up. The ID code of each servo is used for it. ID code is indicated on the seal of the case. After carrying in a model, it is convenient, if you use attached ID seal and CH seal when ID cannot be seen.

[Connection to conventional receiver]

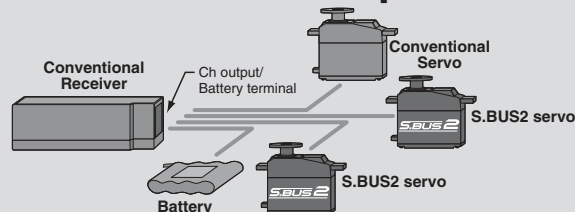

* Operation is the same as that of a conventional servo.

[Operation by conventional radio control]

An S.BUS2 servo connected to a conventional receiver operates as a conventional servo. The channel becomes the receiver connection point.

*The contents set by programmable function are effective.

HPS-A700 Servo for Large aerobatics plane

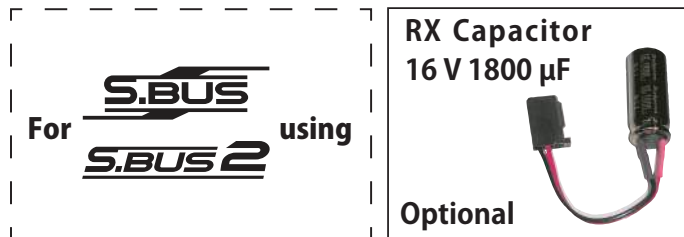

This servo is designed to be used with models which require especially high torque and high speed. In the case of more intense operations, the power supply line become unstable and there is a possibility of malfunctioning. As a countermeasure, by using the RX capacitor 16 V 1800 μF manufactured by Futaba, instantaneous voltage drop can be avoided.

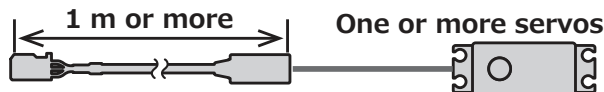

When using S.BUS system with extension cord of 1 m or more with one or more servos, be sure to use the RX capacitor 16 V 1800 μF for safety. Likewise, attach capacitors to other servos with common power supply.

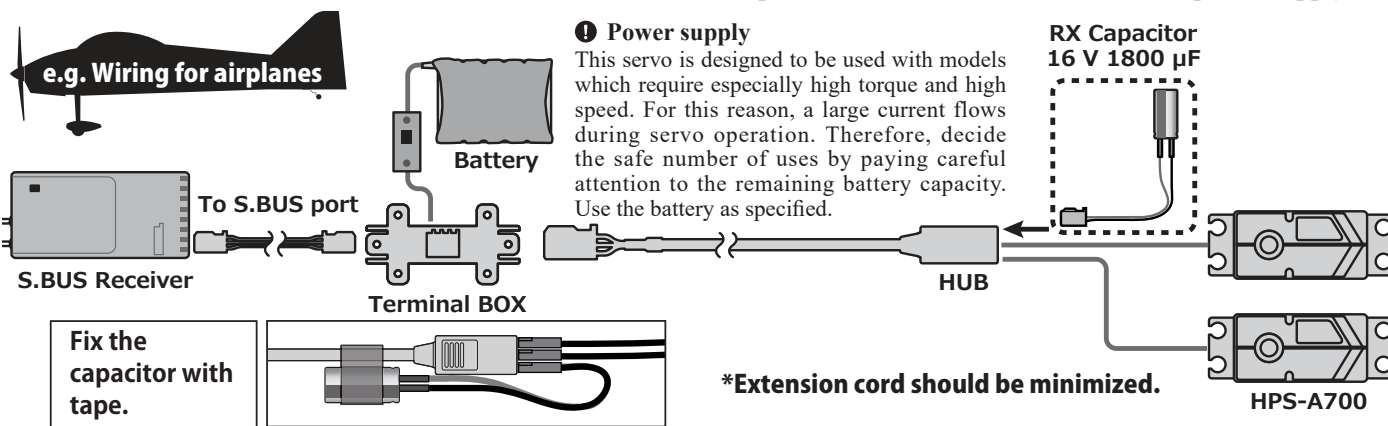

HPS-A700 Servo Usage Precautions

● Caution!!

HPS-A700 is a super powerful servo combining high speed and high power. When using on high load applications which cannot move as fluidly in fast situations, such as the rudder, please set the servo parameters to below.

	Default	Rudder
Damper factor	115	144
Stretcher gain	1.00	0.75